

Cisco CHS 435HDC High-Definition Set-Top with Multi-Stream CableCARD (M-Card) Interface



Notice to Installers

The servicing instructions in this notice are for use by qualified service personnel only. To reduce the risk of electric shock, do not perform any servicing other than that contained in the operating instructions, unless you are qualified to do so.

Note to System Installer

For this apparatus, the coaxial cable shield/screen shall be grounded as close as practical to the point of entry of the cable into the building. For products sold in the US and Canada, this reminder is provided to call the system installer's attention to Article 820-93 and Article 820-100 of the NEC (or Canadian Electrical Code Part 1), which provides guidelines for proper grounding of the coaxial cable shield.



This symbol is intended to alert you that uninsulated voltage within this product may have sufficient magnitude to cause electric shock. Therefore, it is dangerous to make any kind of contact with any inside part of this product.

Ce symbole a pour but d'alerter toute personne qu'un contact avec une pièce interne de ce produit, sous tension et non isolée, pourrait être suffisant pour provoquer un choc électrique. Il est donc dangereux d'être en contact avec toute pièce interne de ce produit.



CAUTION: To reduce the risk of electric shock, do not remove cover (or back). No user-serviceable parts inside. Refer servicing to qualified service personnel.

WARNING
TO PREVENT FIRE OR ELECTRIC SHOCK, DO NOT
EXPOSE THIS UNIT TO RAIN OR MOISTURE.



This symbol is intended to alert you of the presence of important operating and maintenance (servicing) instructions in the literature accompanying this product.

Ce symbole a pour but de vous avertir qu'une documentation importante sur le fonctionnement et l'entretien accompagne ce produit.

Contents

IMPORTANT SAFETY INSTRUCTIONS	4
Welcome	6
Safety First	6
Identify Your Set-Top with the Serial Number	6
In This Manual	6
Front Panel	7
Back Panel	8
Connecting the Set-Top	9
Connecting to the In-Home Network	10
Connections for a High-Definition TV (HDTV)	11
Connections for a Standard-Definition TV (SDTV)	12
Connections for a VCR or DVD Recorder	13
Connecting an Over-the-Air Converter Box	13
Connecting to an HDTV with an HDMI Connector	14
Connecting to an HDTV with a DVI Connector	15
Connecting to an HDTV with Component (YPbPr) Connectors	16
Connecting to an HDTV with a 1394 Connector	17
Connecting to an SDTV with Component (YPbPr) Connectors	18
Connecting to an SDTV with an S-Video Connector	19
Connecting to an SDTV with an RCA-Type Connector	20
Connecting to an SDTV with a Coaxial Cable	21
Connecting to a Home Theater System with Component (YPbPr) Connectors	22
Connecting to a Home Theater System and a DVD Player with Component (YPbPr) Connectors	23
Connecting to a Stereo VCR or DVD Recorder	25
Connecting to an External SATA Hard Disk Drive	26
Troubleshooting	28
Avoid Screen Burn-In	28
Frequently Asked Questions	29
Picture Formats	30
Index	31
Compliance Information	33

IMPORTANT SAFETY INSTRUCTIONS

- 1) Read these instructions.
- 2) Keep these instructions.
- 3) Heed all warnings.
- 4) Follow all instructions.
- 5) Do not use this apparatus near water.
- 6) Clean only with dry cloth.
- 7) Do not block any ventilation openings. Install in accordance with the manufacturer's instructions.
- 8) Do not install near any heat sources such as radiators, heat registers, stoves, or other apparatus (including amplifiers) that produce heat.
- 9) Do not defeat the safety purpose of the polarized or grounding-type plug. A polarized plug has two blades with one wider than the other. A grounding-type plug has two blades and a third grounding prong. The wide blade or the third prong are provided for your safety. If the provided plug does not fit into your outlet, consult an electrician for replacement of the obsolete outlet.
- 10) Protect the power cord from being walked on or pinched particularly at plugs, convenience receptacles, and the point where they exit from the apparatus.
- 11) Only use attachments/accessories specified by the manufacturer.
- 12)  Use only with the cart, stand, tripod, bracket, or table specified by manufacturer, or sold with the apparatus. When a cart is used, use caution when moving the cart/apparatus combination to avoid injury from tip-over.
- 13) Unplug this apparatus during lightning storms or when unused for long periods of time.
- 14) Refer all servicing to qualified service personnel. Servicing is required when the apparatus has been damaged in any way, such as a power-supply cord or plug is damaged, liquid has been spilled or objects have fallen into the apparatus, the apparatus has been exposed to rain or moisture, does not operate normally, or has been dropped.

Power Source Warning

A label on this product indicates the correct power source for this product. Operate this product only from an electrical outlet with the voltage and frequency indicated on the product label. If you are uncertain of the type of power supply to your home or business, consult your service provider or your local power company.

The AC inlet on the unit must remain accessible and operable at all times.

Ground the Product



WARNING: Avoid electric shock and fire hazard!
If this product connects to coaxial cable wiring, be sure the cable system is grounded (earthed). Grounding provides some protection against voltage surges and built-up static charges.

Outdoor Grounding System

If this product connects to an outdoor antenna or cable system, be sure the antenna or cable system is grounded (earthed). This provides some protection against voltage surges and built-up static charges.

Article 810 of the National Electric Code (NEC) ANSI/NFPA No. 70-1990, provides the following information:

- Grounding of the mast and supporting structure
- Grounding the lead-in wire to an antenna discharge unit
- Size of the grounding conductors
- Location of the antenna-discharge unit
- Connection to grounding electrodes
- Requirements for the grounding electrodes (see the following antenna grounding diagram as recommended by NEC ANSI/NFPA 70)



WARNING: Avoid electric shock and fire hazard!
Do not locate an outside antenna system in the vicinity of overhead power lines or power circuits. Touching power lines or circuits might be fatal.

Example Of Antenna Grounding

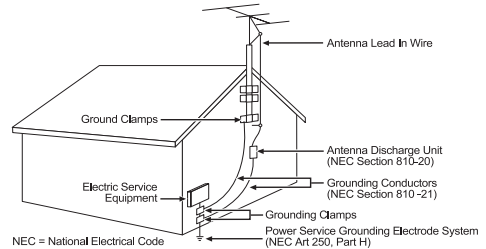

T11518

Protect the Product from Lightning

In addition to disconnecting the AC power from the wall outlet, disconnect the signal inputs.

Verify the Power Source from the On/Off Power Light

When the on/off power light is not illuminated, the apparatus may still be connected to the power source. The light may go out when the apparatus is turned off, regardless of whether it is still plugged into an AC power source.

Eliminate AC Mains Overloads



WARNING: Avoid electric shock and fire hazard!
Do not overload AC mains, outlets, extension cords, or integral convenience receptacles. For products that require battery power or other power sources to operate them, refer to the operating instructions for those products.

IMPORTANT SAFETY INSTRUCTIONS, continued

Handling Disposable Batteries

This product may contain disposable batteries. Heed the following warning and follow the Battery Safety and Battery Disposal instructions below.



WARNING: There is danger of explosion if the battery is mishandled or incorrectly replaced. Replace only with the same type of battery. Do not disassemble it or attempt to recharge it outside the system. Do not crush, puncture, dispose of in fire, short the external contacts, or expose to water or other liquids. Dispose of the battery in accordance with local regulations and instructions from your service provider.

Battery Safety

- Insert batteries correctly. There may be a risk of explosion if the batteries are incorrectly inserted.
- Do not attempt to recharge 'disposable' or 'non-reusable' batteries.
- Please follow instructions provided for charging 'rechargeable' batteries.
- Replace batteries with the same or equivalent type that we recommend.
- Do not expose batteries to excessive heat (such as sunlight or fire).
- Do not expose batteries to temperatures above 100°C (212°F).

Battery Disposal

- The batteries may contain substances that could be harmful to the environment.
- Recycle or dispose of batteries in accordance with the battery manufacturer's instructions and local/national disposal and recycling regulations.



廢電池請回收

- The batteries may contain perchlorate, a known hazardous substance, so special handling and disposal of this product might be necessary. For more information about perchlorate and best management practices for perchlorate-containing substance, see www.dtsc.ca.gov/hazardouswaste/perchlorate

Provide Ventilation and Select a Location

- Remove all packaging material before applying power to the product.
- Do not place this apparatus on a bed, sofa, rug, or similar surface.
- Do not place this apparatus on an unstable surface.
- Do not install this apparatus in an enclosure, such as a bookcase or rack, unless the installation provides proper ventilation.
- Do not place entertainment devices (such as VCRs or DVDs), lamps, books, vases with liquids, or other objects on top of this product.
- Do not block ventilation openings.

Protect from Exposure to Moisture and Foreign Objects



WARNING: Avoid electric shock and fire hazard! Do not expose this product to dripping or splashing liquids, rain, or moisture. Objects filled with liquids, such as vases, should not be placed on this apparatus.



WARNING: Avoid electric shock and fire hazard! Unplug this product before cleaning. Do not use a liquid cleaner or an aerosol cleaner. Do not use a magnetic/ static cleaning device (dust remover) to clean this product.



WARNING: Avoid electric shock and fire hazard! Never push objects through the openings in this product. Foreign objects can cause electrical shorts that can result in electric shock or fire.

Service Warnings



WARNING: Avoid electric shock! Do not open the cover of this product. Opening or removing the cover may expose you to dangerous voltages. If you open the cover, your warranty will be void. This product contains no user-serviceable parts.

Check Product Safety

Upon completion of any service or repairs to this product, the service technician must perform safety checks to determine that this product is in proper operating condition.

Protect the Product When Moving It

Always disconnect the power source when moving the apparatus or connecting or disconnecting cables.

20090915_Cable_Safety

Welcome

The Cisco® CHS 435HDC High-Definition Set-Top (CHS 435HDC) with Multi-Stream CableCARD™ (M-Card™) Interface receives and delivers digital signals, and it delivers high-definition programming in exceptional picture and audio quality. Use the simple user interface to access favorite channels and parental control services. Contact your service provider for information about these and other available services. Use the instructions in this guide to install the CHS 435HDC and to access your program services.

The consumer support website provides news and information about this product. For more information, please refer to: <http://www.cisco.com/web/consumer/support/index.html>

Safety First

Before using the set-top, read the Important Safety Instructions section of this manual.

Identify Your Set-Top with the Serial Number

At times your service provider may ask for the serial number. To find the serial number for your set-top, look on the bottom of the set-top for the label. The serial number is a 9-digit numeric code to the right of the letters “STB SN” on the label.

Use the space provided here to record the serial number:

In This Manual

This manual covers the information you need to connect your set-top to both your in-home network and your entertainment system. The manual also outlines certain safeguards and installation information. The safety information contained in this manual was developed and provided solely by the set-top manufacturer, Cisco Systems, Inc.

Front Panel

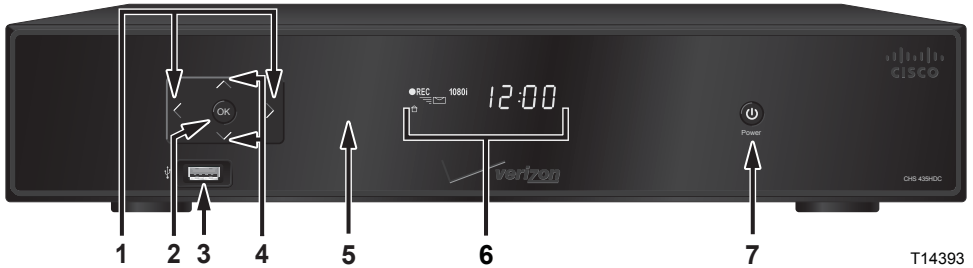

T14393

- 1 **VOL-, VOL+** Decreases and increases the volume
- 2 **OK** Selects the current item
- 3 **USB** Connects to external equipment such as a keyboard or a mouse, software controlled
- 4 **CH+, CH-** Scrolls up and down through the channels
- 5 **IR Sensor** Receives the infrared signal from the remote control
- 6 **Display** Displays the selected channel number and time of day. The display shows the following:
 - Power (⏻)
 - Message (✉)
 - Record (●REC)
 - MoCA™ Link (📶)
 - HDTV
 - Auto
 - 480i / 480P
 - 720i / 720P
 - 1080i / 1080P
 - 5.1
- 7 **Power** Turns the set-top on and off

Note: This illustration may vary from the actual product.



CAUTION: The DVR is equipped with a hard disk drive to store programs that you record and to allow you to rewind and pause live TV. Any time the DVR is powered on (power LED is illuminated) or a recording is in progress (the record LED is illuminated) the hard disk is in use.

If you need to move the DVR, complete the following steps to allow the hard disk to shut down properly. First, make sure that no recording is in progress (record LED is off). Then, turn off power by pressing the **Power** key. Finally, unplug the unit and wait 10 seconds for the hard disk drive to spin down (stop). At this point the unit can be moved safely.

You should handle this product with the same level of care you would use when handling other electronics containing a hard disk drive, such as a laptop computers or other hard disk drive equipped devices.

Back Panel

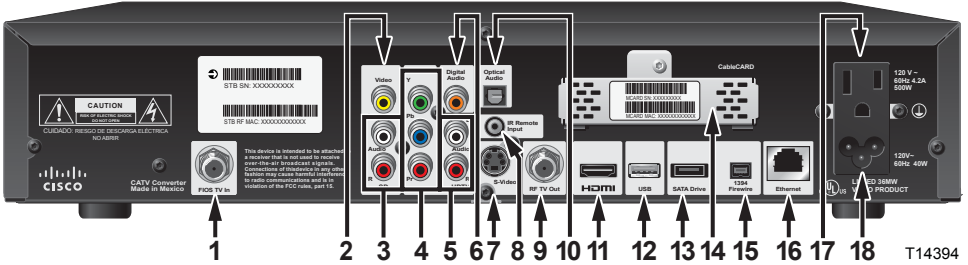

- 1 FiOS TV In** Connects to a coaxial cable that delivers the signal from your service provider
- 2 Video Out** Connects to the composite input on your TV
- 3 Audio Out** Connects to RCA cables that send analog audio signals (left and right) to the stereo inputs on a TV
- 4 HDTV (YPbPr)** Connects to the component input (YPbPr) on the HDTV
- 5 Audio Out** Connects to RCA cables that send analog audio signals (left and right) to the stereo inputs on a TV
- 6 Digital Audio Out** Connects to an RCA cable that sends a digital audio signal to a surround-sound receiver or other digital audio device input
- 7 S-Video Out** Connects to an S-Video cable that sends an S-Video signal to your TV or VCR. This signal is standard definition, but higher quality than other SDTV connections
- 8 IR Remote Input** Available to be connected to an approved remote IR receiver (purchased separately)
- 9 RF TV Out** Connects to a coaxial cable that sends analog audio and video signals to a TV or VCR
- 10 Optical Audio Out** Connects to an optical cable that sends a digital audio signal to a surround-sound receiver or other digital audio device input
- 11 HDMI 1.3** Connects an HDMI™ cable to the HDMI input of an HDTV. HDMI supports both digital audio and video. May be used to connect to a DVI interface using an HDMI-to-DVI adapter for video and separate audio connections. Any of the following audio connections may be used: Audio Out (3 or 5); Digital Audio Out (6); or Optical Audio Out (10)
- 12 USB 2.0** Connects to external USB equipment approved by your service provider
- 13 SATA** Connects to an external Serial ATA (eSATA) hard disk drive for expanded drive space. A connected eSATA drive is not an archival device. Ask your service provider for a list of approved hard drive models for use with the DVR
- 14 CableCARD** Slot for CableCARD module, which decrypts subscription digital channels. This set-top will not operate correctly without a CableCARD module, which is installed by your service provider
- 15 IEEE 1394** Connects to display devices that are equipped with a 1394 input
- 16 Ethernet** Connects to external Ethernet equipment approved by your service provider
- 17 AC Outlet** Connects to the AC power cord from another device, such as a TV
- 18 AC Power Input** Connects to the power cord to deliver power to the set-top

Note: This illustration may vary from the actual product.

Connecting the Set-Top

To connect your set-top to your network and home entertainment devices, complete these steps.



Because the connections for a high-definition (HD) or standard-definition (SD) TV are different, you must determine if your TV is HD or SD. Your TV must receive HD signals for you to enjoy the benefits of HDTV. Refer to the manual that came with your TV for more information.

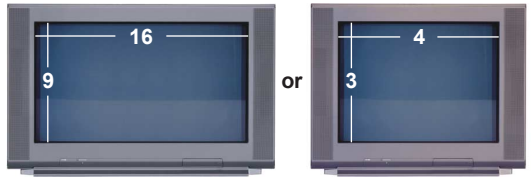

See page 30 for more information on picture formats.



Make one of the following connections for your home network:

- If your home network uses coaxial cable, use the FiOS TV connector on the set-top. **See page 10.**
- If your home network uses Ethernet (CAT-5) cable, use the Ethernet connector on the set-top. **See page 10.**

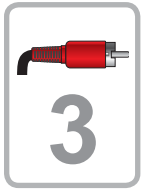

Make the connections for your TV, VCR, and DVD recorder as follows:

- If you are using an HDTV, **see page 11** and the connection diagrams in this manual.
- If you are using an SDTV, **see page 12** and the connection diagrams in this manual.
- If you want to record some programs on VCR tape or DVD, **see page 13** and the connection diagrams in this manual.



Identify the additional consumer electronic devices you will connect to the set-top and TV. **See pages 14 through 27** and refer to the user manual for the device.



Plug the set-top and the TV into an AC power source that is not controlled by a switch. For further instructions on completing the setup, refer to information from your service provider.

Connecting to the In-Home Network

The following diagrams illustrate examples of the connections you can use to connect your set-top to your in-home network. Contact your service provider for the recommended connection method for your home.

Note: The illustrations below may vary from the actual product.

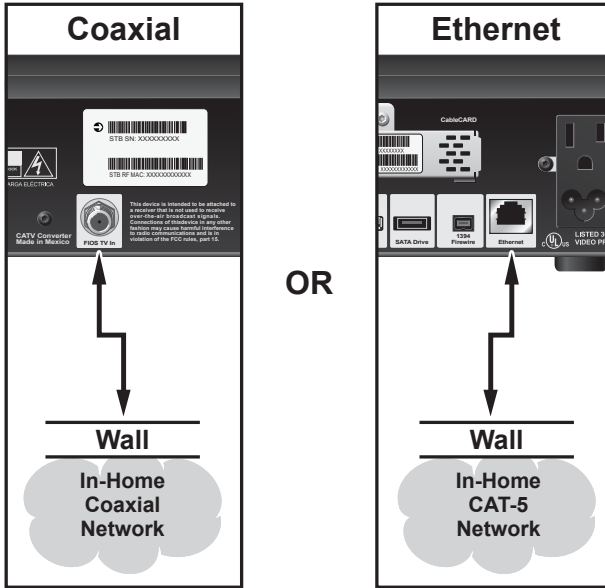

T14395

WARNING: The Ethernet port of this equipment is suitable for connection to intra-building or unexposed wiring or cabling only. The Ethernet port of this equipment **MUST NOT** be metallically connected to interfaces that connect to the OSP (OutSide Plant) or its wiring. The Ethernet port is designed for use as an intra-building interface only (Type 2 or Type 4 ports as described in GR-1089-CORE, Issue 4) and requires isolation from the exposed OSP cabling. The addition of Primary Protectors is not sufficient protection in order to connect these interfaces metallically to OSP wiring.

Connections for a High-Definition TV (HDTV)



















To use the set-top with an HDTV, you must make *one* of the following connections to view the HD content. Refer to the user manual for your TV and the cabling diagrams in this manual for more detailed connection information.

Although all connections provide you with quality service, we list the connections in our recommended order.

Notes:

- The labeling on your set-top or HDTV may vary slightly from the illustrations shown below.
- Some cables shown in the connection diagrams may not be included with this set-top.
- Set the HD mode and select the output video format (480i, 720p, 1080i) on the set-top.

See page 30 for more information on picture formats.

Use One of These Required Connections to an HDTV		Set-Top Connections	HDTV Connections
HDMI	<p>Some HDTVs have a High-Definition Multimedia Interface (HDMI) connector. The HDMI connector provides both a digital video and audio connection. See the connection diagram on page 14 for an example.</p> <p>Note: The HDMI port on the TV must support high-bandwidth digital content protection (HDCP).</p>	 HDMI	Audio/Video  HDMI
DVI	<p>The HDMI connector can provide the connection to an HDTV with a DVI input. If your HDTV has a Digital Visual Interface (DVI) connector, you need an HDMI-to-DVI adapter, and a separate audio connection (either L/R or optical audio).</p> <p>Note: The DVI port on the TV must support high-bandwidth digital content protection (HDCP). See the connection diagram on page 15 for an example.</p>	 HDMI Adapter Needed	Video  DVI
		Audio  Audio HDTV R L  Optical Audio	 L R  OPTICAL INPUT
YPbPr	<p>The YPbPr (red, blue, and green) connectors provide high-definition component video signals to an HDTV, and a separate audio connection (either L/R or optical audio).</p> <p>See the connection diagram on page 16 for an example.</p>	Video  Y Pb Pr L R HDTV R L Audio HDTV R L Optical Audio  Optical Audio	Video  Y Pb Pr  L R  OPTICAL INPUT
		Audio  Audio HDTV R L	 OPTICAL INPUT
RGB	<p>Some HDTVs have only RGB or RGB-HV connectors. If you have one of these HDTVs, you need a Component-to-RGB adapter, and you need a separate audio connection.</p>	Video  Y Pb Pr Adapter Needed	Video  R G B H V
		Audio  Audio HDTV R L	 L R















Connections for a Standard-Definition TV (SDTV)

When using the set-top with an SDTV, you must make *one* of the following connections to view content. Some SDTVs may not have all these connections. Refer to the user manual for your TV and the cabling diagrams in this manual for more detailed information.

Although all connections provide you with quality service, we list the connections in our recommended order.

Notes:

- The labeling on your set-top or SDTV may vary slightly from the illustrations shown below.
- Some cables shown in the connection diagrams may not be included with this set-top.

Use One of These Required Connections to an SDTV		Set-Top Connections		SDTV Connections
YPbPr	<p>The YPbPr (red, blue, and green) connectors can provide standard-definition component video signals to an SDTV. A separate audio connection is also needed.</p> <p>See the connection diagram on page 18 for an example.</p> <p>Note: To connect YPbPr to an SDTV, you must select the output video format. See page 30 for more information on picture formats.</p>		Video	
			Audio	
S-Video	<p>The S-Video connection provides an optimal video connection to SDTVs. A separate audio connection is also needed.</p> <p>See the connection diagram on page 19 for an example.</p>		Video	
			Audio	
SD Video	<p>The SD Video connector provides a video connection to an SDTV. A separate audio connection is also needed.</p> <p>See the connection diagram on page 20 for an example.</p>		Video	
			Audio	
RF TV Out	<p>The RF TV Out connector provides both a video and audio connection to an SDTV.</p> <p>See the connection diagram on page 21 for an example.</p>		Audio/Video	





Connections for a VCR or DVD Recorder

When using the set-top with a VCR or DVD recorder, you must make *one* of the following connections to view content.

Although all connections provide you with quality service, we list the connections in our recommended order.

Notes:

- The labeling on your set-top, VCR, or DVD recorder may vary slightly from the illustrations shown below.
- Some cables shown in the connection diagrams may not be included with this set-top.

Use One of These Optional Connections to a VCR or DVD Recorder		Set-Top Connections		VCR/DVD Recorder Connections
VCR/DVD Recorder	For VCRs or DVD recorders with S-Video In and Left and Right audio connectors, use the S-Video and the SD Audio Left and Right connectors on the set-top.	 S-Video	Video	 S-VIDEO IN
		 L Audio R SD		Audio
	For VCRs or DVD recorders with Video In and Left and Right audio connectors, use the SD Video and the SD Audio connectors (Left and Right) on the set-top. See the connection diagram on page 25 for an example.	 Video	Video	
		 L Audio R SD		Audio

Connecting an Over-the-Air Converter Box

You can connect an over-the-air converter box directly to your TV to receive certain local channels, but do not connect the over-the-air converter box directly to your set-top.

Connecting to an HDTV with an HDMI Connector

Cables Used in this Configuration

- 1 Coaxial Cable
- 1 HDMI Cable

Notes:

- The HDMI port on the TV must support high-bandwidth digital content protection (HDCP).
- The HDMI interface supports Dolby™ Digital 5.1 audio.



WARNING:

Electric shock hazard! Unplug all electronic devices before connecting or disconnecting any device cables to the set-top.

CHS 435HDC

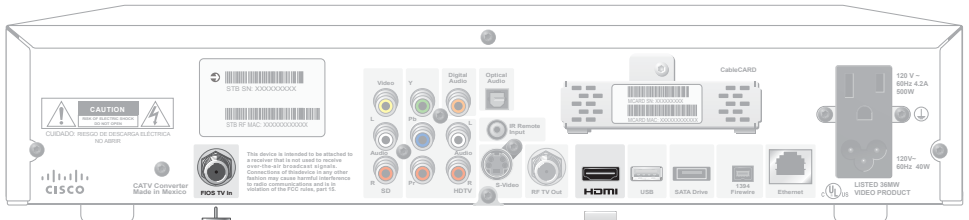

FiOS TV
Input

Back of
HDTV

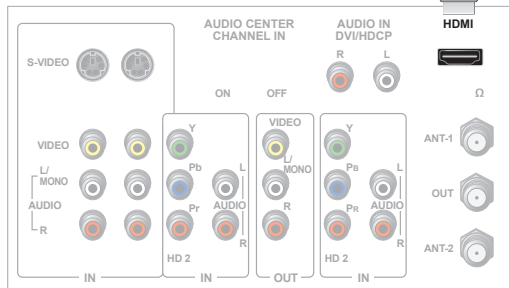

T14396

Connecting to an HDTV with a DVI Connector

Cables Used in this Configuration

- 1 Coaxial Cable
- 1 HDMI-to-DVI Cable or 1 HDMI Cable and 1 HDMI-to-DVI Adapter
- 1 Audio Left/Right Cable

Notes:

- The DVI port on the TV must support high-bandwidth digital content protection (HDCP).
- When you connect the HDMI connector to the DVI connector on your HDTV, you need an HDMI-to-DVI adapter and a separate audio connection.



WARNING:

Electric shock hazard! Unplug all electronic devices before connecting or disconnecting any device cables to the set-top.

CHS 435HDC

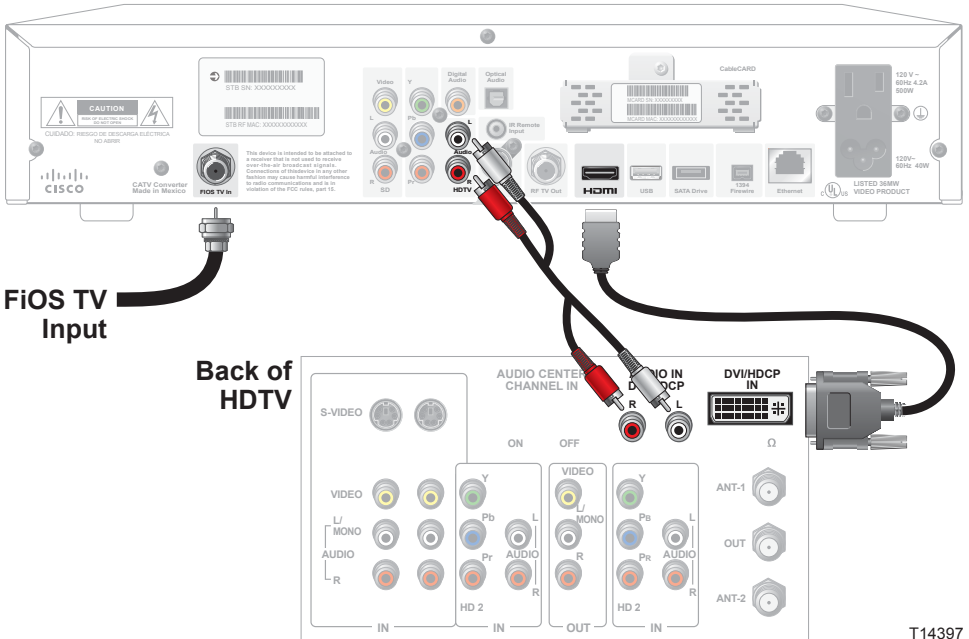

T14397

Connecting to an HDTV with Component (YPbPr) Connectors

Cables Used in this Configuration

- 1 Coaxial Cable
- 1 Component Video Cable (YPbPr)
- 1 Audio Left/Right Cable



WARNING:

Electric shock hazard! Unplug all electronic devices before connecting or disconnecting any device cables to the set-top.

CHS 435HDC

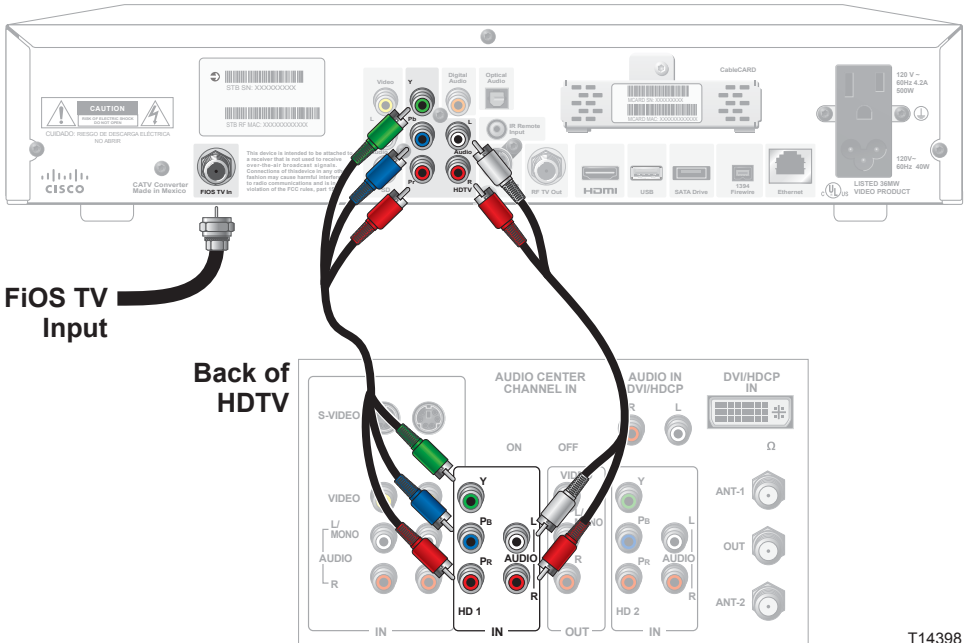

T14398

Connecting to an HDTV with a 1394 Connector

Cables Used in this Configuration

- 1 Coaxial Cable
- 1 Component Video Cable (YPbPr)
- 1 1394 (FireWire) Cable
- 1 Audio Left/Right Cable

Notes:

- This connection requires that audio is provided by the home theater system.
- Consult the user guide that came with your home theatre system for information on connecting your other video and audio devices.



WARNING:

Electric shock hazard! Unplug all electronic devices before connecting or disconnecting any device cables to the set-top.

CHS 435HDC

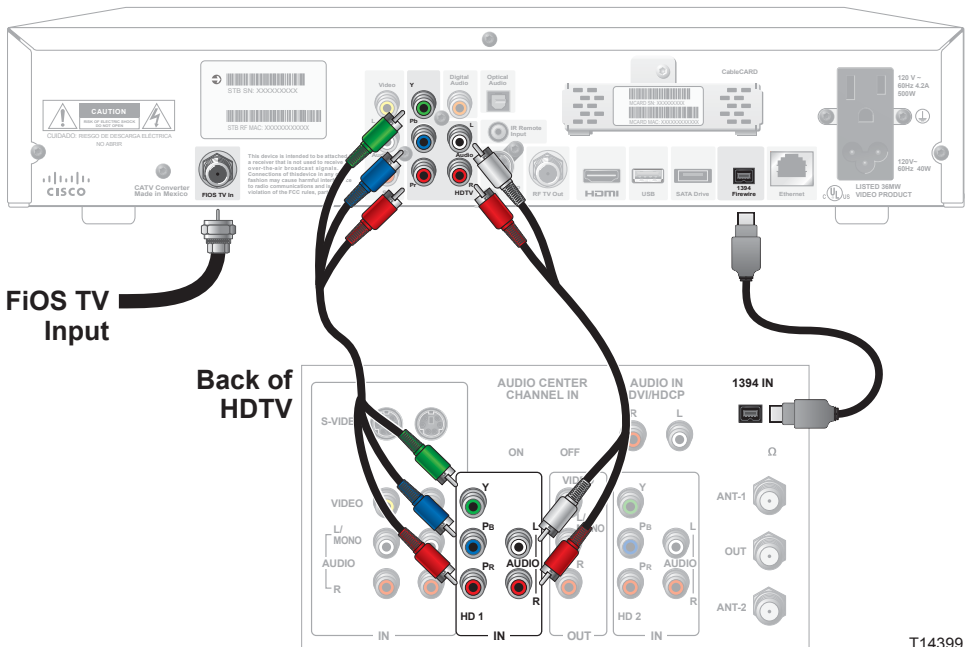

T14399

Connecting to an SDTV with Component (YPbPr) Connectors

Cables Used in this Configuration

- 1 Coaxial Cable
- 1 Component Video Cable (YPbPr)
- 1 Audio Left/Right Cable

Note: The set-top must be set to the proper standard-definition mode.



WARNING:

Electric shock hazard! Unplug all electronic devices before connecting or disconnecting any device cables to the set-top.

CHS 435HDC

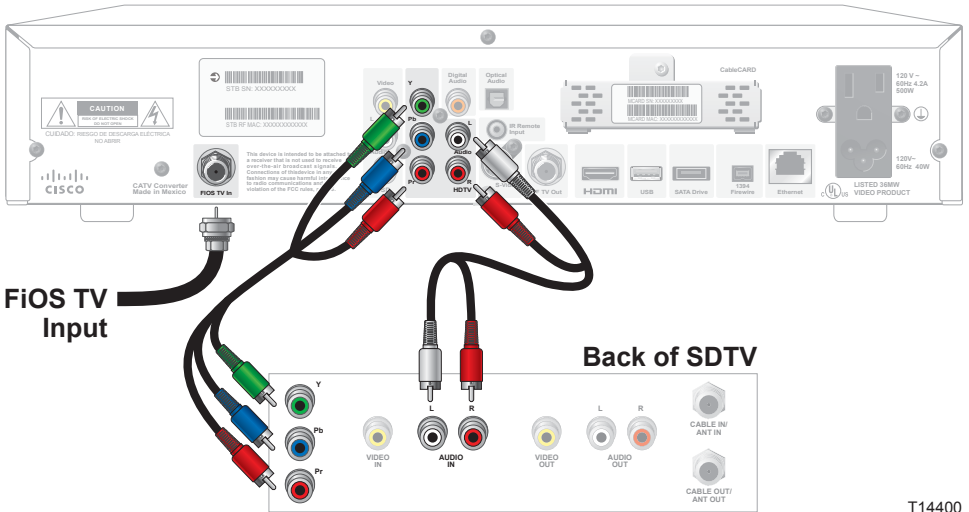

T14400

Connecting to an SDTV with an S-Video Connector

Cables Used in this Configuration

- 1 Coaxial Cable
- 1 S-Video Cable
- 1 Audio Left/Right Cable



WARNING:

Electric shock hazard! Unplug all electronic devices before connecting or disconnecting any device cables to the set-top.

CHS 435HDC

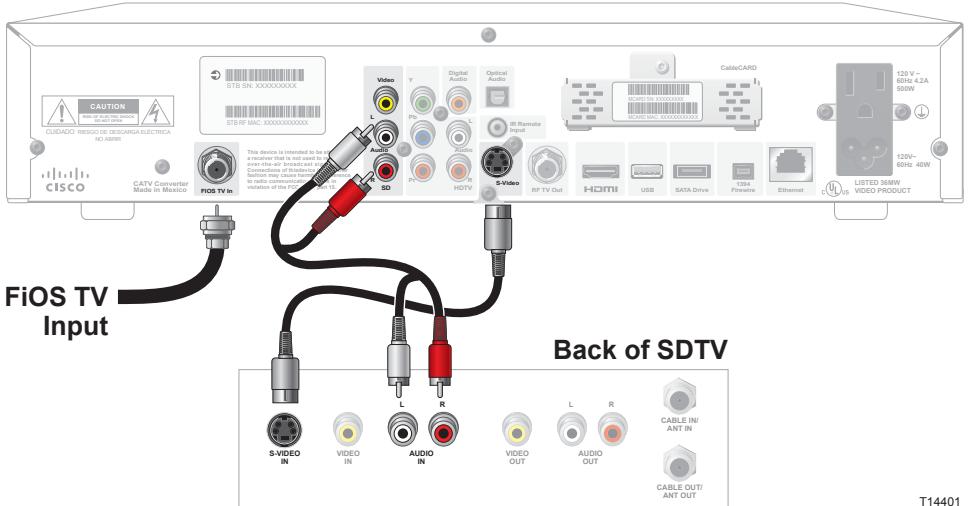

T14401

Connecting to an SDTV with an RCA-Type Connector

Cables Used in this Configuration

- 1 Coaxial Cable
- 1 RCA-type Video Cable
- 1 Audio Left/Right Cable



WARNING:

Electric shock hazard! Unplug all electronic devices before connecting or disconnecting any device cables to the set-top.

CHS 435HDC

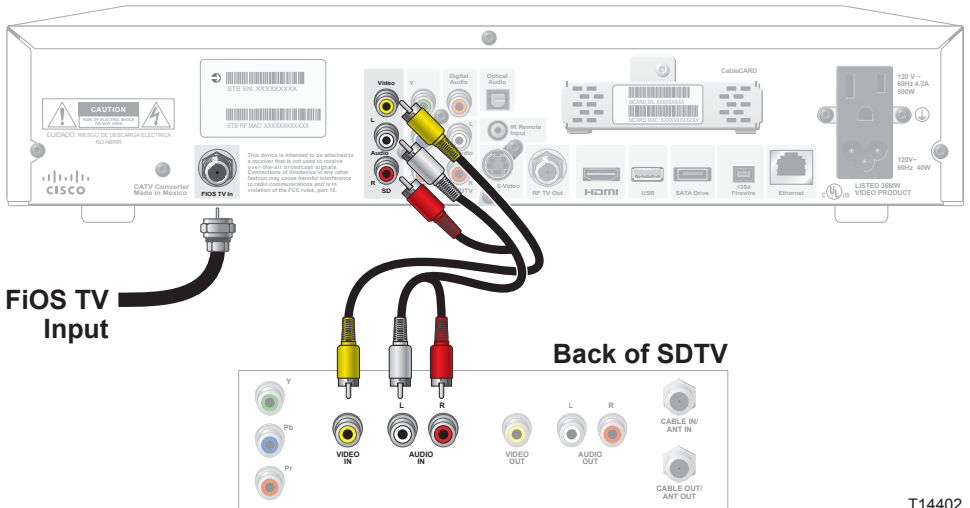

T14402

Connecting to an SDTV with a Coaxial Cable

Cables Used in this Configuration

- 2 Coaxial Cables

Note: You must set the channel on your TV to the channel designated by your service provider (usually channel 3). Contact your service provider for the channel information.



WARNING:

Electric shock hazard! Unplug all electronic devices before connecting or disconnecting any device cables to the set-top.

CHS 435HDC

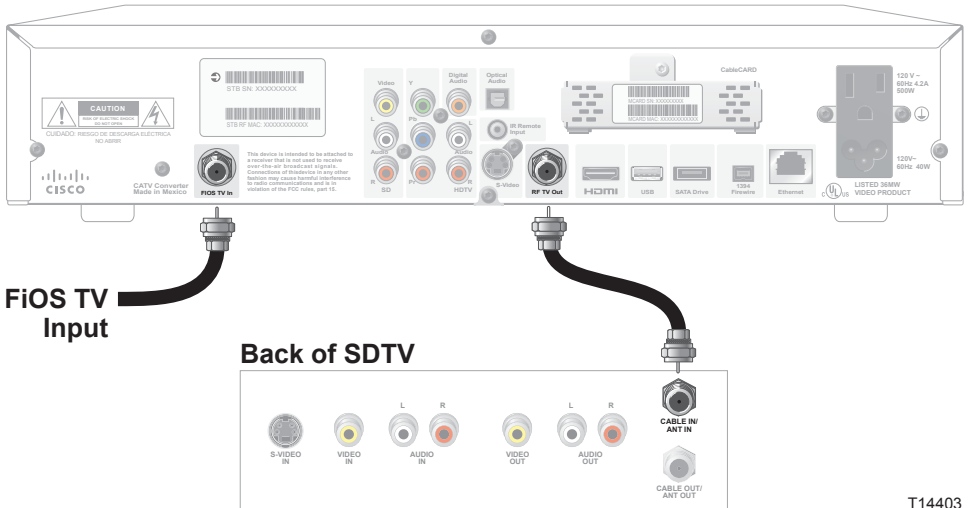

T14403

Connecting to a Home Theater System with Component (YPbPr) Connectors

Cables Used in this Configuration

- 1 Coaxial Cable
- 2 Component Video Cables (YPbPr)
- 1 Audio Left/Right Cable (You can use an optical cable or a digital audio cable [indicated by the dotted lines] instead of the Audio Left/Right Cable as shown in the diagram.)

Notes:

- This connection requires that audio is provided by the home theater system.
- Consult the user guide that came with your home theater system for information on connecting your other video and audio devices.



WARNING:

Electric shock hazard! Unplug all electronic devices before connecting or disconnecting any device cables to the set-top.

CHS 435HDC

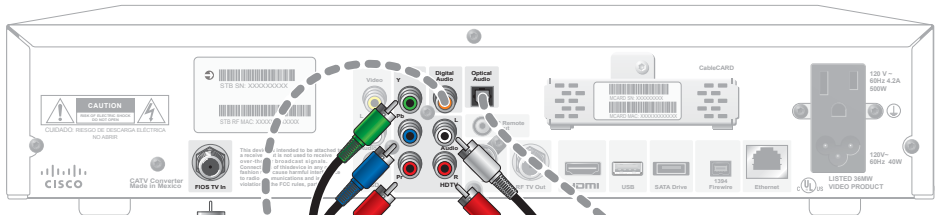

FiOS TV Input

OR

Note: Audio provided by the Home Theater System.

Back of Home Theater Receiver

Note: If your Home Theater System has no component video output ports, connect the component video cables directly from the HDTV to the set-top.

Back of HDTV

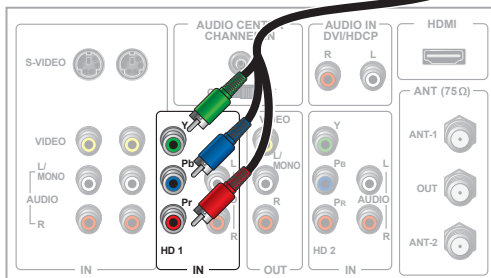
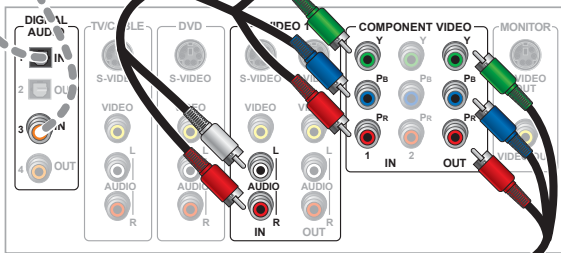

Connecting to a Home Theater System and DVD Player with Component (YPbPr) Connections

Cables Used in this Configuration

- 1 Coaxial Cable
- 3 Component Video Cables (YPbPr)
- 2 Audio Left/Right Cables (You can use optical cables or digital audio cables [indicated by the dotted lines] instead of the Audio Left/Right Cables as shown in the diagram.)

Notes:

- This connection requires that audio is provided by the home theater system.
- Consult the user guide that came with your home theatre system for information on connecting your other video and audio devices.



WARNING:

Electric shock hazard! Unplug all electronic devices before connecting or disconnecting any device cables to the set-top.

CHS 435HDC

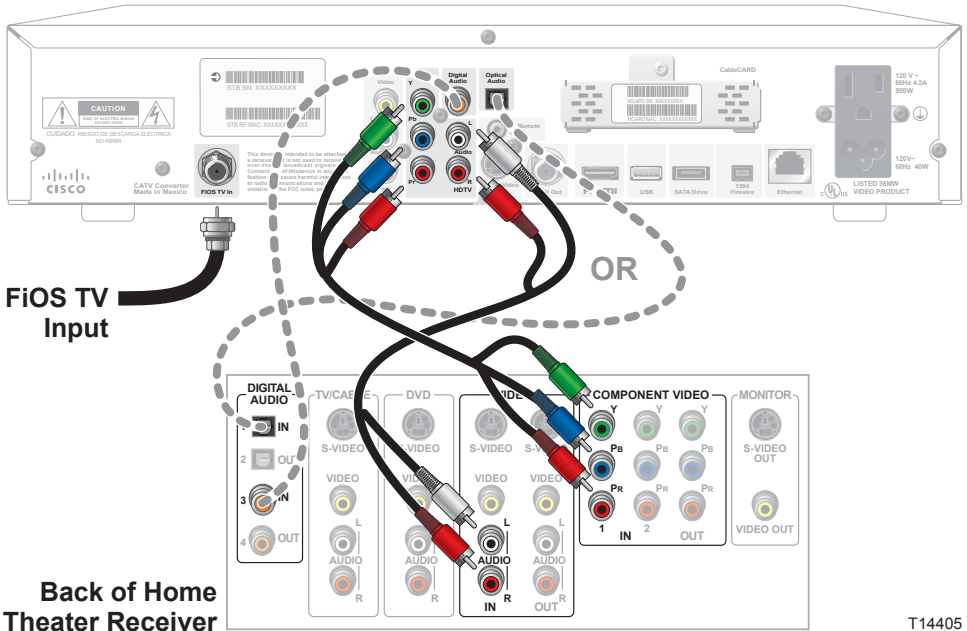

T14405

Connecting to a Home Theater System and DVD Player with Component (YPbPr) Connections, continued



WARNING:

Electric shock hazard! Unplug all electronic devices before connecting or disconnecting any device cables to the set-top.

Back of Home Theater Receiver

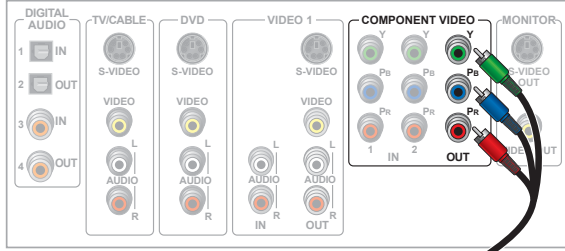

Note: In the HDTV connection diagram, audio is provided by the Home Theater System.

Back of HDTV

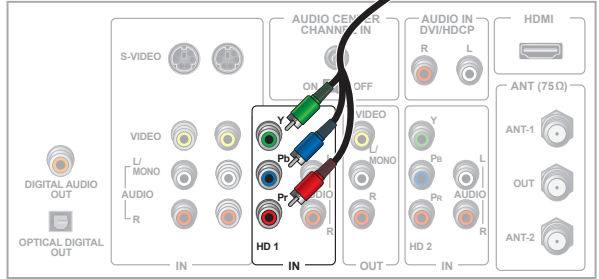

Back of Home Theater Receiver

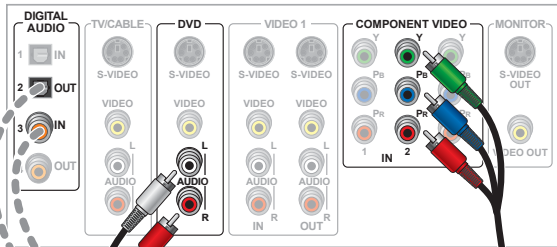

OR

Back of DVD Player

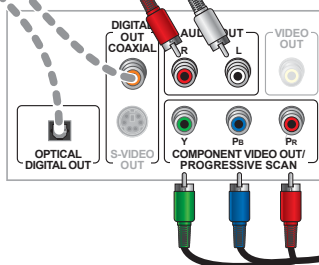

Connecting to a Stereo VCR or DVD Recorder

The diagram below shows how to connect a recording device to your set-top. Although it is possible to watch TV using a connection through your VCR or DVD recorder to the TV, this connection may not provide the best picture, and HDTV users are restricted to an SD format. In addition, some content is copy protected and passing this content through the recording device may result in a picture that cannot be viewed.

For these reasons, the connection shown is best used to provide only video and audio to your recording device and not for normal TV viewing. The connection from the recording device to the TV (only used for playback of recorded material) depends on the type of device being used, the outputs that are supported, and the inputs that remain available for use on your TV.

Consult the user manuals provided with your TV and recording device for more details on connection options.

Cables Used in this Configuration

- 1 Coaxial Cable
- 2 RCA-type Video Cables
- 2 Audio Left/Right Cables



WARNING:

Electric shock hazard! Unplug all electronic devices before connecting or disconnecting any device cables to the set-top.

Connecting your TV directly to the Audio/Video output of your set-top will assure a more vivid picture and enhance your viewing enjoyment.

CHS 435HDC

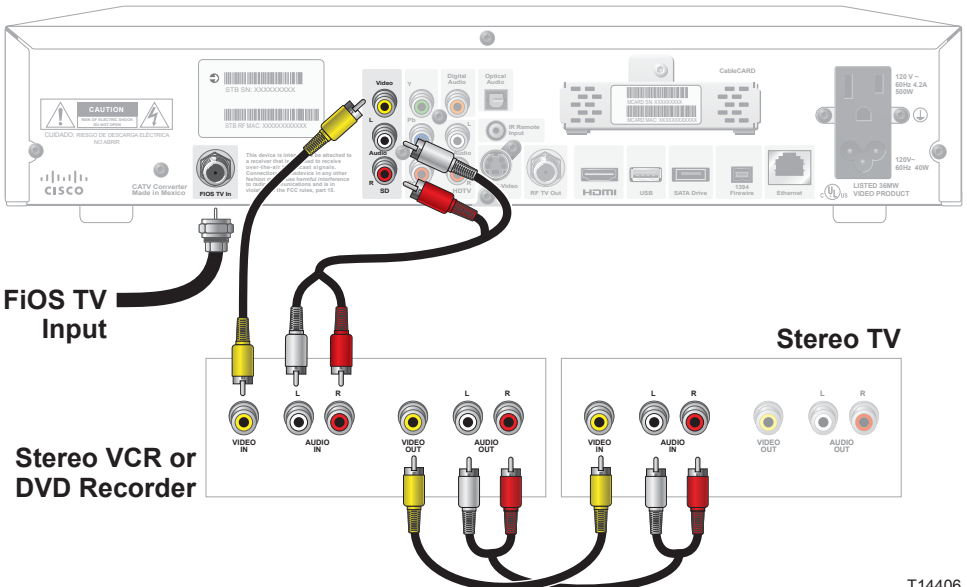

Connecting to an External SATA Hard Disk Drive

An eSATA drive is an extension of the internal hard drive of the DVR; it is not an archival device. Programs recorded to the eSATA drive can be played back on the DVR originally connected to the eSATA drive. For instance, you cannot record programs to the eSATA drive, remove the drive, and then connect it to a computer or a different DVR for playing back programs.

Some programs will record to the DVR internal hard drive and some will record to the eSATA drive, depending on the space available. The DVR selects the drive that has enough space to record the entire program; a program is not split between the internal and external drives.

Cables Used in this Configuration

- 1 Coaxial Cable
- 1 SATA Data Cable
- 1 Power Cable



WARNING:

Electric shock hazard! Unplug all electronic devices before connecting or disconnecting any device cables to the set-top.

CHS 435HDC

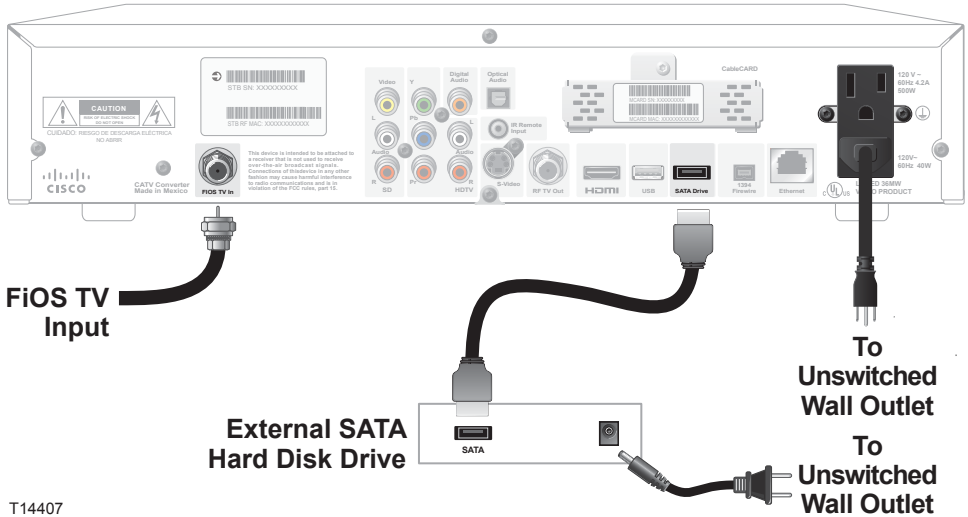

T14407

Connecting to an External SATA Hard Disk Drive, continued

Complete the following steps to install an external SATA (eSATA) drive.

1. Verify that both the DVR and the eSATA drive are unplugged from power.
2. Connect the data cable for the eSATA drive to the DVR.
3. Plug in power to the eSATA drive.
4. Plug in the DVR power cord, and then turn on the DVR.
5. Follow the on-screen instructions. One of the following occurs:
 - If it is a new eSATA drive or one used on another device, you will be asked to format it.
 - If the drive is formatted and will work with this DVR, you will get a confirmation that the drive is working.

Recommendations for the eSATA Drive

Contact your service provider for a list of approved external SATA hard disk drives. At a minimum, your eSATA drive should have the following capabilities:

- External SATA Connector – *SATA II Cable and Connector, Revision 1.0* (Refer to www.sata-io.org for more information)
- Drive Speed – 7200 RPM (5400 RPM without Multi-Room™ DVR); 133 Mbps
- Capacity – Only one eSATA drive can be connected to the DVR. The DVR does not support a separate port multiplier.
- eSATA Drive Power –The eSATA drive should power on when plugged in and should not be controlled by a switch.

Guidelines for Using the eSATA Hard Disk Drive

The eSATA hard disk drive requires continuous power. If the eSATA drive loses power while the DVR is plugged in, the DVR may stop current recordings or not provide enough space for future recordings. Follow these guidelines for using the eSATA drive:

- Do *not* plug in the power cord for the eSATA drive to an outlet controlled by a wall switch or to the AC outlet on the DVR.
- Do *not* turn off, disconnect, or unplug the eSATA drive while the DVR is plugged in.

Disconnecting the eSATA Hard Disk Drive

Complete the following steps to disconnect the eSATA drive safely.

1. Verify that the DVR is powered off.
2. Disconnect the power cord from the DVR and wait for at least 10 seconds.
3. Disconnect the power cord and data cable from the external eSATA drive.

Note: If you improperly disconnect your eSATA drive, you will receive an error message, and you will be required to restart the DVR upon reconnecting.

Troubleshooting

If the set-top does not perform as expected, the following tips may help. If you need further assistance, contact your service provider.

No Picture

- Verify that the power to your TV is turned on.
- If the set-top is plugged into a wall switch, verify that the switch is in the ON position. (Avoid plugging into an outlet that is controlled by a wall switch.)
- Verify that all cables are properly connected.
- If your system includes a VCR, DVD recorder, or stereo, verify that you have properly connected the device to the set-top.
- Verify that you are using the proper input selection to the home theater set-top or TV.
- Verify that the set-top is set to the proper screen type and resolution.
- If you are using coaxial cable to connect to your TV, verify that the TV is tuned to the channel designated by your service provider (usually channel 3). Contact your service provider for the channel information.

No Color or Incorrect Color

- Verify that the current TV program is broadcast in color.
- Adjust the TV color controls.
- If you are using a component video connection (YPbPr), check that all connectors are completely and properly plugged into the set-top and TV.
- If you are using a component video connection (YPbPr) and your HDTV has only RGB or RGB-HV connectors, you must use an adapter. You can obtain the adapter through an electronic parts retailer.

No Sound

- If your setup includes a VCR, DVD recorder, or stereo, verify that you have properly connected the device to the set-top.
- Verify that the volume is turned up.
- Verify that the mute function is not on.
- Verify the proper input selection to the home theater set-top or TV.
- If you are using coaxial cable to connect to your TV, verify that the TV is tuned to the correct channel.

Avoid Screen Burn-In

Images such as letterbox bars or side bars, bright closed-captioning backgrounds, station logos, or any other stationary images may cause the display in your HDTV to age unevenly; this is known as screen burn-in. Refer to the user manual that came with your HDTV for more information.



CAUTION:

Avoid screen burn-in.

Do not display the same fixed images on your HDTV screen for extended periods of time.

Frequently Asked Questions

What Is Digital Television?

Digital television (DTV) is a huge leap forward in television technology compared to analog television that has been widely available since the 1940s. DTV is delivered and displayed using digital encoding, similar to the way a PC operates. By using digital technology, there is no variation in picture and sound quality from the origination point until it is displayed on your television. You always receive a high-quality picture without the wavy lines or static you might sometimes get from a weak analog signal. Another feature of digital television is digital surround sound using Dolby Digital technology, which is the same technology used to produce the sound you hear in movie theaters.

What Is Standard-Definition Television?

Standard-definition television (SDTV) is basic digital television programming delivered by your service provider. Typically, the SDTV screen is the same, nearly square shape as an analog television screen. Digital images on an SDTV set are crisp and clear—noticeably better than on a standard analog television set using an antenna to receive over-the-air signals.

What Is High-Definition Television?

High-definition television (HDTV) is a completely new way to send and receive television broadcast signals. HDTV images are made up of pixels that are much smaller and closer together than those used in standard analog television, and there are millions of them. Thus, HDTV can display five to six times the detail of analog television to deliver picture quality that is much more realistic, dimensional, and precise. SDTV programs can be viewed on an HDTV.

Are Local TV Stations or Other Programmers Broadcasting in HDTV?

Many local TV stations and programmers are transmitting digital signals. However, transmitting a digital signal does not mean transmitting an HDTV signal. Some stations are using the new bandwidth to broadcast several standard-definition channels. Most stations and programmers, once they begin broadcasting in digital, are offering HD content from their parent network (for example, CBS, ABC, NBC, Fox, and PBS). Contact your service provider for more information.

Why Aren't All the Shows I Watch in High-Definition?

A high-definition program must originate in HD format and be broadcast in HD format. Having an HDTV system does not mean that everything you watch will be viewed in high-definition. Getting the signal from a digital source also does not mean it is high-definition.

Why Are Some HDTVs 4:3 Aspect Ratio and Others 16:9?

The aspect ratios differ because television manufacturers build both standard-screen and wide-screen HDTVs to appeal to consumer viewing preferences. The two aspect ratios are as follows:

- On standard-screen (4:3) HDTVs, the programming is displayed in letterbox format in the middle of the screen. There are bars surrounding the picture.
- On wide-screen (16:9) HDTVs, the programming is displayed on the full screen.

What Is HDMI and Does it Support Dolby Digital 5.1 Audio?

The High-Definition Multimedia Interface (HDMI) is an uncompressed, all-digital audio/video interface. The Dolby Digital audio format that provides up to 5.1 separate channels of surround sound, and is the standard used for DVD-Video. HDMI supports standard, enhanced, or high-definition video, plus multi-channel digital audio, such as Dolby Digital audio, on a single cable.

Picture Formats

What Is the Difference Between a Standard-Screen and a Wide-Screen HDTV?

The type of screen your HDTV has (wide-screen or standard-screen) determines how the set-top displays programs on the screen. The picture format for an HDTV is a combination of *aspect ratio* and *screen resolution* and is different for standard-screen and wide-screen HDTVs.

What Is Aspect Ratio?

An aspect ratio is the ratio of the width to the height of the TV screen. The aspect ratios differ because the television industry manufactures both standard-screen and wide-screen HDTVs to appeal to consumer viewing preferences.

What Is the Screen Resolution?

The screen resolution indicates the amount of detail that the picture displays. Resolution is identified by the number of display lines on the screen. The techniques that an HDTV uses to “paint” the picture on the screen are referred to as progressive and interlaced.

With the **progressive scanning** method, the lines are drawn on the screen one at a time in sequential order. Progressive scanning results in a more detailed image on the screen and is also less susceptible to the flicker commonly associated with interlaced scanning. The **interlaced method** involves refreshing pixels in alternation — first the odd lines and then the even lines.

For advanced setup, select the screen resolution that your TV can support. Refer to your HDTV user manuals to choose the proper screen resolution (480i, 720p, 1080i) for your setup.

For example, a screen resolution of 1080i indicates that the screen shows 1080 lines in an interlaced display, and 720p indicates that the screens shows 720 lines in a progressive display.

A **standard-screen HDTV** has a 4x3 aspect ratio. The screen is 4 units wide for every 3 units tall.



A screen resolution of 480i fills the screen.

A **wide-screen HDTV** is one-third wider than a standard-screen HDTV. The screen is 16 units wide for every 9 units tall.



A screen resolution of 720p or 1080i fills the screen.

Index

A

- AC Power input 9
- Aspect ratio 29, 30
- Audio Out 8, 11, 12, 13

B

- Back panel 8
- Burn-in of screen 28
- Buttons See Front Panel

C

- Cables 8, 9, 10, 14-26
- CAT-5 See Ethernet
- Coaxial Cable Input 9, 10, 12, 14-26
- Coaxial network connection 10
- Compliance, FCC 33
- Component video connection. See YPbPr

Connectors

See *also* Front Panel; Back Panel

- 1394 connector 17
- DVD recorder 13, 25
- required for HDTV 11
- required for SDTV 12
- VCR 13

Connecting the set-top to other devices

- 1394 connector 17
- DVD recorder 13, 25
- HDTV with Component input (YPbPr) 16
- HDTV with DVI connector 11, 15
- HDTV with HDMI connector 11, 14
- Home Theater System with Component input (YPbPr) 22
- SDTV with Component input (YPbPr) 18
- SDTV with an S-Video connector 19
- SDTV with an RCA-type connector 20
- SDTV with Coaxial cable 21

- VCR 13, 25

Connection

- Coaxial Network 10
- Consumer electronic devices 9

Controls See Front panel

D

- Diagrams. See Connecting the set-top to other devices
- Digital Video Recorder. See DVR
- Digital TV, What is it 29
- DVD Connection 13, 25
- DVI connector 11, 15
- DVR 7, 8, 26, 27

E

- Ethernet 8, 9, 10

F

- FAQs 29
- FCC compliance 33
- FiOS TV connector 9, 10
- Formats, picture 30
- Frequently Asked Questions. See FAQs
- Front panel 7

H

- Hard disk drive, Caution 7
- HD
 - format 29
 - HDTV broadcasting 29
 - HDTV, what is it 29
 - indicator 7
- HDMI 8, 11, 14, 15, 29
- High-definition See HD
- Home theater system connection 22-24

Index, continued

I

Interlaced screen resolution 30

IR sensor 7

K

Keys. See Front panel

M

M-Card 8

N

Network 9, 10

O

Optical Audio Output 8, 11, 22, 23, 24

Over-the-air converter box 13

P

Picture formats 30

Ports. See Connectors

Power 6, 7, 8

R

Record programs 9, 26

RF TV connector 8, 12, 21

RGB connector 11, 28

S

S-Video 8, 12, 13, 19

Safety 4, 5

Scan rates. See screen resolution

Screen

burn-in 28

resolution 30

size 30

SD

Connections 12, 18, 19, 20, 21

TV, What is it 29

Serial number, locating 6

Sound, performance 28

Standard-definition TV 12, 18, 19, 20, 21, 29

Standard-screen TV 30

T

Troubleshooting 28

TV

digital, what is it 29

formats 30

HDTV, what is it 29

programming 29

recording 9, 26

resolution 30

screen size. See aspect ratio

standard-screen 30

standard-definition 12, 18, 19, 20, 21, 29

wide-screen 30

U

USB port 7, 8

V

VCR connection 9, 13, 25

W

Wide-screen TV 30

Y

YPbPr

connector 8, 11, 12, 16, 17, 18, 22, 23, 24

HDTV connection 11, 18

home theater connection 22

SDTV connection 12, 18

United States FCC Compliance

This device has been tested and found to comply with the limits for a Class B digital device, pursuant to part 15 of the FCC Rules. These limits are designed to provide reasonable protection against such interference in a residential installation. This equipment generates, uses, and can radiate radio frequency energy. If not installed and used in accordance with the instructions, it may cause harmful interference to radio communications. However, there is no guarantee that interference will not occur in a particular installation. If this equipment does cause harmful interference to radio or television reception, which can be determined by turning the equipment OFF and ON, the user is encouraged to try to correct the interference by one or more of the following measures:

- Reorient or relocate the receiving antenna.
- Increase the separation between the equipment and receiver.
- Connect the equipment into an outlet on a circuit different from that to which the receiver is connected.
- Consult the service provider or an experienced radio/television technician for help.

Any changes or modifications not expressly approved by Cisco Systems, Inc., could void the user's authority to operate the equipment.

The information shown in the FCC Declaration of Conformity paragraph below is a requirement of the FCC and is intended to supply you with information regarding the FCC approval of this device. *The phone numbers listed are for FCC-related questions only and not intended for questions regarding the connection or operation for this device. Please contact your service provider for any questions you may have regarding the operation or installation of this device.*

Declaration of Conformity

This device complies with Part 15 of FCC Rules.

Operation is subject to the following two conditions:

- 1) the device may not cause harmful interference, and
- 2) the device must accept any interference received, including interference that may cause undesired operation.

<p>Cisco CHS 435HDC High-Definition Set-Top Model: CHS 435HDC Manufactured by: Cisco Systems, Inc. 5030 Sugarloaf Parkway Lawrenceville, Georgia 30044 USA Telephone: 770-236-1077</p>
--

Canada EMI Regulation

This Class B digital apparatus complies with Canadian ICES-003.

Cet appareil numérique de la class B est conforme à la norme NMB-003 du Canada.

20081121 FCC Standard

AVC VIDEO LICENSE

With respect to each AVC/H.264 product, we are obligated to provide the following notice:

THIS PRODUCT IS LICENSED UNDER THE AVC PATENT PORTFOLIO LICENSE FOR THE PERSONAL AND NON-COMMERCIAL USE OF A CONSUMER TO (i) ENCODE VIDEO IN COMPLIANCE WITH THE AVC STANDARD ("AVC VIDEO") AND/OR (ii) DECODE AVC VIDEO THAT WAS ENCODED BY A CONSUMER ENGAGED IN A PERSONAL AND NON-COMMERCIAL ACTIVITY AND/OR WAS OBTAINED FROM A VIDEO PROVIDER LICENSED TO PROVIDE AVC VIDEO. NO LICENSE IS GRANTED OR SHALL BE IMPLIED FOR ANY OTHER USE. ADDITIONAL INFORMATION MAY BE OBTAINED FROM MPEG LA, L.L.C. SEE [HTTP://WWW.MPEGLA.COM](http://WWW.MPEGLA.COM).

Accordingly, please be advised that service providers, content providers, and broadcasters are required to obtain a separate use license from MPEG LA prior to any use of AVC/H.264 encoders and/or decoders.

MACROVISION COPYRIGHT NOTICE

This product incorporates copyright protection technology that is protected by U.S. patents and other intellectual property rights. Use of this copyright protection technology must be authorized by Macrovision, and is intended for home and other limited viewing uses only unless otherwise authorized by Macrovision. Reverse engineering or disassembly is prohibited.

Disclaimer

Cisco Systems, Inc. assumes no responsibility for errors or omissions that may appear in this guide. We reserve the right to change this guide at any time without notice.



Cisco Systems, Inc.
5030 Sugarloaf Parkway, Box 465447
Lawrenceville, GA 30042

678.277.1000

www.cisco.com

Cisco, Cisco Systems, the Cisco logo, and the Cisco Systems logo are registered trademarks or trademarks of Cisco Systems, Inc. and/or its affiliates in the U.S. and certain other countries.

CableCARD and M-Card are trademarks of Cable Television Laboratories, Inc.

Manufactured under license from Dolby Laboratories. Dolby is a trademark of Dolby Laboratories.

HDMI, the HDMI logo, and High-Definition Multimedia Interface are trademarks or registered trademarks of HDMI Licensing LLC.

Macrovision is a registered trademark of Macrovision Corp.

MoCA is a trademark of the Multimedia over Coax Alliance.

All other trademarks mentioned in this document are the property of their respective owners.

Product and service availability is subject to change without notice.

© 2009 Cisco Systems, Inc. All rights reserved.