



Verizon  
Router  
**USER  
GUIDE**



# CONTENTS

---

## 01/

### INTRODUCTION

- 1.0 Package Contents 6
- 1.1 System Requirements 6
- 1.2 Features 6
- 1.3 Getting to Know Your Verizon Router 9

## 02/

### CONNECTING YOUR VERIZON ROUTER

- 2.0 Setting up Your Verizon Router 21
- 2.1 Expanding Wi-Fi Coverage 29
- 2.2 Computer Network Configuration 32
- 2.3 Main Screen 39

## 03/

### WI-FI SETTINGS

- 3.0 Overview 45
- 3.1 Basic Settings 46
- 3.2 Advanced Settings 56

## 04/

### CONNECTED DEVICES

- 4.0 Overview 64
- 4.1 Device Settings 64

## 05/

### SETTING PARENTAL CONTROLS

- 5.0 Activating Parental Controls 70
- 5.1 Active Rules 73

## 06/

### CONFIGURING ADVANCED SETTINGS

6.0	Firewall	78
6.1	Utilities	93
6.2	Network Settings	107
6.3	Date & Time	159
6.4	DNS Settings	162
6.5	Monitoring	166
6.6	System Settings	170

## 07/

### TROUBLESHOOTING

7.0	Troubleshooting Tips	176
7.1	Frequently Asked Questions	182

## 08/

### SPECIFICATIONS

8.0	General Specifications	189
8.1	LED Indicators	190
8.2	Environmental Parameters	191

## 09/

### NOTICES

9.0	Regulatory Compliance Notices	195
-----	-------------------------------	-----

---

# 01 /

# INTRODUCTION

- 1.0** Package Contents
- 1.1** System Requirements
- 1.2** Features
- 1.3** Getting to Know Your Verizon Router

---

Verizon Router lets you transmit and distribute digital entertainment and information to multiple devices in your home/office.

Your Verizon Router supports networking using coaxial cables, Ethernet, or Wi-Fi, making it one of the most versatile and powerful routers available.

# PACKAGE CONTENTS, SYSTEM REQUIREMENTS AND FEATURES

---

## 1.0/ PACKAGE CONTENTS

*Your package contains:*

- Verizon Router
- Power adapter
- Ethernet cable, three meters (white)

## 1.1/ SYSTEM REQUIREMENTS

*System and software requirements are:*

- A computer or other network device supporting Wi-Fi or wired Ethernet
- A web browser, such as Chrome™, Firefox®, Internet Explorer 8® or higher, or Safari® 5.1 or higher

## 1.2/ FEATURES

*Your Verizon Router features include:*

- Support for multiple networking standards, including
  - WAN – 10 Gigabit Ethernet
  - LAN – 802.11 a/b/g/n/ac/ax, 10/2.5 Gigabit Ethernet and MoCA 2.5 interfaces
- Integrated wired networking with 3-port Ethernet switch and Coax (MoCA)
  - Ethernet supports speeds up to 10 Gbps

- 
- MoCA 2.5 LAN enabled to support speeds up to 2500 Mbps over coaxial cable
  - One Type-C USB 3.0 port
  - Integrated Wi-Fi networking with 802.11a/b/g/n/ac/ax access point featuring:
    - backward compatible to 802.11a/b/g/n/ac
    - 2.4 GHz 11ax 4x4
    - 5 GHz 11ax 4x4
    - 6 GHz 11ax 4x4
  - Enterprise-level security, including:
    - Fully customizable firewall with Stateful Packet Inspection (SPI)
    - Content filtering with URL-keyword based filtering, parental controls, and customizable filtering policies per computer
    - Intrusion detection with Denial of Service protection against IP spoofing attacks, scanning attacks, IP fragment overlap exploit, ping of death, and fragmentation attacks
    - Virtual server functionality; providing protected access to internet services such as web, FTP, email, and telnet
    - DMZ (demilitarized zone) host support of a network security neutral zone between a private network and the internet
    - Event logging
    - Home Network Protection
    - SIP ALG

# FEATURES

---

- Static NAT
- Port forwarding
- Port triggering
- Access control
- Advanced Wi-Fi protection featuring WPA2 & WPA3 Modes and MAC address filtering
- Wi-Fi Multimedia (WMM) for Wi-Fi QoS (quality-of-service)
- Dual-stack network configuration of IPv4 and IPv6
- DHCP server
- WAN interface auto-detection
- Dynamic DNS
- DNS server
- LAN IP and WAN IP address selection
- MAC address cloning
- QoS support (end to end layer 2/3) featuring: Differentiated Services (Diffserv), 802.1p/q prioritization, and pass-through of WAN-side DSCPs, Per Hop Behaviors (PHBs), and queuing to LAN-side devices
- Secure remote management using HTTPS or Verizon app
- Static routing
- VPN (VPN pass through only)
- IGMP
- Daylight savings time support



## 1.3/ GETTING TO KNOW YOUR VERIZON ROUTER

### 1.3a/ FRONT PANEL

The Router Status LED will be solid white when your Verizon Router is turned on, connected to the internet, and functioning normally.

*Front  
Panel  
router  
status  
LED*

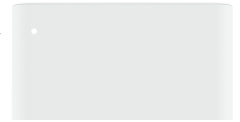

#### *Router Status LED*

Condition Status	LED Color	Verizon Router
Normal	WHITE	Normal operation (solid) Router is booting (fast blink) System restart (fast blink)
	BLUE	Pairing mode (slow blink) WPS pairing successful (fast blink)
	GREEN	Wi-Fi has been turned off (solid)
Issue(s)	YELLOW	No internet connection (solid)
	RED	Hardware/System failure detected (slow blink) Overheating (fast blink) System update error (fast blink) WPS pairing failure (fast blink)
Power	OFF	Power off

# GETTING TO KNOW YOUR VERIZON ROUTER

## 1.3b/ REAR PANEL

The rear panel of your router has a label that contains important information about your device, including the default settings for the Verizon Router's Wi-Fi name (SSID), Wi-Fi password (WPA2 key), local URL for accessing the router's network settings, and network settings password. The label also contains a QR code that you can scan with your smartphone, tablet, or other camera-equipped Wi-Fi device to allow you to automatically connect your device to your Wi-Fi network without typing in a password (requires a QR code reading app with support for Wi-Fi QR codes).

**Wi-Fi Name:** Verizon\_HHYN49  
**Wi-Fi Password:** uptown-woo7-web  
**Network Settings URL:** mynetworksettings.com  
**Network Settings Password:** P9K9DSZ7V  
**Support URL:** support.verizon.com/router



The rear panel has six ports; F-type coax, Ethernet LAN (three), Ethernet WAN, and USB. The rear panel also includes a DC power jack and a reset button.

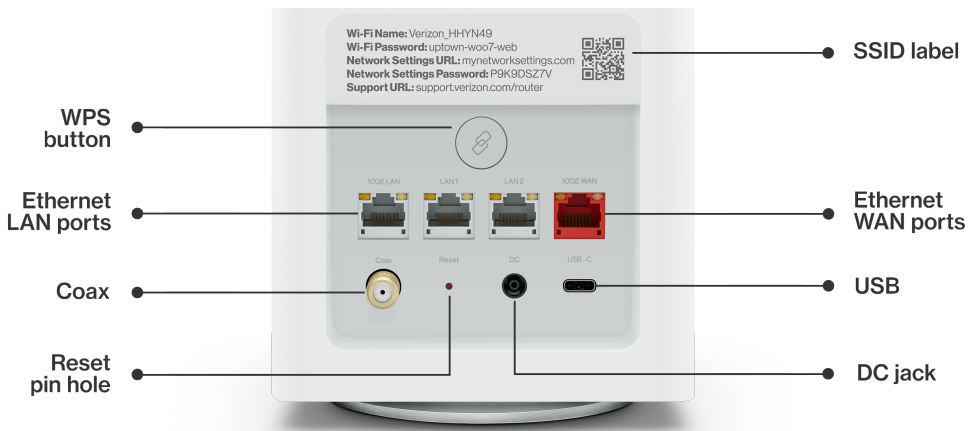

- **WPS Button** - allows quick access to the Wi-Fi Protected Setup (WPS) feature and pairing mode.

The WPS button is used to initiate Wi-Fi Protected Setup. This is an easy way to add WPS capable devices to your Wi-Fi network. To activate the WPS function, press and hold the WPS button located on the rear of your Verizon Router for more than two seconds. When WPS is initiated from your router, the Router Status LED slowly flashes blue for up to two minutes, allowing time to complete the WPS pairing process on your Wi-Fi device (also known as a Wi-Fi client). When a device begins connecting to your router using WPS, the Router Status LED rapidly flashes blue for a few seconds, and then solid white as the connection completes.

If there is an error during the WPS pairing process, the Router Status LED rapidly flashes red for two minutes after the error occurs.

Refer to the “Connecting A Wi-Fi Device Using WPS” on page 35 for more details. In addition, the Router Status LED also provides a quick view of the operational state of the Verizon Router using various colors as indicated in the chart above.

- **Ethernet LAN** - connects devices to your Verizon Router using Ethernet cables to join the local area network (LAN). The three Ethernet LAN ports:
  - one 10GE LAN port is 100 Mbps, 1/2.5/5/10 Gbps auto-sensing
  - the other two 2.5GE LAN ports are 10/100 Mbps, 1/2.5 Gbps auto-sensing

# GETTING TO KNOW YOUR VERIZON ROUTER

---

- **Type-C USB** - provides up to 1000 mA at 5 VDC for attached devices. For example, you could charge a cell phone.
- **10Gbps Ethernet WAN** - connects your Verizon Router to the internet using an Ethernet cable.
- **Coax LAN** - connects your router to other MoCA devices using a coaxial cable.

***Warning:** The coax port is intended for connection to Verizon devices only. It must not be connected to any exterior or interior coaxial wires not designated for Verizon devices.*

- **Reset Button** - allows you to reset your router to the factory default settings. To perform a soft reboot, press and hold the button for at least three seconds. To reset your router to the factory default settings, press and hold the button for at least ten seconds.
- **Power** - connects your Verizon Router to an electrical wall outlet using the supplied power adapter.

***Warning:** The included power adapter is for home use only, supporting voltages from 105-125 voltage in AC. Do not use in environments with greater than 125 voltage in AC.*

## **1.3c/ REAR LIGHTED INDICATORS**

### **LAN/WAN Ethernet**

- Unlit – Indicates no Ethernet link or dims after 5 minutes idle

### **Left LED**

- Solid yellow – Indicates 1 Gbps link
- Flash yellow – Indicates LAN/WAN activity. The traffic can be in either direction.

### **Right LED**

- Solid white – Indicates 2.5/10 Gbps link
- Flash white – Indicates LAN/WAN activity. The traffic can be in either direction.

## **1.3d/ MOUNTING THE VERIZON ROUTER TO A WALL**

For optimum performance, the Verizon Router is designed to stand in a vertical upright position. Verizon does not recommend wall mounting the Verizon Router. However, if you wish to mount your Verizon Router, you can purchase a wall mount bracket from the Verizon Accessories Store at [verizon.com/home/accessories/networking-wifi](https://www.verizon.com/home/accessories/networking-wifi)

To mount your Verizon Router to a wall:

1. Select a mounting spot near a power outlet and the Ethernet port of the device that provides internet on your premises.

# GETTING TO KNOW YOUR VERIZON ROUTER

---

2. Mark screw hole positions on the wall. Drill holes for the wall anchors using a 1/4 inch (6.35 mm) drill bit.
3. Insert the anchors in the drilled holes and hammer until they are flush with the wall.

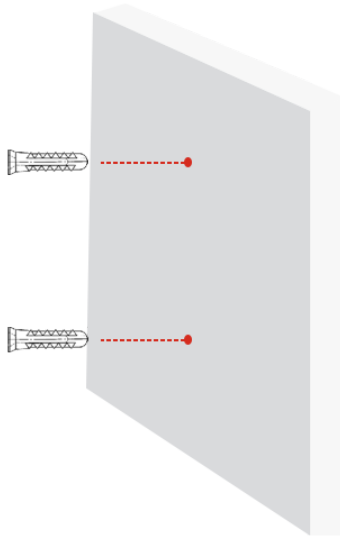

4. Place the screws into the small holes of the bracket and tighten the screws into your wall for securing the wall mount bracket.

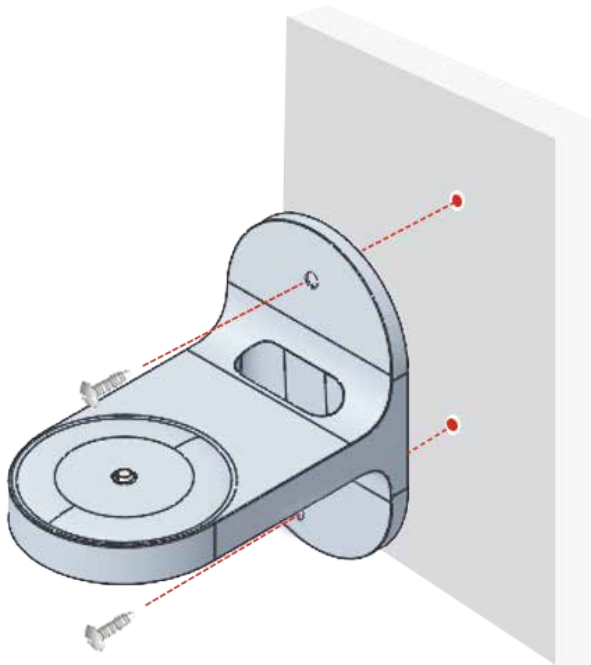

# GETTING TO KNOW YOUR VERIZON ROUTER

---

5. Align the mounting hole located on the bottom of the router to the screw of the wall mount bracket.

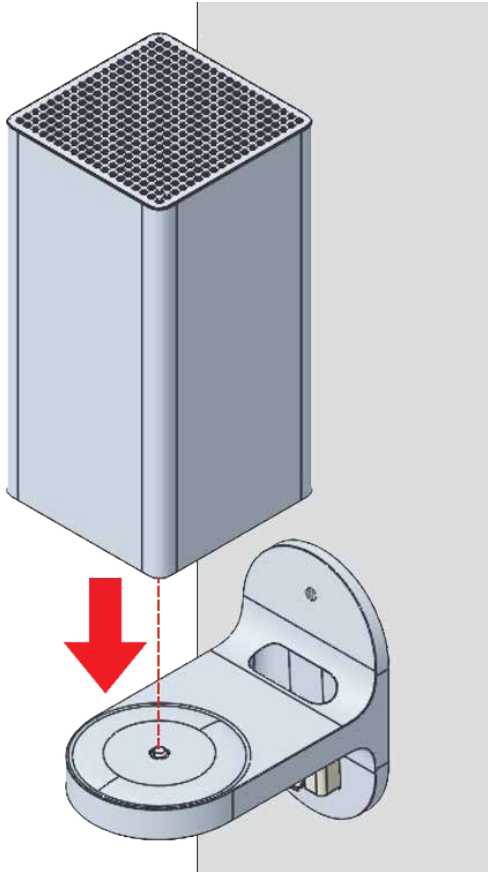



6. Rotate and align the router to the preferred position. While using the hole in the mounting bracket, connect the Ethernet cable providing internet to the router's WAN port and other cables as needed. Tighten the bracket screw to lock the device in place.

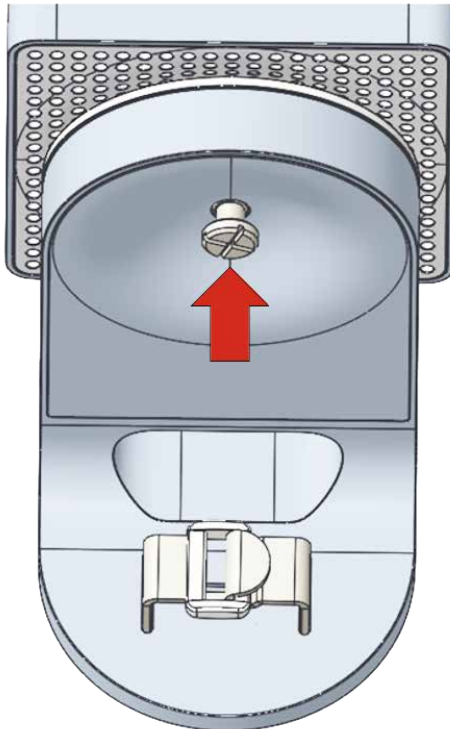

# GETTING TO KNOW YOUR VERIZON ROUTER

---

7. To fasten the attached cables of the router, manage the cables, then tighten the Velcro® strap with buckle.

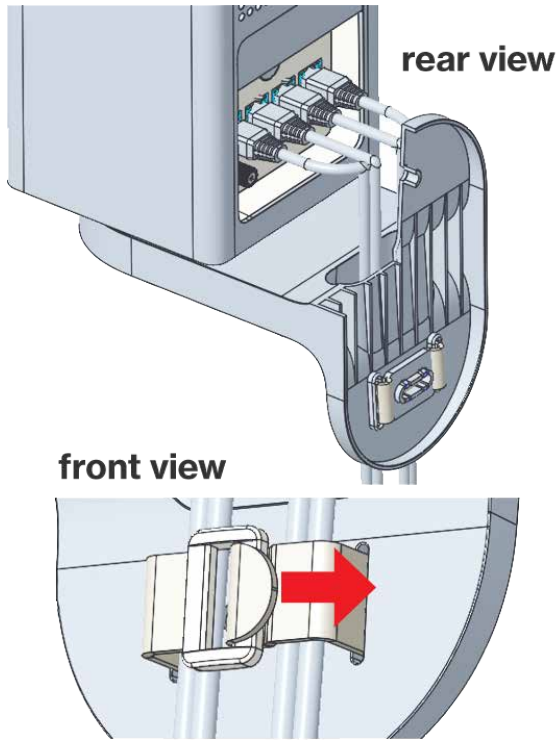

---

02 /

# CONNECTING YOUR VERIZON ROUTER

- 2.0** Setting up Your Verizon Router
- 2.1** Expanding Wi-Fi Coverage
- 2.2** Computer Network Configuration
- 2.3** Main Screen

Connecting your Verizon Router and accessing its web-based User Interface (UI) are both simple procedures.

Accessing the UI may vary slightly, depending on your device's operating system and web browser.

# SETTING UP YOUR VERIZON ROUTER

---

## 2.0/ SETTING UP YOUR VERIZON ROUTER

Before you begin, if you are replacing an existing router, disconnect it. Remove all old router components, including the power supply. They will not work with your new Verizon Router.

### 2.0a/ INSTALLATION INSTRUCTIONS

#### 1. CONNECT YOUR CABLES

- A. Connect the coax cable from the coax port on your router to a coax outlet. (Required for Fios TV; skip for 5G Home installation)
  - Separate subscription required for Fios TV; not available in all areas.
- B. Connect the Ethernet cable from your router's WAN port to an Ethernet outlet. (Required for internet speeds greater than 100 Mbps)
- C. Connect the power cord to your router then to an electrical outlet.

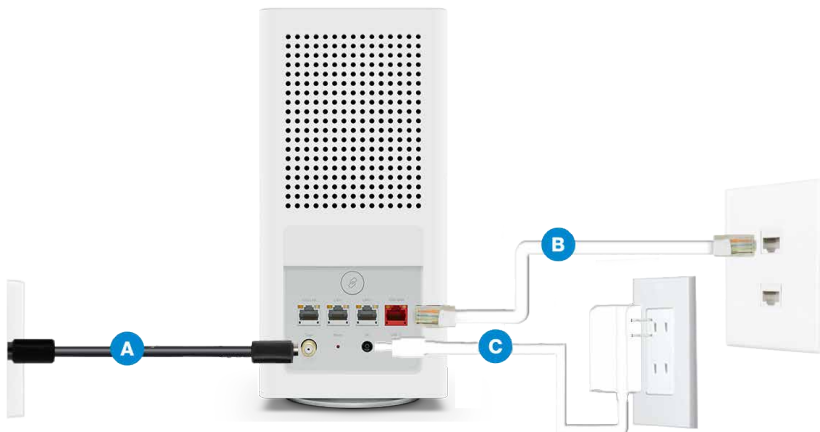

- D. Router will take up to 10 minutes to update completely. Move on when the front light is solid white.

## 2. CONNECT YOUR DEVICES

Wired or Wi-Fi? Your choice.

### Wired

- A. Connect the Ethernet cable to any LAN port on your router.
- B. Connect the other end to your computer.

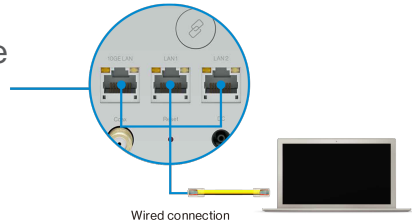

### Wi-Fi

- A. Get the Wi-Fi name and password off the label on your router.
- B. On your device, choose your Wi-Fi name when it appears.
- C. Enter the Wi-Fi password exactly as it is on your router label.



Router label

# SETTING UP YOUR VERIZON ROUTER

---

## Wi-Fi Network

The Verizon Router has one Wi-Fi name supporting 2.4 and 5 GHz signals. 6 GHz can be enabled and included as well with heightened security, WPA3. The Self-Organizing Network (SON) feature lets your devices move between these signals automatically for an optimized Wi-Fi connection.

### 3. COMPLETE ACTIVATION

Activate your service by opening a web browser on your computer and following the prompts. (Skip for 5G Home installation)

## 2.0b/ CONFIGURE YOUR VERIZON ROUTER

1. Open a web browser on the device connected to your Verizon Router network.
2. In the browser address field (URL), enter: [mynetworksettings.com](https://mynetworksettings.com), then press the **Enter** key on your keyboard.

Alternately, you can enter: <https://192.168.1.1>

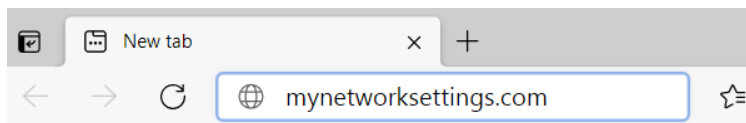

3. You may see a security message warning that **Your connection is not private** when you visit [mynetworksettings.com](https://192.168.1.1) (<https://192.168.1.1>) for GUI management. To get to the login screen, click the **ADVANCED** button, then on **Proceed to 192.168.1.1 (unsafe)** link.

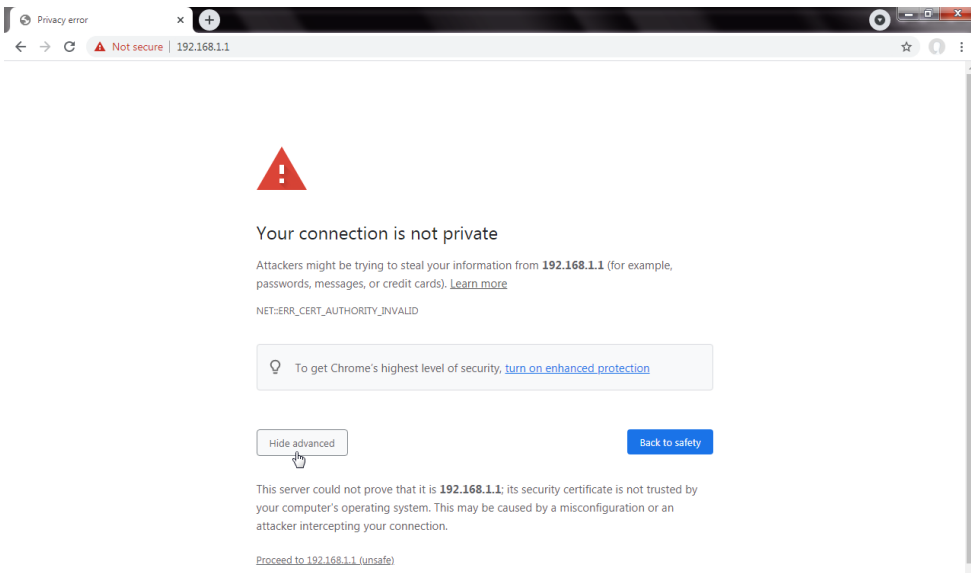

4. The login screen will appear.  
The first time you access your Verizon Router, an Easy Setup Wizard displays to help step you through the setup process.
5. On the **Step 1: Please log in to your router** screen, enter the password that is printed next to the Network Settings Password on the label on the rear of your router. Click **Continue**.



# SETTING UP YOUR VERIZON ROUTER

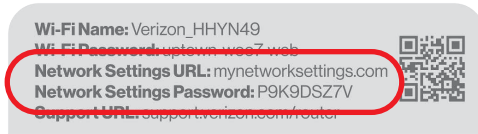
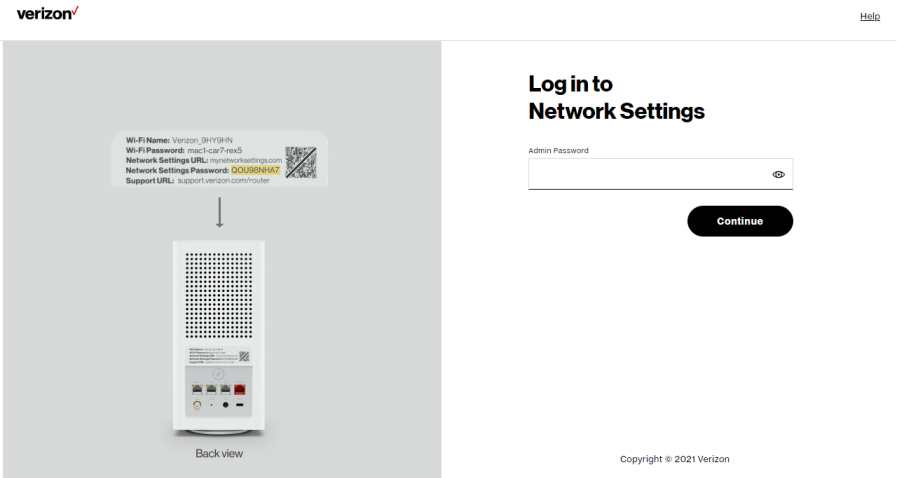

6. The **Change Wi-Fi name** screen displays. You can continue with the default settings or customize them as needed. For your protection, your Verizon Router is pre-set at the factory to use WPA2 (Wi-Fi Protected Access II) encryption for your Wi-Fi network. This is the best setting for most users and allows the most devices to securely connect.
7. You can optionally set up the **Guest Wi-Fi** network by toggling the selection to **On**. You can continue with the default settings or customize them as needed.

- 
8. You can optionally enable the **6 GHz Wi-Fi** band by toggling the selection to **On**. Review the notification that enabling 6 GHz will modify the existing 2.4 & 5 GHz security from WPA2 to WPA2/WPA3 and 6 GHz will be enabled using WPA3. You can continue to use one Wi-Fi Name and Password across all Wi-Fi bands.

The IoT Wi-Fi will also be enabled for any devices that do not support WPA3, and this will use a unique Wi-Fi name and password based on the default SSID & Password. Devices on this Wi-Fi will be able to communicate with other devices on the Primary network with no firewall restrictions separating them.

9. Click **Continue** to review your settings.
10. The **Apply Wi-Fi changes** screen is displayed. Review your current settings. You may optionally save your settings as an image on your device by selecting the button, **Save as Image**. Click **Apply** to save the Wi-Fi changes to your Verizon Router.

# SETTING UP YOUR VERIZON ROUTER

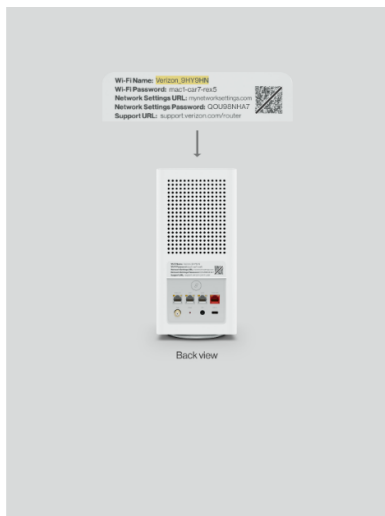

## Change Wi-Fi name

Wi-Fi Name  
Verizon\_4G4YOT

Wi-Fi Password  
\*\*\*\*\*

**Guest Wi-Fi** Enabled

Guest Wi-Fi Name  
Verizon\_4G4YOT-Guest

Guest Wi-Fi Password  
Enter new password

Minimum 8 characters

**6 GHz Wi-Fi** Enabled

[Back](#) [continue](#)

Copyright © 2021 Verizon

For your protection, your Verizon Router is pre-set at the factory to use WPA2 (Wi-Fi Protected Access II) encryption for your Wi-Fi network. This is the best setting for most users and provides security.

11. Click **Continue**. The **Apply Wi-Fi changes** screen appears. You have an option of saving the Wi-Fi settings as an image on your device by clicking the **Save as image** button. After you click **Save as image** to save your Wi-Fi settings as an image, click **Apply** to save the Wi-Fi changes to your Verizon Router.

**Note:** If you select **Save as image**, the image file is saved to your web browser's download folder.

**Important:** If you are on a Wi-Fi device when setting up your Verizon Router and changes are made to the Wi-Fi name or password, then you will be disconnected from the Wi-Fi network. When this occurs, review the Wi-Fi networks available and choose the network name when it appears. Enter the Wi-Fi password you have applied, and your device will reconnect to the Verizon Router.

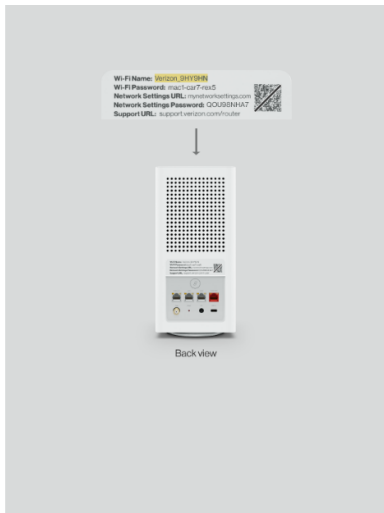

### Apply Wi-Fi changes

Wi-Fi Info Save as image

---

Wi-Fi Name  
**Verizon\_4G4YOT**

---

Wi-Fi Password  
**egg5-vanish-one**

---

Security  
**WPA2/WPA3 (2.4 & 5 GHz)**  
**WPA3 (6 GHz)**

---

Guest Wi-Fi ON

---

Guest Wi-Fi Name  
**Verizon\_4G4YOT-Guest**

---

Guest Wi-Fi Password  
**123456789**

---

[Back](#) Apply

Copyright © 2021 Verizon

# EXPANDING WI-FI COVERAGE

---

The **You're all set up!** screen displays once your Verizon Router verifies the final settings and has successfully connected to the internet and is ready for use. You can click on **Go to Network Settings** to access the main screen of the Verizon Router.



**You're all set up!**

[Go to Network Settings](#)

If your Verizon Router is subsequently reset to the factory default settings, the settings printed on the label will again be in effect.

If your Verizon Router fails to connect, follow the troubleshooting steps in the Troubleshooting section of this guide.

## **2.1/ EXPANDING WI-FI COVERAGE**

Connecting one or more of Verizon's Wi-Fi Extender Minis or Fios Extenders to the Verizon Router allows you to extend the Verizon Router's Wi-Fi signal range and to eliminate Wi-Fi dead zones on your Wi-Fi network.

## 2.1a/ Wi-Fi Installation with Wi-Fi Extender Mini

1. Plug the Wi-Fi Extender Mini into a power outlet next to the Verizon Router.



2. When the light on front is solid yellow, press the  pair button on the Verizon Router and the Extender Mini. Both devices will blink blue while pairing.

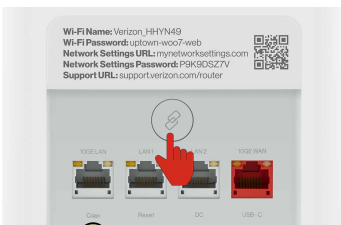

Front  
Panel  
Status  
LED



3. Wait until you see a blinking yellow light then unplug the Wi-Fi Extender Mini.

# EXPANDING WI-FI COVERAGE

---

4. Move it to an area between the router and the weak Wi-Fi coverage, then plug it in.

*Note: When plugging in the Wi-Fi Extender Mini, ensure there is proper ventilation to all sides and in front of the extender. Do not plug in the unit behind furniture, curtains, or anything that obstructs its air flow.*

5. Once the light turns solid white, your setup is complete.

You're all set! Your Wi-Fi Extender Mini will automatically connect to your Wi-Fi network, there is nothing more to do.

*Note: If there is an error during the WPS pairing process, the Status LED slowly flashes red for two minutes after the error occurs.*

## **2.1b/ Wired Installation with Fios Extender**

1. Connect the Verizon Router to a coax outlet. (If the coax outlet is already in use, use a coax splitter.)
2. Connect the extender to a coax outlet – ideally in an area with spotty Wi-Fi coverage.
3. Connect the power cords to your router and extender then to an electrical outlet.
4. After 10 minutes, the light on the extender should turn solid white, indicating the connection is complete.

*Note: If using Ethernet wiring, follow the same steps as above with an Ethernet cable instead of a coax cable.*

You're all set! Your devices will connect automatically with the same Wi-Fi network name and password as your Verizon Router.

## **2.2/ COMPUTER NETWORK CONFIGURATION**

Each network interface on your computer should either automatically obtain an IP address from the upstream Network DHCP server (default configuration) or be manually configured with a statically defined IP address and DNS address. We recommend leaving this setting as it is.

### **2.2a/ CONFIGURING DYNAMIC IP ADDRESSING**

*To configure a computer to use dynamic IP addressing:*

#### **WINDOWS 7/8**

1. In the Control Panel, locate **Network and Internet**, then select **View Network Status and Tasks**.
2. In the **View your active networks – Connect or disconnect** section, click **Local Area Connection** in the **Connections** field. The Local Area Connection Status window displays.
3. Click **Properties**. The Local Area Connection Properties window displays.



# COMPUTER NETWORK CONFIGURATION

---

4. Select **Internet Protocol Version 4 (TCP/IPv4)**, then click **Properties**. The Internet Protocol Version 4 (TCP/IPv4) Properties window displays.
5. Click the **Obtain an IP address automatically** radio button.
6. Click the **Obtain DNS server address automatically** radio button, then click **OK**.
7. In the Local Area Connection Properties window, click **OK** to save the settings.
8. To configure Internet Protocol Version 6 (TCP/IPv6) to use dynamic IP addressing, repeat steps 1 to 7. However for step 4, select **Internet Protocol Version 6 (TCP/IPv6)** in the **Properties** option (refer to IPv6 section for Verizon Router configuration).

## WINDOWS 10

1. On the Windows desktop, click on the **Start** icon. Select **Settings** and click **Network & Internet**.
2. In the Network & Internet, click **Ethernet**.
3. Select **Network and Sharing Center**. The **View your basic network information and set up connections** window displays.
4. In the **View your active networks**, click **Ethernet** in the **Connections** field. The **Ethernet Status** window displays.
5. Click **Properties**. The **Ethernet Properties** window displays.

6. Select **Internet Protocol Version 4 (TCP/IPv4)**, then click **Properties**. The **Internet Protocol Version 4 (TCP/IPv4) Properties** window displays.
7. Click the **Obtain an IP address automatically** radio button.
8. Click the **Obtain DNS server address automatically** radio button, then click **OK**.
9. In the **Local Area Connection Properties** window, click **OK** to save the settings.
10. To configure Internet Protocol Version 6 (TCP/IPv6) to use dynamic IP addressing, repeat steps 1 to 9. However for step 6, select **Internet Protocol Version 6 (TCP/IPv6)** in the **Properties** option (refer to IPv6 section for Verizon Router configuration).

## MACINTOSH OS X

1. Click the **Apple** icon in the top left corner of the desktop. A menu displays.
2. Select **System Preferences**. The System Preferences window displays.
3. Click **Network**.
4. Verify that **Ethernet**, located in the list on the left, is highlighted and displays **Connected**.
5. Click **Assist Me**.
6. Follow the instructions in the Network Diagnostics Assistant.

# COMPUTER NETWORK CONFIGURATION

---

## **2.2b/ CONNECTING OTHER COMPUTERS AND NETWORK DEVICES**

You can connect your Verizon Router to other computers or set top boxes using an Ethernet cable, Wi-Fi connection (Wi-Fi), or coaxial cable.

### **ETHERNET**

1. Plug one end of an Ethernet cable into one of the open Ethernet ports on the back of your Verizon Router.
2. Plug the other end of the Ethernet cable into an Ethernet port on the computer.
3. Repeat these steps for each computer to be connected to your Verizon Router using Ethernet. You can connect up to three.

### **CONNECTING A WI-FI DEVICE USING WPS**

Wi-Fi Protected Setup (WPS) is an easier way for many devices to set up a secure Wi-Fi network connection. Instead of manually entering passwords or multiple keys on each Wi-Fi client, such as a laptop, printer, or external hard drive, your Verizon Router creates a secure Wi-Fi network connection.

In most cases, this only requires the pressing of two buttons – one on your Verizon Router and one on the Wi-Fi client. This could be either a built-in button or one on a compatible Wi-Fi adapter/card, or a virtual button in software. Once completed, this allows Wi-Fi clients to join your Wi-Fi network.

To initialize the WPS process, you can either press and hold the WPS button located on the rear of your Verizon Router for more than two seconds or use the UI and press the on-screen button.

You can easily add Wi-Fi devices to your Wi-Fi network using the WPS option if your Wi-Fi device supports the WPS feature.

*To access WPS using the user interface:*

1. From the **Basic** menu, select **Wi-Fi** settings, then click **Wi-Fi Protected Setup**.

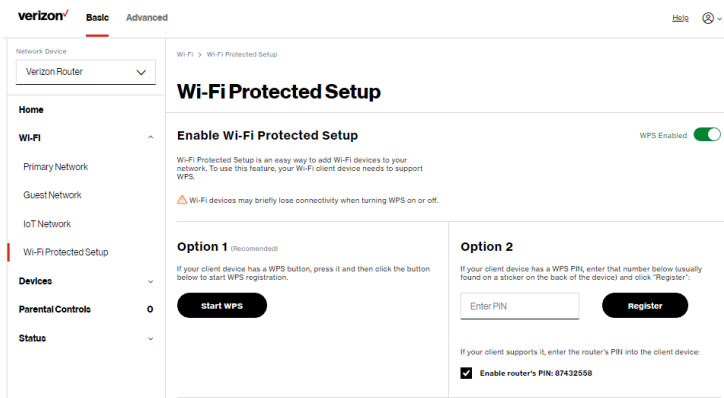

2. Enable the protected setup by moving the selector to **on**.
3. Use one of the following methods:
  - If your Wi-Fi client device has a WPS button, press the WPS button on your router for more than two seconds, then click the **start WPS** button in the **Option 1** to start the WPS registration process.

# COMPUTER NETWORK CONFIGURATION

---

- If your client device has a WPS PIN, locate the PIN printed on the client's label or in the client documentation. Enter the PIN number in the **Enter PIN** field. The **Client WPS PIN** field is located in the **Option 2** on the user interface.
  - Click **Register**.
  - Alternatively, you can enter the router's PIN shown on this screen into the WPS user interface of your device, if this PIN mode is supported by your Wi-Fi device.
4. After pressing the WPS button on your router, you have two minutes to press the WPS button on the client device before the WPS session times out.

When the WPS button on your router is pressed, the Router Status LED on the front of your router begins flashing blue. The flashing continues until WPS pairing to the client device completes successfully. At this time, the Router Status LED turns solid white.

If WPS fails to establish a connection to a Wi-Fi client device within two minutes, the Router Status LED on your router flashes red for two minutes to indicate the WPS pairing process was unsuccessful. After flashing red, the light returns to solid white to indicate that Wi-Fi is on.

**Note:** *Wi-Fi Protected Setup (WPS) cannot be used if WPA3 security is enabled or SSID broadcast is disabled or if MAC address authentication is enabled with an empty white list.*

## CONNECTING A WI-FI DEVICE USING A PASSWORD

1. Verify each device that you are connecting with Wi-Fi has built-in Wi-Fi or an external Wi-Fi adapter.
2. Open the device's Wi-Fi settings application.
3. Select your Verizon Router's Wi-Fi network name (SSID) from the device's list of discovered Wi-Fi networks.
4. When prompted, enter your Verizon Router's Wi-Fi password (WPA2 or WPA3 key) into the device's Wi-Fi settings. Your router's default Wi-Fi network name and password are located on the sticker on the rear panel of your Verizon Router.

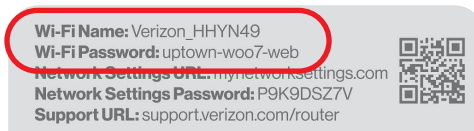

5. Verify the changes were implemented by using the device's web browser to access a site on the internet.
6. Repeat these steps for every device that you are connecting with Wi-Fi to your router.

## COAX

1. Verify all coax devices are turned off.
2. Disconnect any adapter currently connected to the coaxial wall jack in the room where your router is located.
3. Connect one end of the coaxial cable to the coaxial wall jack and the other end to the coax port on your network device.
4. Power up the network device.

# MAIN SCREEN

## 2.3/ MAIN SCREEN

When you log into your router, the dashboard main page displays the navigation menus of Basic and Advanced settings, Wi-Fi settings, Devices, Parental Controls, and connection status, and Basic quick links.

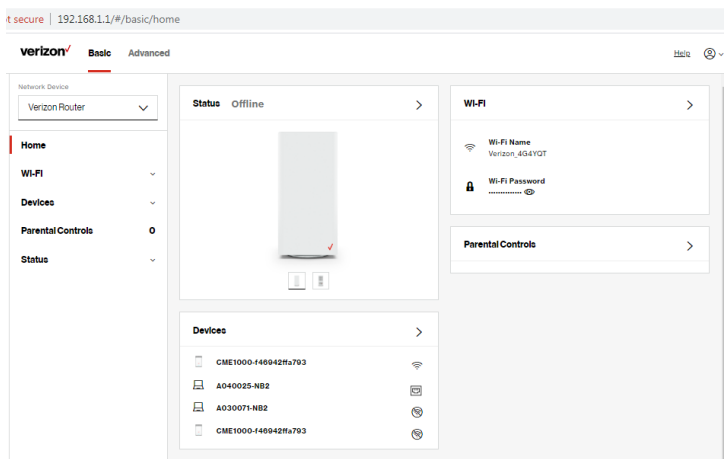

The configuration options available via the left-hand main menu are described in the following chapters:

- Basic Settings
  - Status - this chapter
  - Wi-Fi - Chapter 3
  - Devices - Chapter 4
  - Parental Controls - Chapter 5
- Advanced Settings - Chapter 6

## 2.3c/ STATUS

### General

*To view the status:*

Access the dashboard Home page . You can quickly view your router's status by clicking **Status** > on the screen. This section displays the status of your router's local network (LAN) and internet connection (WAN), firmware and hardware version numbers, MAC Address, IP settings of Verizon Router and Extender Mini(s) (if connected).

The screenshot displays the Verizon Router Status page. The interface includes a navigation menu on the left with options like Home, Wi-Fi, Devices, Parental Controls, Status, General, and Open Source Software. The main content area is titled 'Status' and is divided into two columns: 'Broadband IPv4' and 'Broadband IPv6'. The 'Broadband IPv4' section shows a status of 'Disconnected' and lists fields for IP address, Subnet Mask, and IPv4 Default Gateway. The 'Broadband IPv6' section also shows a status of 'Disconnected' and lists fields for IP address, Link Local Address, and IPv6 Default Gateway. Below these sections is a 'Router' section with fields for Firmware Version (3.10.12-eng0), Hardware Version (0.0.4), Model Name (CR1000A), and Serial Number (AAK11300274). The page also features an 'Auto-refresh' toggle and a 'Refresh' button.

Network Device	Status > General
Verizon Router	<b>Status</b> Auto-refresh Refresh
<b>Home</b>	
<b>Wi-Fi</b>	
<b>Devices</b>	
<b>Parental Controls</b>	
<b>Status</b>	
<b>General</b>	
<b>Open Source Software</b>	
	<b>Broadband IPv4</b>
	Status: Disconnected
	IPv4 address is from: DHCP
	IPv4 address
	Subnet Mask
	IPv4 Default Gateway
	IPv4 DNS Address 1
	IPv4 DNS Address 2
	NAT's Supported (used / max): 0 / 30000
	<b>Broadband IPv6</b>
	Status: Disconnected
	IPv6 address is from: DHCPv6 PD
	Delegated Prefix
	IPv6 Address
	Link Local Address
	IPv6 Default Gateway
	IPv6 DNS Address 1
	IPv6 DNS Address 2
	<b>Router</b>
	Firmware Version: 3.10.12-eng0
	Hardware Version: 0.0.4
	Model Name: CR1000A
	Serial Number: AAK11300274



# MAIN SCREEN

verizon Basic Advanced Library ⊙

Network Device  
Verizon Router

Home  
Wi-Fi  
Devices  
Parental Controls 0  
Status  
General  
Open Source Software

Status > General

### Status

Auto-refresh  Refresh

Model Name  
CR100GA

Serial Number  
AAK1300274

LAN IP4 Address  
192.168.1.1

Broadband MAC address  
88:5A:85:F5:C5:65

Broadband Physical Connection  
Disconnected

Router has been active for  
0 day(s) 5 hours 15 minutes 30 seconds

---

#### Extender

Device Name  
CME1000-46942F7A793

Model Name  
CME1000

Firmware Version  
31.0.7-english

Hardware Version  
3

Serial Number  
AAK1300283

MAC Address  
F4:69:42:F7:A7:93

verizon Basic Advanced Library ⊙

Network Device  
Verizon Router

Home  
Wi-Fi  
Devices  
Parental Controls 0  
Status  
General  
Open Source Software

Status > General

### Status

Auto-refresh  Refresh

MAC Address  
F4:69:42:F7:A7:93

System Up Time  
0 day(s) 5 hours 15 minutes 4 seconds

Backhaul Type  
6 GHz

Backhaul Type  
Wi-Fi

PHY Rate  
4.8 Gbps

Wi-Fi Band  
6 GHz

Wi-Fi Protocol  
AX

Channel  
Ch. 37

Channel Width  
160 MHz

Security  
WPA3

IPv4 Address  
192.168.1.101

IPv6 Address

Subnet Mask  
255.255.255.0

Default Gateway  
192.168.1.1

## 2.3d/ OPEN SOURCE SOFTWARE

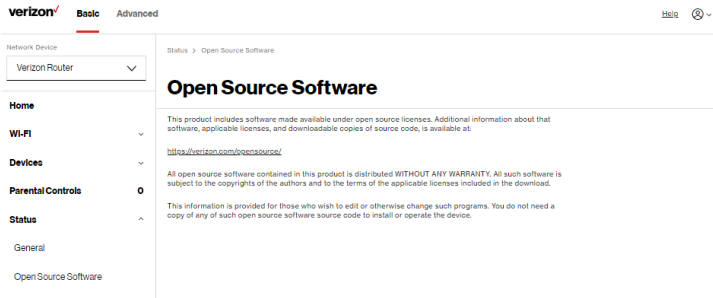

*To view:* From the **Basic** menu, select **Status** from the left pane and then click **Open Source Software**.

---

# 03 /

## WI-FI SETTINGS

- 3.0** Overview
- 3.1** Basic Settings
- 3.2** Advanced Settings

---

Wi-Fi networking enables you to free yourself from wires, making your devices more accessible and easier to use.

You can create a Wi-Fi network, including accessing and configuring Wi-Fi security options.

# OVERVIEW

---

## **3.0/ OVERVIEW**

Your Verizon Router provides you with Wi-Fi connectivity using the 802.11a, b, g, n, ac or ax standards. These are the most common Wi-Fi standards.

The Verizon Router contains 2.4 GHz, 5 GHz and 6 GHz Wi-Fi bands, and the operation modes and speeds are listed as follows:

- 2.4 GHz
  - Legacy operation mode: supports IEEE 802.11b/g/n with maximum theoretical rate at 600 Mbps
  - Compatibility mode: supports IEEE 802.11ax
    - backward compatible with IEEE 802.11b/g/n/ac
    - maximum theoretical rate up to 1.1 Gbps
- 5 GHz
  - Legacy operation mode: supports IEEE 802.11a/n/ac with maximum theoretical rate at 2.2 Gbps
  - Compatibility mode: supports IEEE 802.11ax
    - backward compatible with IEEE 802.11a/n/ac
    - maximum theoretical rate up to 2.4 Gbps
- 6 GHz
  - Operation mode: supports IEEE 802.11ax
  - Maximum rate up to 4.8 Gbps

The Wi-Fi service and Wi-Fi security are activated by default. The level of security is preset to WPA2 encryption using a unique default WPA2 key (also referred to as a passphrase or password) pre-configured at the factory. This information is displayed on a sticker located on the rear of your router.

Your router integrates multiple layers of security. These include Wi-Fi Protected Access, and firewall.

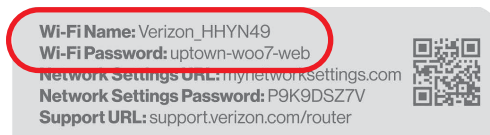

## 3.1/ BASIC SETTINGS

### 3.1a/ PRIMARY NETWORK

You can configure the basic security settings for 2.4 GHz, 5 GHz or 6 GHz of your Wi-Fi network.

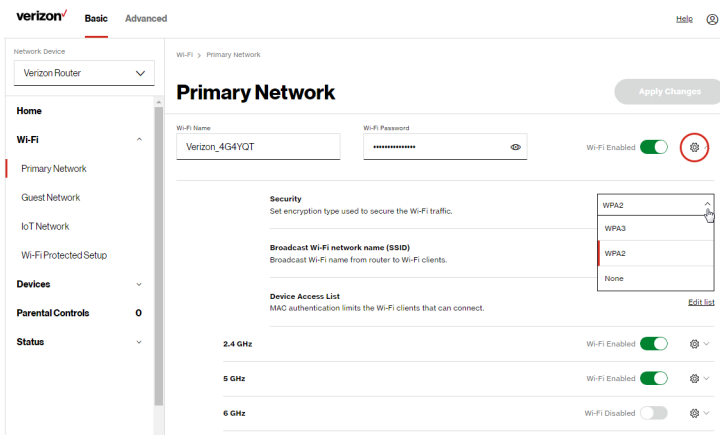

# BASIC SETTINGS

To configure the Primary Wi-Fi name & password and security settings:

1. From the **Basic** menu, select **Wi-Fi** from the left pane and then click **Primary Network**.
2. By default the Primary Wi-Fi is enabled. To de-activate, move the selector to **off**. If the network is not enabled, no Wi-Fi devices will be able to connect to the primary network.
3. If desired, enter a new name and password for the Wi-Fi network or leave the default name and password that displays automatically.
4. To configure the Wi-Fi **Security**, click the setup ⚙️ button and select **WPA2** or **WPA3**.

You can optionally enable the 6 Ghz Wi-Fi band by toggling the selection to **On**. Enabling 6 GHz will modify the existing 2.4 & 5 GHz security from WPA2 to WPA2/WPA3 and 6 GHz will be enabled using WPA3.

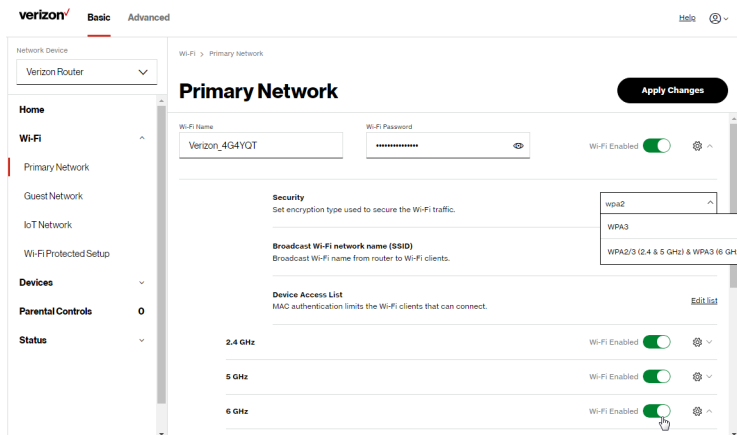

---

***Caution:** These settings should only be configured by experienced network technicians. Changing the settings could adversely affect the operation of your router and your local network.*

- **Broadcast Wi-Fi network name (SSID)**

You can configure the Verizon Router's SSID broadcast capabilities to allow or disallow Wi-Fi devices from automatically using a broadcast SSID name to detect your router Wi-Fi network.

- To enable SSID broadcasting, move the selector to **on**. SSID broadcast is enabled by default. The SSID of the Wi-Fi network will be broadcast to all Wi-Fi devices.
- To disable SSID broadcasting, move the selector to **off**. The public SSID broadcast will be hidden from all Wi-Fi devices. You will need to manually configure additional Wi-Fi devices to join the Wi-Fi network.

- **Device Access List**

You can configure your router to limit access to your Wi-Fi network to only those devices with specific MAC addresses.



# BASIC SETTINGS

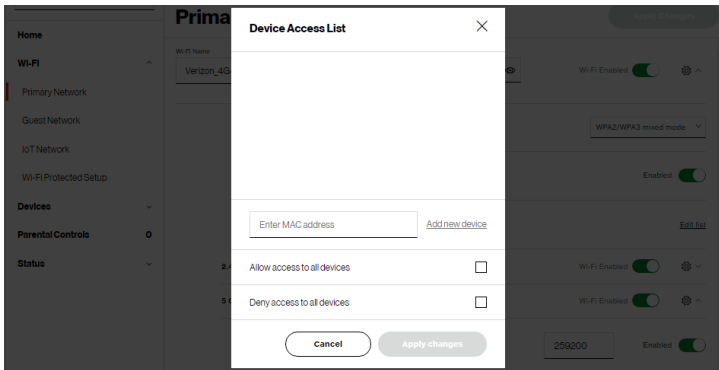

To set Wi-Fi MAC authentication:

1. To setup access control, click on the **Edit List**.
2. Enter the MAC address of a device and click **Add new device**.
3. Select either:
  - **Allow access to all devices** – allows the listed devices to access the Wi-Fi network.

***Warning:** This will block Wi-Fi network access for all devices not in the list. Only devices in the list will be able to connect to the Wi-Fi network.*

- **Deny access to all devices** – denies access to the listed devices. All other Wi-Fi devices will be able to access the Wi-Fi network if they use the correct Wi-Fi password.
4. Repeat step 2 and step 3 to add additional devices, as needed.
  5. When all changes are complete, click **Apply changes** to save the changes.

To activate the Wi-Fi 2.4 GHz, 5 GHz or 6 GHz frequency for your Wi-Fi network, move the selector to **on**, click the setup  button and configure access security of your Wi-Fi network.

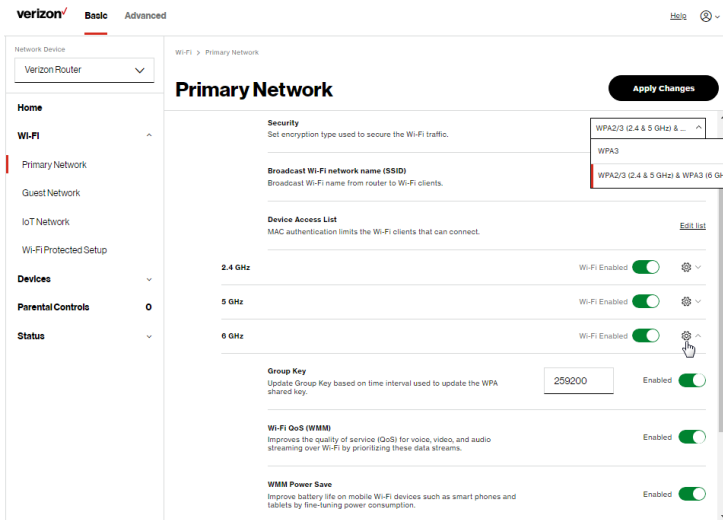

The screenshot shows the 'Primary Network' configuration page. On the left is a navigation menu with 'Wi-Fi' selected. The main content area is titled 'Primary Network' and includes an 'Apply changes' button. The settings are as follows:

- Security:** WPA2/G (2.4 & 5 GHz & ...)
- Broadcast Wi-Fi network name (SSID):** WPA3
- Device Access List:** MAC authentication limits the Wi-Fi clients that can connect. Includes a 'Edit List' link.
- 2.4 GHz:** Wi-Fi Enabled (toggle on), gear icon.
- 5 GHz:** Wi-Fi Enabled (toggle on), gear icon.
- 6 GHz:** Wi-Fi Enabled (toggle on), gear icon.
- Group Key:** Update Group Key based on time interval used to update the WPA shared key. Value: 259200. Enabled (toggle on).
- Wi-Fi QoS (WMM):** Improves the quality of service (QoS) for voice, video, and audio streaming over Wi-Fi by prioritizing these data streams. Enabled (toggle on).
- WMM Power Save:** Improve battery life on mobile Wi-Fi devices such as smart phones and tablets by fine-tuning power consumption. Enabled (toggle on).

- **Group key** - to update the WPA shared key, move the selector to **on**.
- **Wi-Fi QoS (WMM)** - improves the quality of service (QoS) for voice, video, and audio streaming over Wi-Fi by prioritizing these data streams.
- **WMM Power Save** - improves battery life on mobile Wi-Fi devices such as smart phones and tablets by fine-tuning power consumption.

# BASIC SETTINGS

## 3.1b/ GUEST NETWORK

The **Guest Network** is designed to provide internet connectivity to your guests but restricts access to your primary network and shared files. The primary network and the guest network are separated from each other through firewalls. You create one Guest Wi-Fi SSID and one password, and use it for all guests. The guest network SSID does not change when you make a change to your primary network SSID.

The Verizon Router is shipped from the factory with Guest Wi-Fi turned off. The default SSID for Guest Wi-Fi is preconfigured at the factory to the default Wi-Fi network name (SSID) which is displayed on a sticker located at the rear of the router followed by hyphen guest (-Guest). For example – if the router is shipped with a default SSID of “Verizon-ABCDE” then the default SSID for Guest Wi-Fi is “Verizon-ABCDE-Guest”.

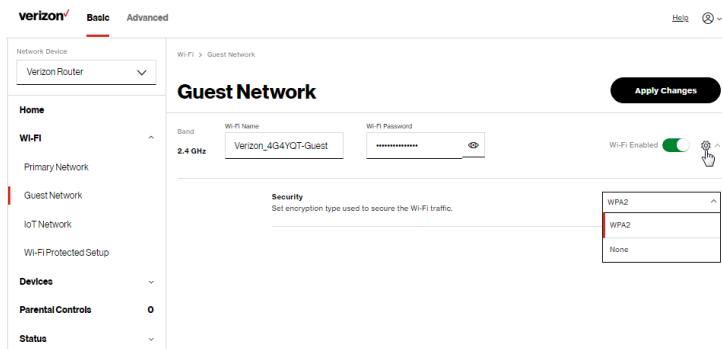

*To configure the security settings for your guest network:*

1. From the **Basic** menu, select **Wi-Fi** and then click **Guest Network**.

2. Move the selector to **on**.
3. If desired, enter a new name and password for the Wi-Fi network or leave the default name and password that displays automatically.
4. Press **Apply changes** to save the changes.

***Important:** It is not recommended to create a guest network without a password.*

### **3.1c/ IOT NETWORK**

The router supports connection of multiple IoT devices on a separate WiFi SSID. The IoT Network is designed to provide an easier setup experience for your Internet of Things (IoT) devices which benefit from connecting to the 2.4 GHz band while keeping your Primary Network settings unchanged. IoT devices and Primary devices can communicate with no firewall restrictions separating them.

The Verizon Router is shipped from the factory with IoT Wi-Fi turned off. The default SSID for IoT Wi-Fi is preconfigured at the factory to the default Wi-Fi network name (SSID) which is displayed on a sticker located at the rear of the router followed by hyphen IoT (-IoT). For example – if the router is shipped with a default SSID of “Verizon-ABCDE” then the default SSID for IoT Wi-Fi is “Verizon-ABCDE-IoT”.

# BASIC SETTINGS

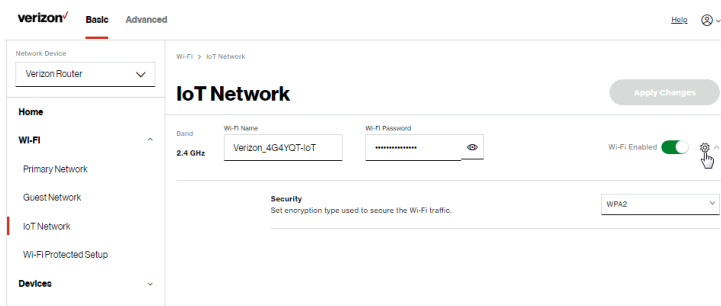

*To enable IoT Wi-Fi link:*

1. From the **Basic** menu, select **Wi-Fi** and then click **IoT Network**.
2. Move the selector to **on**.
3. If desired, enter a new name and password for the Wi-Fi network or leave the default name and password that displays automatically.
4. Press **Apply changes** to save the changes.

## **3.1d/ WI-FI PROTECTED SETUP (WPS)**

Wi-Fi Protected Setup (WPS) is an easier way for many devices to set up a secure Wi-Fi network connection. Instead of manually entering passwords or multiple keys on each Wi-Fi client, such as a laptop, printer, or external hard drive, your Verizon Router creates a secure Wi-Fi network connection.

In most cases, this only requires the pressing of two buttons – one on your Verizon Router and one on the Wi-Fi client. This could be

either a built-in button or one on a compatible Wi-Fi adapter/card, or a virtual button in software. Once completed, this allows Wi-Fi clients to join your Wi-Fi network.

To initialize the WPS process, you can either press and hold the WPS button located on the front of your Verizon Router for more than two seconds or use the UI and press the on-screen button.

You can easily add Wi-Fi devices to your Wi-Fi network using the WPS option if your Wi-Fi device supports the WPS feature.

*To access WPS using the user interface:*

1. From the **Basic** menu, select **Wi-Fi** and then click **Wi-Fi Protected Setup (WPS)**.

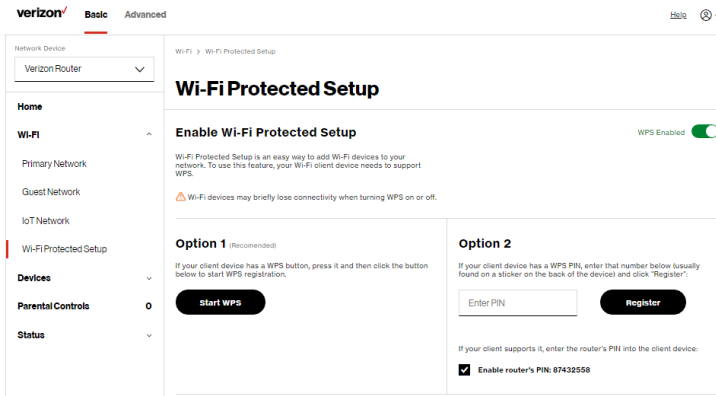

# BASIC SETTINGS

---

2. Enable the protected setup by moving the selector to **on**.
3. Use one of the following methods:
  - If your Wi-Fi client device has a WPS button, press the WPS button on your router for more than two seconds, then click the **start WPS** button in the **Option 1** to start the WPS registration process.
  - If your client device has a WPS PIN, locate the PIN printed on the client's label or in the client documentation. Enter the PIN number in the **Enter PIN** field. The **Client WPS PIN** field is located within **Option 2** on the user interface.
  - Click **Register**.
  - Alternatively, you can enter the router's PIN shown on this screen into the WPS user interface of your device, if this PIN mode is supported by your Wi-Fi device.
4. After pressing the WPS button on your router, you have two minutes to press the WPS button on the client device before the WPS session times out.

When the WPS button on your router is pressed, the Router Status LED on the front of your router begins flashing blue. The flashing continues until WPS pairing to the client device completes successfully. At this time, the Router Status LED turns solid blue.

If WPS fails to establish a connection to a Wi-Fi client device within two minutes, the Router Status LED on your

router flashes red for two minutes to indicate the WPS pairing process was unsuccessful. After flashing red, the light returns to solid white to indicate that Wi-Fi is on.

**Note:** *Wi-Fi Protected Setup (WPS) cannot be used if WPA3 security is enabled or SSID broadcast is disabled or if MAC address authentication is enabled with an empty white list.*

## 3.2/ ADVANCED SETTINGS

### 3.2a/ PRIMARY NETWORK

#### Self-Organizing Network (SON)

The Verizon Router supports 2.4 GHz, 5 GHz and 6 GHz signals. The Self-Organizing Network (SON) feature lets your devices move between these signals automatically for an optimized Wi-Fi connection.

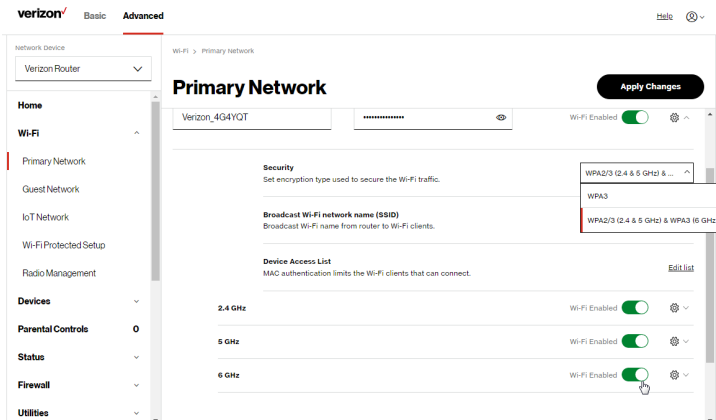



# ADVANCED SETTINGS

To configure SON, Primary Wi-Fi name & password and security settings:

1. From the **Advanced** menu, select **Wi-Fi** from the left pane and then click **Primary Network**.
2. To enable SON, move the selector to **on**.
3. By default the Primary Wi-Fi is enabled. To de-activate, move the selector to **off**. If the network is not enabled, no Wi-Fi devices will be able to connect to the primary network.
4. If desired, enter a new name and password for the Wi-Fi network or leave the default name and password that displays automatically.
5. To configure the Wi-Fi security, click the setup  button and select **WPA2** or **WPA3**.

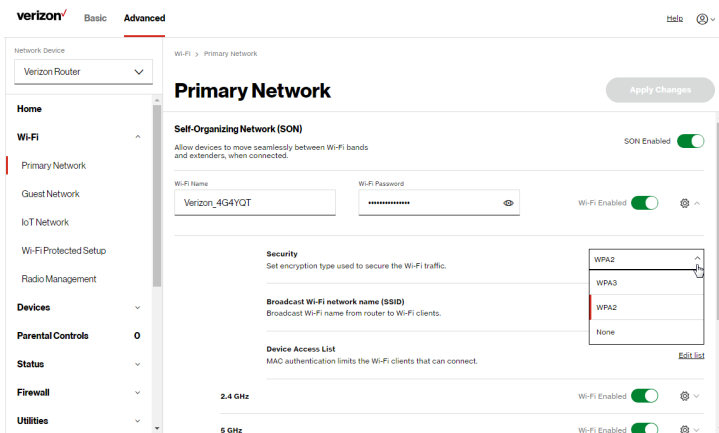

**Caution:** These settings should only be configured by experienced network technicians. Changing the settings could adversely affect the operation of your router and your local network.

### 3.2b/ RADIO MANAGEMENT

You can configure the channel settings for the 2.4 GHz, 5 GHz and 6 GHz band(s) of your Wi-Fi network.

The screenshot displays the Verizon router's 'Radio Management' settings page. The page is divided into a left-hand navigation menu and a main content area. The navigation menu includes options for Home, Wi-Fi, Primary Network, Guest Network, IoT Network, Wi-Fi Protected Setup, Radio Management (highlighted), Devices, Parental Controls, Status, Firewall, Utilities, Network Settings, Date & Time, and DNS Settings. The main content area is titled 'Radio Management' and features an 'Apply changes' button. Below this, there are two tabs: 'Settings' (selected) and 'History'. The 'Channel Analysis' section contains two graphs: one for 2.4 GHz (Channels 1-11) and one for 5 GHz (Channels 1-14). The 2.4 GHz graph shows a score of 1 for channel 1. The 5 GHz graph shows signal strength across channels 1-14. Below the graphs is the 'Channel Settings' table:

Band	Channel	Width	Health	Radio Enabled
2.4 GHz	Ch. 1 (Auto)	20/40MHz	157	<input checked="" type="checkbox"/>
5 GHz	Ch. 135 (Auto)	80MHz	196	<input checked="" type="checkbox"/>
6 GHz	Auto	100MHz	Not available	<input checked="" type="checkbox"/>

# ADVANCED SETTINGS

---

To view and configure the channel settings:

1. From the **Advanced** menu, select **Wi-Fi** and then click **Radio Management**.
2. Click on **Settings** on the top right-hand side of the **Radio Management** page to configure the channel scan settings:

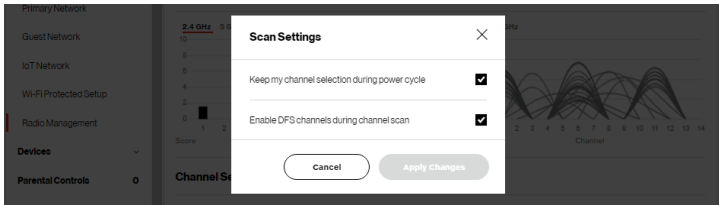

- Select the **Keep my channel selection during power cycle** check box to save your channel selection when your Verizon Router is rebooted.
- **Enable DFS channels during channel scan:** DFS channels are enabled by default during channel scans.

***Note:** DFS channels are a subset of the 5 GHz network that is shared with radar systems. Some consumer devices do not support these channels and cannot connect to routers using them. Examples include some media streaming devices. Disabling this feature will allow the router to select the best available channel to broadcast on and allow these devices to connect.*

- Press **Apply changes** to save the changes.

3. Click **Perform Scan** to perform channel availability scan for the Verizon Router accommodating the best radio channel and providing the best Wi-Fi performance.
4. On the **Radio Management** page for 2.4 GHz, 5 GHz or 6 GHz, the following information displays and can be configured:
  - **Channel Score** - displays a network congestion score of one to ten in each Wi-Fi channel. It can be used to determine which channels to use or to avoid. Higher score indicates less congestion in a channel.
  - **Channel Analysis** - scans and displays channel bandwidth and signal strength of available APs.
  - **Channel** - this is the radio channel used by the Wi-Fi router and its clients to communicate with each other. The channel must be the same on the router and all of its Wi-Fi clients. Select the channel you want the Wi-Fi radio to use to communicate, or accept the default (**Auto**) channel selection. Then the router will automatically assign itself a radio channel.
  - **Width** - displays the Wi-Fi channel currently in use on each band. Users can select from available channels.

# ADVANCED SETTINGS

To view the channel settings history:

1. From the **Advanced** menu, select **Wi-Fi** and then click **Channel Settings**.
2. Click on **History** to display the channel settings history.

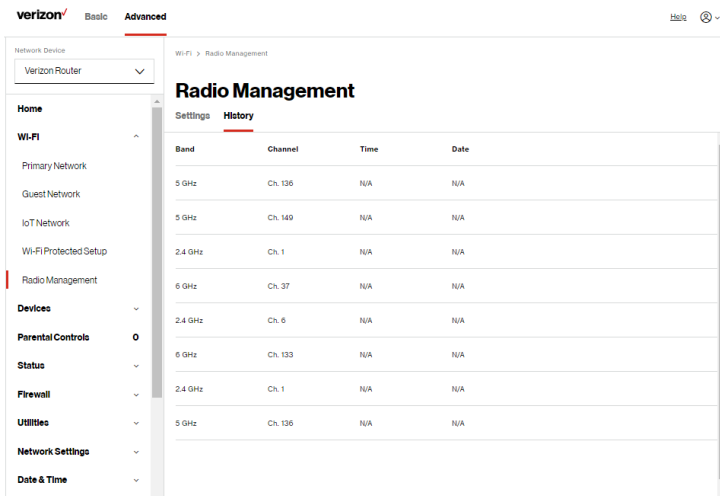

---

04 /

# CONNECTED DEVICES

**4.0** Overview

**4.1** Device Settings

You can view the settings of the network devices connected to your Verizon Router's network.

# OVERVIEW

---

## 4.0/ OVERVIEW

The **Devices** section allows you to view and manage all the devices connected to your Primary, Guest, and IoT networks. You can view device details, block internet service, and rename devices.

## 4.1/ DEVICE SETTINGS

*To view and manage the connected devices on your network:*

1. From the **Basic** menu, select **Devices** from the left pane.
2. The screen displays information about connected devices including **Device Name** and identifiers, **Parental Controls**, the type of network connection, and settings that you can view and configure.
3. The Verizon Router provides a sort function for listing connected devices in a meaningful order. For example, select **Sort A to Z** from the dropdown list to view the connected device in alphabetical order.

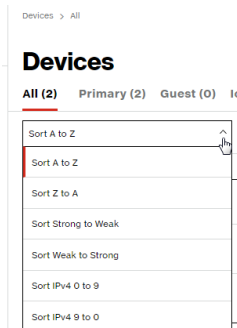

4. Select **Show All** from the dropdown list to display all devices on your network.



5. Select **Expanded List** from the dropdown list to view additional device information for all connected devices.

The screenshot shows the Verizon router's web interface. The 'Basic' tab is selected. On the left, a navigation menu includes 'Home', 'Wi-Fi', 'Devices', 'Parental Controls', and 'Status'. The 'Devices' section is active, showing a list of devices. At the top right of the 'Devices' section, there is a dropdown menu with three options: 'Expanded List', 'Compact List', and 'Expanded List'. The 'Expanded List' option is highlighted with a red box. Below the dropdown, the 'Online' section lists two devices:

Device Name	Parental Controls	Connection	Status	Settings
A040025-NB2	None	Ethernet	Online	Settings icon
CME1000-146942fa793	None	Wi-Fi 5 GHz	Online	Settings icon

The 'Offline' section shows one device:

Device Name	Parental Controls	Connection	Status	Settings
A030071-NB2	None	Offline	Offline	Settings icon

The URL at the bottom left is `devices/list/settings/146942ffa793`.

- **Block/Allow** - Click this option to quickly enable/disable a device from having internet access.

For additional information about blocking websites, refer to Chapter 5 Setting Parental Controls.

6. Click the Settings icon to access the Device Details page for that device:

# DEVICE SETTINGS

verizon **Basic** Advanced Help

Network Device  
Verizon Router

**Home**  
**Wi-Fi**  
**Devices**  
Devices 2  
**Parental Controls**  
Parental Controls 0  
**Status**

Devices > Device Settings

## Device Settings

[Reset to Default Settings](#) **Save**

### Device Information

Name: CME1000-146942ff793 Online

Location: Other

Mobility: Portable

Device Information: Edit

Type: Extender

### Device Add-Ons

Port Forwarding Rule [Go to Port Forwarding](#)

### Device Connection

Connection Info	Network Info
Connection Wi-Fi / 6 GHz	Mac Address 14:69:42:ff:a7:93

verizon **Basic** Advanced Help

Network Device  
Verizon Router

**Home**  
**Wi-Fi**  
**Devices**  
Devices 2  
**Parental Controls**  
Parental Controls 0  
**Status**

Devices > Device Settings

## Device Settings

[Reset to Default Settings](#) **Save**

Connection Wi-Fi / 6 GHz	Mac Address 14:69:42:ff:a7:93
Connection Type 802.11ax	Connected to CR1000A
Frequency 6	IPv4 Address 192.168.1.101
Protocol Supported AX	Subnet Mask 255.255.255.0
Radio Configuration 4 x 4 / 4	IPv4 Address Allocation Dynamic
PHY Rate / Modulation Rate 4691 Mpps	Lease Type DHCP
RSSI -27	IPv6 LAN Prefix 0/0
SNR 66	IPv6 Global
	IPv6 Type / Address Allocation Static
	IPv6 link-local
	Network Connection Bridge
	Ping Test <a href="#">Test Connectivity</a>

[/diagnostics](#)

---

– **Device Information:**

- **Name, Location, Mobility, and Type** - Displays the current known information of the device. These can be updated or corrected as needed. Click **Edit** and **Save** to apply any changes.
- This section also provides the device MAC Address, Access Point information the device is connected to as well as the IPv4 Address of the device.

– **Device Add-Ons**

**Port Forwarding** - Port Forwarding allows your network to be exposed to the internet in specific limited and controlled ways. For example, you could allow specific applications, such as gaming, voice, and chat, to access servers in the local network. To access the Port Forwarding page, click **Go to Port Forwarding**.

For additional information, refer to the Port Forwarding section in Chapter 6 Configuring Advanced Settings.

If any Port Forwarding Rules are applied to this device, then the first row of that rule will be displayed here.

– **Device Connection**

This section displays Connection information of how and how well the device is connected to the Access Point. It also displays the Network related information, including IPv6 addresses and a **Ping Test** option.

---

05 /

# SETTING PARENTAL CONTROLS

**5.0** Activating Parental Controls

**5.1** Active Rules

The abundance of harmful information on the internet poses a serious challenge for employers and parents alike as they ask “How can I regulate what my employee or child does on the internet?”

With that question in mind, your Verizon Router’s Parental Controls were designed to allow control of internet access on all locally networked devices.

# ACTIVATING PARENTAL CONTROLS

## 5.0/ ACTIVATING PARENTAL CONTROLS

You can create a basic access policy or using the provided **Rule Templates** for any computer or device on your Verizon Router network. Parental controls limit internet access to specific websites based on a schedule that you create.

Access can be limited on specific websites or keywords embedded in a website. For example, you can block access to the 'www.anysite.com' as well as block any website that has the word 'any' in its site name.

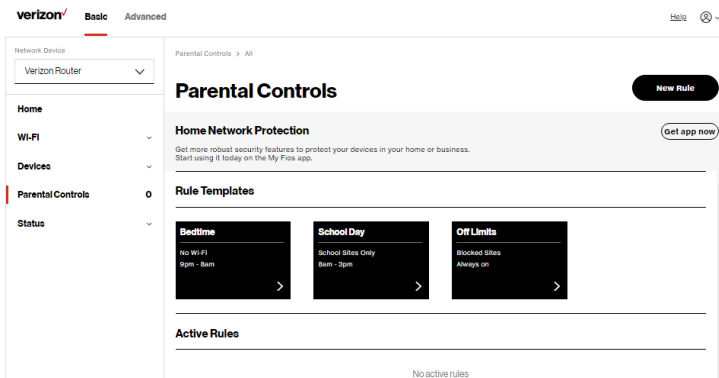

*To limit device access:*

1. From the **Basic** menu, select **Parental Controls** from the left pane.
2. To use the default **Rule Templates**, select one of the pre-defined rules as shown on screen to quickly setup access policy for devices on your network.

- To create a new access policy, click on the **New Rule** and the configuration page displays.

verizon Basic Advanced Help

Network Device: Verizon Router

Parental Controls > All Apply Changes

### Create New Rule

**Name:** -- Required [Change rule name](#)

Rule Name  Done

**Days:** -- Required [Change days when rule is active](#)

Days: Sun Mon Tue Wed Thu Fri Sat Done

**Time:** -- Required [Change time when rule is active](#)

Start Time: 12:00 am End Time: 12:00 am Done

**Condition:** -- Required [Change rule condition](#)

All Internet OFF

verizon Basic Advanced Help

Network Device: Verizon Router

Parental Controls > All Apply Changes

### Create New Rule

12:00 am 12:00 am Done

**Condition:** -- Required [Change rule condition](#)

All Internet OFF

All Internet ON

**Devices:** -- Required [Assign devices to this rule](#)

**Exceptions (Websites):** -- Optional [Make exceptions to this rule](#)

Enter a specific URL such as www.example.com

Enter website Add

**Exceptions (URL Keywords):** -- Optional [Make exceptions to this rule](#)

Enter a word that appears within a URL

Enter keyword Add

# ACTIVATING PARENTAL CONTROLS

---

4. Create a rule name.
5. Create a schedule by selecting the days of the week when the rule will be active or inactive.
6. Set the time when the rule will be active or inactive, then specify the start time and end time.
7. Select the **Condition** rule of **All Internet OFF/All Internet ON** to block/allow the access to all internet websites.
8. Click **Assign devices to this rule** to select the computers or device where you are limiting access. Click **Apply** to save changes.

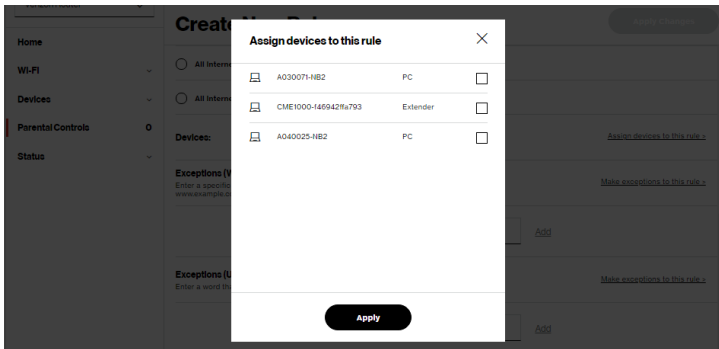

9. To remove a device from the list, click **Remove** to the assigned device.
10. Click **Make exceptions to this rule** for the following **Exceptions** options:
  - Enter the name of the website or keywords within a URL to block/allow the specified websites and websites with names containing the specified keyword .



11. To remove a website or keyword, click **Remove** to the word.
12. Click **Apply changes** to save changes.

**NEW!** The **Verizon** app provides robust security to protect your home and business networks. Click the **Get app now** link to download the Verizon app for using the

Verizon app on the iOS or Android OS.

## 5.1/ ACTIVE RULES

You can view the rules created for your Verizon Router shown on the **Parental Controls** page.

verizon Basic Advanced

Parental Controls > All

### Parental Controls

New Rule

Get app now

#### Home Network Protection

Get more robust security features to protect your devices in your home or business. Start using it today on the My First app.

#### Rule Templates

- Bedtime**  
No Wi-Fi  
9pm - 8am
- School Day**  
School Sites Only  
8am - 3pm
- Off Limits**  
Blocked Sites  
Always on

#### Active Rules

Bedtime	All Internet Off Sun, Mon, Tue, Wed, Thu, Fri, Sat 9:00pm - 8:00 am	unknown_b8185384e669	Enabled	Remove Edit
---------	---	----------------------	---------	-------------

---

06 /

# CONFIGURING ADVANCED SETTINGS

- 6.0** Firewall
- 6.1** Utilities
- 6.2** Network Settings
- 6.3** Date & Time
- 6.4** DNS Settings
- 6.5** Monitoring
- 6.6** System Settings

Advanced settings cover a wide range of sophisticated configurations for your Verizon Router's firmware, security setup and network.

Verizon Router's security suite includes comprehensive and robust security services, such as stateful packet inspection, firewall security, user authentication protocols, and password protection mechanisms.

These and other features help protect your computers from security threats on the internet.

---

*This chapter covers the following advanced features:*

**Firewall** - select the security level for the firewall.

- Access Control - restrict access from the local network to the internet.
- Port Forwarding - enable access from the internet to specified services provided by computers on the local network.
- Port Triggering - define port triggering entries to dynamically open the firewall for some protocols or ports.
- DMZ Host - allows a single device on your primary network to be fully exposed to the internet for special purposes such as internet gaming.
- SIP ALG - support the Application Layer Gateway for Session Initiation Protocol
- Static NAT - allow multiple static NAT IP addresses to be designated to devices on the network.
- IPv6 Pinhole - provide access tunnel to a service on a host for a particular application.

**Utilities**

- Diagnostics – performs diagnostic tests.
- Save and Restore – resets your Verizon Router to its default settings.
- Reboot Router – restarts your Verizon Router.
- MAC Cloning – clones the MAC address.

- ARP Table – displays active devices with their IP and MAC addresses.
- NDP (Neighbor Discovery Protocol) Table – displays active devices with their IPv6 and MAC addresses of DHCP connection.
- Users – creates and manages remote users.
- Remote Administration – enable remote configuration of your Verizon Router from any internet-accessible computer.
- LED Brightness - controls the Router Status LED light to either dim or brighten and sets the dimming time of the LED light.

## Network Settings

- Network Objects – defines a group, such as a group of computers.
- Network Connections – displays and manages the details of a specific network connection.
- Universal Plug and Play (UPnP) – checks the validity of all UPnP services and rules.
- Port Forwarding Rules – displays port forwarding rules.
- IPv6 – enables IPv6 support.
- Routing – manages the routing and IP address distribution rules.
- IPv4/IPv6 Address Distribution - adds computers configured as DHCP clients to the network.
- Port Configuration – sets up the Ethernet ports as either full- or half-duplex ports, at either 10 Mbps, 100 Mbps, 1000 Mbps or 10 Gigabit.

# FIREWALL

---

## Date & Time

- Date & Time Settings – sets the time zone and enables automatic time updates.
- Scheduler Rules Settings – limits the activation of firewall rules to specific time periods.

**DNS Settings** - manages the DNS server host name and IP address.

**Monitoring** - displays the details and status of:

- System Logging
- Full Status/System wide Monitoring of Connections/Traffic Monitoring
- Bandwidth Monitoring

**System Settings** - sets up various system and management parameters.

## 6.0/ FIREWALL

The firewall is the cornerstone of the security suite for your Verizon Router. It has been exclusively tailored to the needs of the residential or office user and is pre-configured to provide optimum security.

The firewall provides both the security and flexibility that home and office users seek. It provides a managed, professional level

of network security while enabling the safe use of interactive applications, such as internet gaming and video conferencing.

Additional features, including surfing restrictions and access control, can also be configured locally through the user interface or remotely by a service provider.

The firewall regulates the flow of data between the local network and the internet. Both incoming and outgoing data are inspected, then either accepted and allowed to pass through your Verizon Router or rejected and barred from passing through your Verizon Router, according to a flexible and configurable set of rules. These rules are designed to prevent unwanted intrusions from the outside, while allowing local network users access to internet services.

The firewall rules specify the type of services on the internet that are accessible from the local network and types of services in the local network that are accessible from the internet.

Each request for a service that the firewall receives is checked against the firewall rules to determine whether the request should be allowed to pass through the firewall. If the request is permitted to pass, all subsequent data associated with this request or session is also allowed to pass, regardless of its direction.

For example, when accessing a website on the internet, a request is sent to the internet for this site. When the request reaches your Verizon Router, the firewall identifies the request type and origin, such as HTTP and a specific computer in the local network. Unless your Verizon Router is configured to block requests of this type

# FIREWALL

---

from this computer, the firewall allows this type of request to pass to the internet.

When the website is returned from the web server, the firewall associates the website with this session and allows it to pass; regardless HTTP access from the internet to the local network is blocked or permitted. It is the origin of the request, not subsequent responses to this request, which determines whether a session can be established.

## 6.0a/ SETTING FIREWALL CONFIGURATION

You can select a normal, high, or low security level to limit, block, or permit all traffic. The following table shows request access for each security level.

Security Level	Internet Requests Incoming Traffic	Local Network Requests Outgoing Traffic
High	Blocked	Limited
Normal	Blocked	Unrestricted
Low	Unrestricted	Unrestricted

*The request access is defined as:*

- Blocked traffic - no access allowed, except as configured in Port Forwarding and Remote Access
- Limited - permits only commonly used services, such as email and web browsing



- Unrestricted - permits full access of incoming traffic from the internet and allows all outgoing traffic, except as configured in Access Control

## 6.0b/ SPECIFYING GENERAL SETTINGS FOR IPV4 OR IPV6

To set your firewall configuration:

1. From the Firewall **General** settings page, click on desired **IPv4 settings/IPv6 settings** option to configure IPv4/IPv6 security.

The screenshot displays the Verizon router's configuration interface. At the top, there are tabs for 'Basic' and 'Advanced', with 'Advanced' being the active tab. Below the tabs, the 'Network Device' is set to 'Verizon Router'. The main content area is titled 'Firewall > General' and includes an 'Apply Changes' button. The settings are organized into sections for 'IPv4 Settings' and 'IPv6 Settings'. Each section has three radio button options: 'Normal Security' (selected), 'High Security', and 'Low Security'. The 'High Security' option for IPv4 includes a toggle for 'Set Top Box traffic disabled' which is currently turned off. A left-hand navigation menu lists various settings categories: Home, Wi-Fi, Devices, Parental Controls, Status, Firewall (selected), Access Control, Port Forwarding, Port Triggering, DMZ Host, SIP ALG, Static NAT, IPv6 Pinholes, and Utilities.

# FIREWALL

---

2. Select a security level by clicking one of the radio buttons. Using the **Low Security** setting may expose the local network to significant security risks, and should only be used for short periods of time to allow temporary network access.
3. Click **Apply changes** to save changes.

## 6.0c/ ACCESS CONTROL

You can block individual computers on your local network from accessing specific services on the internet. For example, you could block one computer from accessing the internet, then block a second computer from transferring files using FTP as well as prohibit the computer from receiving incoming email.

Access control incorporates a list of preset services, such as applications and common port settings.

## ALLOW OR RESTRICT SERVICES

*To allow or restrict services:*

1. From the **Advanced** menu, select **Firewall** from the left pane and then click **Access Control**. The **Access Control** page opens with the **Allows** and **Blocked** sections displayed. The **Allowed** section only displays when the firewall is set to maximum security.

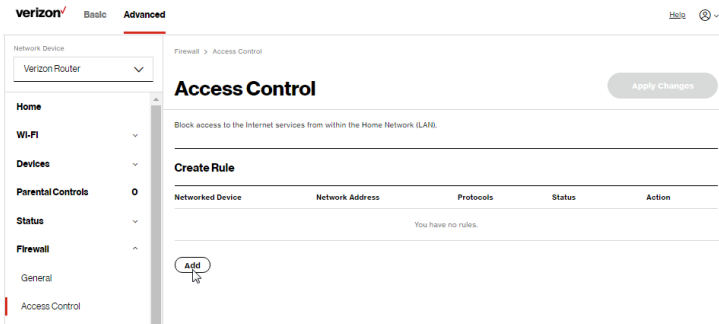

2. To block a service, click **Add**. The **Add Access Control** page displays.

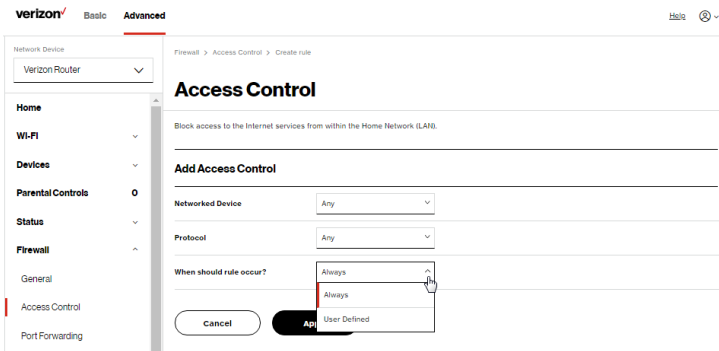

3. To apply the rule to:
  - Networked Computer/Device - select **Any**.
  - Specific devices only - select **User Defined**.

# FIREWALL

- In the Protocol field, select the internet protocol to be allowed or blocked. If the service is not included in the list, select **User Defined**. The **Edit Service** page displays. Define the service, then click **Apply**. The service is automatically added to the **Add Access Control** section.
- Specify when the rule is active as **Always** or **User Defined**.

The screenshot shows the Verizon router's web interface. At the top, there are tabs for 'Basic' and 'Advanced', with 'Advanced' selected. The breadcrumb trail reads 'Firewall > Access Control > Create rule'. The main heading is 'Access Control'. Below this, a sub-heading reads 'Block access to the Internet services from within the Home Network (LAN)'. The 'Set Rule Schedule' section contains the following fields: 'Rule name:' with an empty text box; 'Rule days:' with buttons for Sun, Mon, Tue, Wed, Thu, Fri, and Sat; 'Rule time:' with 'Start Time' set to 9:00 pm and 'End Time' set to 12:00 am. Below these fields are two radio button options: 'Rule will be active during scheduled time' (which is selected) and 'Rule will be inactive during scheduled time'. At the bottom of the form are 'Cancel' and 'Apply' buttons.

- Enter the rule name, specify days of the week, and set the start time and end time when the rule will be active or inactive.
- Click **Apply** to save changes.
- The **Access Control** page displays a summary of the new access control rule.

---

## DISABLE ACCESS CONTROL

You can disable an access control and enable access to the service without removing the service from the Access Control table. This can make the service available temporarily and allow you to easily reinstate the restriction later.

- To disable an access control, clear the check box next to the service name.
- To reinstate the restriction, select the check box next to the service name.
- To remove an access restriction, select the service and click **Remove**. The service is removed from the Access Control table.

## 6.0d/ PORT FORWARDING

You can activate port forwarding to expose the network to the internet in a limited and controlled manner. For example, enabling applications, such as gaming and voice, to work from the local network as well as allowing internet access to servers within the local network.

*To create port forwarding rules:*

1. From the **Advanced** menu, select **Firewall** from the left pane and then click **Port Forwarding**. The **Port Forwarding** page opens with the current rules displayed.

# FIREWALL

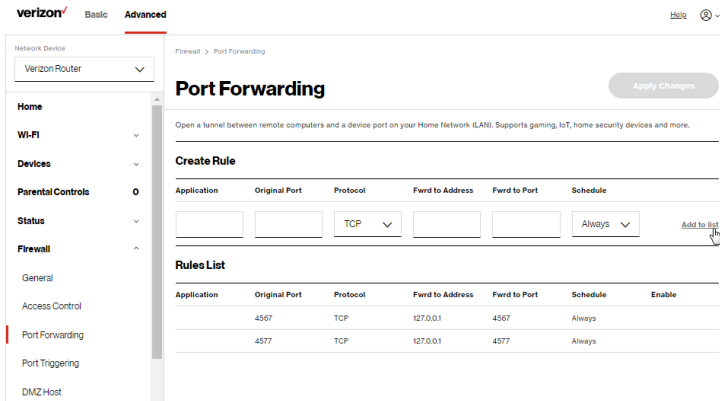

2. To create a new rule, enter the application name, configure its inbound and outbound port numbers, then select the protocol.
3. To schedule the rule, select either **Always** or **User Defined** in the **Schedule** list box.
4. Click **Add to list**. The rule displays in the **Rules List** section.
5. Click **Apply changes** to save changes.

## 6.0e/ PORT TRIGGERING

Port triggering can be described as dynamic port forwarding. By setting port triggering rules, inbound traffic arrives at a specific network host using ports that are different than those used for outbound traffic. The outbound traffic triggers the ports where the inbound traffic is directed.

For example, a gaming server is accessed using UDP protocol on port 2222. The gaming server then responds by connecting the user using UDP on port 3333, when a gaming session is initiated.

In this case, port triggering must be used since it conflicts with the following default firewall settings:

- Firewall blocks inbound traffic by default.
- Server replies to your Verizon Router IP, and the connection is not sent back to the host since it is not part of a session.

To resolve the conflict, a port triggering entry must be defined, which allows inbound traffic on UDP port 3333 only after a network host generated traffic to UDP port 2222. This results in your Verizon Router accepting the inbound traffic from the gaming server and sending it back to the network host which originated the outgoing traffic to UDP port 2222.

*To configure port triggering:*

1. From the **Advanced** menu, select **Firewall** and then click **Port Triggering**.

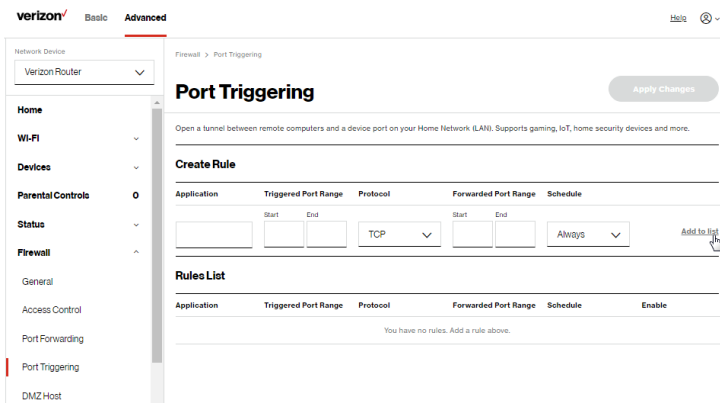

verizon Basic Advanced

Network Device  
Verizon Router

Home  
Wi-Fi  
Devices  
Parental Controls 0  
Status  
Firewall  
General  
Access Control  
Port Forwarding  
Port Triggering  
DMZ/Host

Firewall > Port Triggering

### Port Triggering

Apply Changes

Open a tunnel between remote computers and a device port on your Home Network (LAN). Supports gaming, IoT, home security devices and more.

#### Create Rule

Application	Triggered Port Range	Protocol	Forwarded Port Range	Schedule	
	Start	End	Start	End	
<input type="text"/>	<input type="text"/>	<input type="text"/>	<input type="text"/>	<input type="text"/>	<input type="text"/>
		TCP		Always	Add to list

#### Rules List

Application	Triggered Port Range	Protocol	Forwarded Port Range	Schedule	Enable
You have no rules. Add a rule above.					

# FIREWALL

---

2. To add a service as an active protocol, enter the application name, configure its inbound and outbound (triggered/forwarded) port range, then select the protocol.
3. To schedule the rule, select either **Always** or **User Defined** in the **Schedule** list box.
4. Click **Add to list**. The rule displays in the **Rules List** section.
5. Click **Apply changes** to save changes.

## 6.0f/ DMZ HOST

DMZ Host allows a single device on your primary network to be fully exposed to the internet for special purposes like internet gaming.

***Warning:** Enabling DMZ Host is a security risk. When a device on your network is a DMZ Host, it is directly exposed to the internet and loses much of the protection of the firewall. If it is compromised, it can also be used to attack other devices on your primary network.*

Follow these steps to designate a device on your primary network as a DMZ Host:

1. From the **Advanced** menu, select **Firewall** and then click **DMZ Host**.
2. Select **Enable** for the DMZ Host.
3. Enter the IP address or select the MAC address of the device you want to designate as the DMZ Host.
4. Click **Apply changes** to save changes.



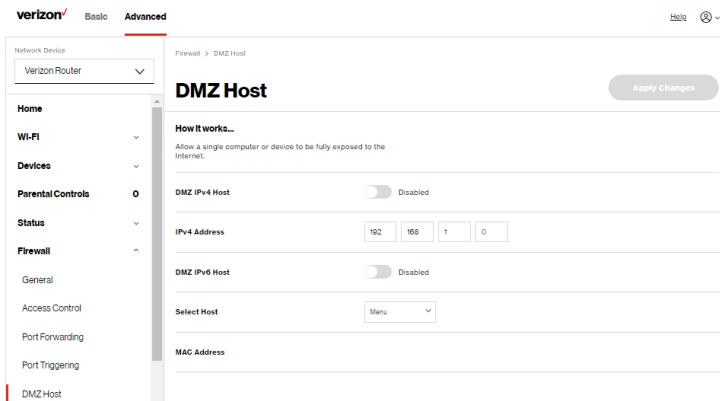

## 6.0g/ SIP ALG

SIP ALG (Application Level Gateway) - supports various multiple application protocols by allowing dynamic ephemeral TCP/ UDP ports to communicate with the known ports which a particular client application (such as FTP, VoIP service, net meeting or streaming media) requires.

*To enable the SIP ALG settings:*

1. From the **Advanced** menu, select **Firewall** and then click **SIP ALG**.
2. Move the selector to **on**
3. Click **Apply changes** to save changes.

# FIREWALL

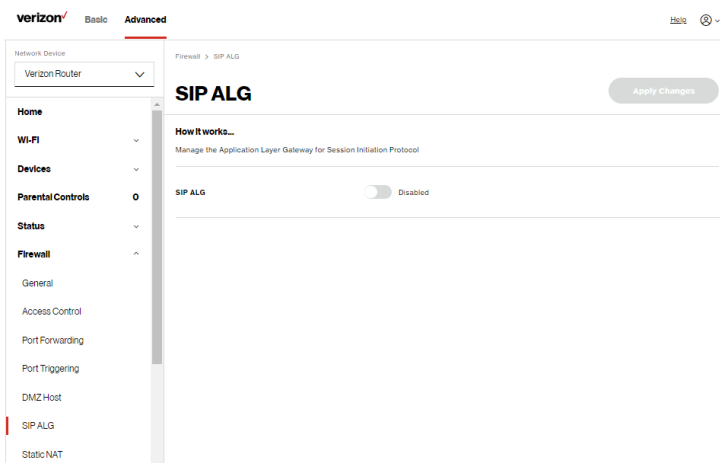

## 6.0h/ **STATIC NAT**

Static NAT allows devices located behind a firewall that is configured with private IP addresses to appear to have public IP addresses to the internet. This allows an internal host, such as a web server, to have an unregistered (private) IP address and still be accessible over the internet.

*To configure static NAT:*

1. From the **Advanced** menu, select **Firewall** and then click **Static NAT**.

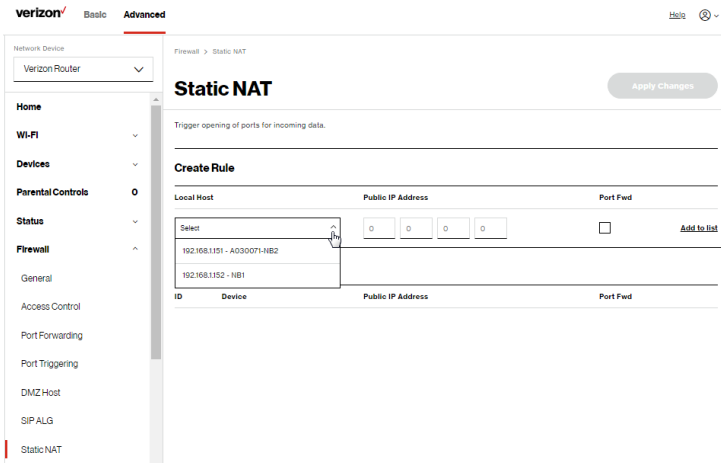

2. To create a static NAT, select a source address in the **Local Host** field.
3. Enter the **Public IP Address**.
4. If using port forwarding, select the **Port Fwd** check box.
5. Click **Add to list**. The rule displays in the **Rules List** section.
6. Click **Apply changes** to save changes.
7. Repeat these steps to add additional static IP addresses.

# FIREWALL

## 6.0i/ IPV6 PINHOLES

The IPv6 Pinhole feature of the Verizon Router allows an application to send incoming packets for a certain port number to the destination computer by setting up the rule of authorization.

*To configure the rules:*

1. From the **Advanced** menu, select **Firewall** and then click **IPv6 Pinhole**.

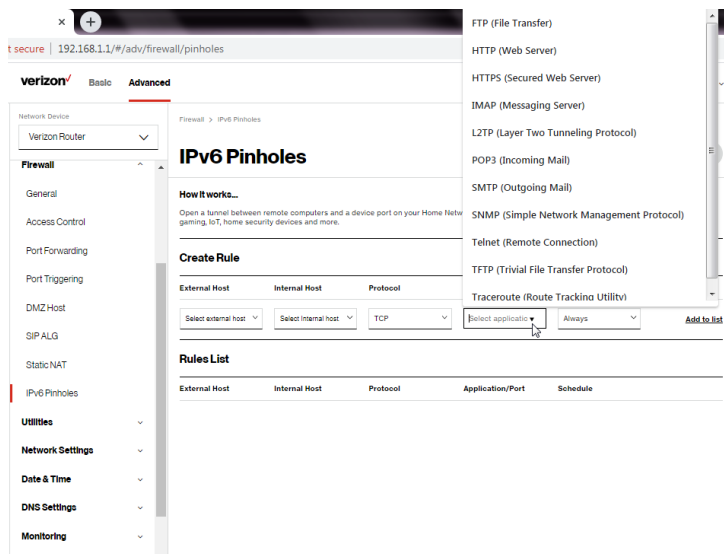

2. Select external and internal host, protocol and the application port type.
3. To schedule the rule, select either **Always** or **User Defined** in the **Schedule** list box.

4. Click **Add to list**. The screen displays opened pinhole port and its status. It shows the IP addresses of remote device and connected device on your network.
5. Click **Apply changes** to save changes.

## 6.1/ UTILITIES

You can access the following advanced settings:

- Diagnostics – performs diagnostic tests.
- Save and Restore – resets your Verizon Router to its default settings.
- Reboot Router – restarts your Verizon Router.
- MAC Cloning – clones the MAC address.
- ARP Table – displays active devices with their IP and MAC addresses.
- NDP (Neighbor Discovery Protocol) Table – displays active devices with their IPv6 and MAC addresses of DHCP connection.
- Users – creates and manages remote users.
- Remote Administration – enable remote configuration of your Verizon Router from any internet-accessible computer.
- LED Brightness - controls the Router Status LED light to either dim or brighten, and sets the dimming time of the LED light.

# UTILITIES

## 6.1a/ DIAGNOSTICS

You can use diagnostics to test network connectivity.

*To diagnose network connectivity:*

1. From the **Advanced** menu, select **Utilities**.
2. Select **Diagnostics** in the **Utilities** section.
3. To ping an IP address, enter the IP address or domain name in the **Destination** field and click **Go**.

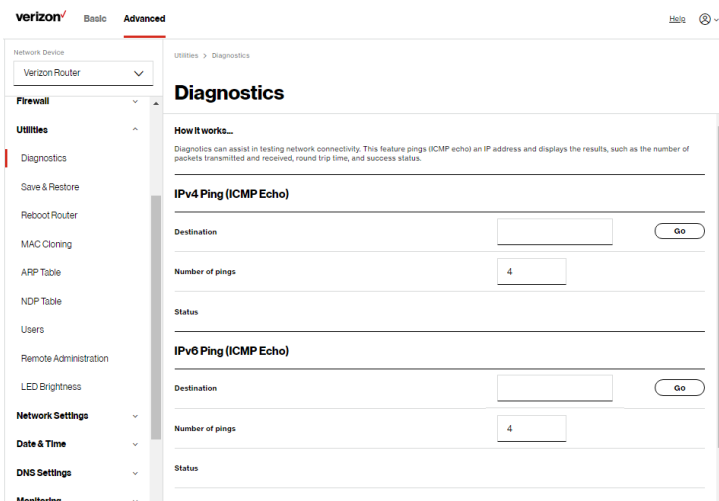

The diagnostics will display the number of pings, status, packets sent, and round trip time.

If no diagnostic status displays, click refresh in your web browser.

## 6.1b/ SAVE AND RESTORE

You can use this functionality to save and load configuration files. These files are used to backup and restore the current configuration of your Verizon Router.

Only configuration files saved on a specific Verizon Router can be applied to that Verizon Router. You cannot transfer configuration files between Verizon Routers.

**Warning:** Manually editing a configuration file can cause your Verizon Router to malfunction or become completely inoperable.

### Save Options

To save the configuration file:

1. Select **Save & Restore** in the **Utilities** section.

The screenshot shows the Verizon Router's web interface. At the top, there are tabs for 'Basic' and 'Advanced', with 'Advanced' selected. A 'Help' icon is visible in the top right. The left sidebar contains a navigation menu with categories: Network Device (Verizon Router), Firewall, Utilities (selected), Diagnostics, Save & Restore, Reboot Router, MAC Cloning, ARP Table, NDP Table, Users, Remote Administration, LED Brightness, Network Settings, Date & Time, DNS Settings, and Monitoring. The main content area is titled 'Save & Restore' and includes a 'Save & Restore' breadcrumb. Below the title is a 'How It Works...' section explaining that saving configuration allows for backup of custom settings like Wi-Fi names and passwords. The 'Save Options' section has a 'Save as configuration' button and two radio buttons: 'Save to router and your Verizon account' (selected) and 'Save as file'. The 'Restore Options' section has a 'Restore configuration' button and three radio buttons: 'Automated Backups (Set to "On" by default until disabled below)' (selected), 'Manual Backup', and 'Factory Default'. The 'Automated Backups' option has a 'Not Available' button and a checkbox for 'Disable & Delete Automated backups'. The 'Manual Backup' option also has a 'Not Available' button. The 'Factory Default' option has a 'Default Settings' dropdown menu. The 'Load a File' option has a 'Choose file' button.

# UTILITIES

---

2. Select **Save to router and your Verizon account** or **Save as file** to save the current configuration, then click **Save as configuration**.
3. If you select **Save as file**, the configuration file is saved to your web browser's download folder.

## Restore Options

You can restore your configuration settings to your Verizon Router factory default settings. Restoring the default settings erases the current configuration, including user defined settings and network connections. All connected DHCP clients must request new IP addresses. Your Verizon Router must restart.

Prior to restoring the factory defaults, you may want to save your current configuration to a file. This allows you to reapply your current settings and parameters to the default settings, as needed.

*Note: When restoring defaults, the setting and parameters of your Verizon Router are restored to their default values. This includes the administrator password. A user-specified password will no longer be valid.*

*To backup your Verizon Router's settings:*

1. Select **Save & Restore** in the **Utilities** section.
2. To take a backup of the current settings, click **Automated Backups** or **Manual Backup**. You will be prompted to save a file with the extension ".enc".
3. Click **Backup** to begin the configuration backup process.



To restore your Verizon Router's factory default settings:

1. Select **Save & Restore** in the **Utilities** section.
2. Click **Factory Defaults**.

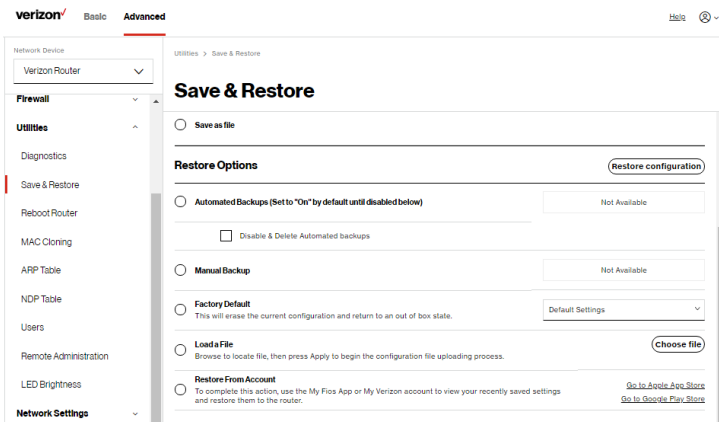

- **Default Settings** – will erase all router settings including user settings for SSID and Passwords.
  - **Default Settings except current user settings** – will erase all router settings but will retain the user settings for SSID and passwords.
3. Click **Restore configuration** button. The factory default settings are applied and your Verizon Router restarts. Once complete, the Login page for the First Time Easy Setup Wizard displays.

# UTILITIES

---

*To load the configuration file:*

1. Select **Save & Restore** in the **Utilities** section.
2. To load a previously saved configuration file, click **choose file**.
3. Browse to the location of the file, and click **Restore configuration** button to begin the configuration uploading process.
4. Accessing the Verizon app or the **My Verizon** account also allows you to restore the previously saved settings. Click **Restore From Account** and select **Go to Apple App Store/ Go to Google Play Store** to restore the saved settings to the router.
5. Click **Restore configuration** button. Your Verizon Router will automatically restart with that configuration.

## **6.1c/ REBOOT VERIZON ROUTER**

*Warning: Only select Reboot Router if instructed to do so by Verizon support.*

You can reboot your Verizon Router using the Reboot Router Only feature. Refer to 1.3b/ REAR PANEL for power button options.

*To reboot your Verizon Router using the user interface:*

1. Select **Reboot Router** in the **Utilities** section.

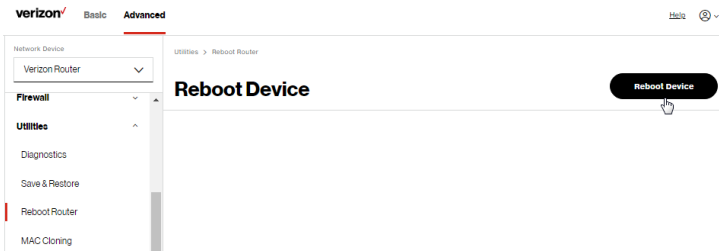

2. To reboot, click **Reboot Device**. Your router will reboot. This may take up to a minute.
3. To access your Verizon Router user interface, refresh your web browser.
4. After the Router Status LED on the front panel turns solid white, you will automatically be sent to the web browser login page.

## 6.1d/ MAC CLONING

A MAC address is a hexadecimal code that identifies a device on a network. All networkable devices have a unique MAC address.

When replacing a network device on your Verizon Router, you can simplify the installation process by copying the MAC address of the existing device to your Verizon Router.

*To copy the MAC address of the existing device:*

1. Select **MAC Cloning** in the **Utilities** section.

# UTILITIES

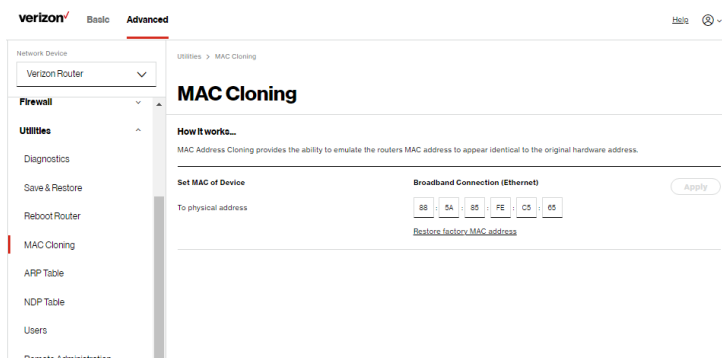

2. In the **To physical address** field, enter the MAC address of your new device.
3. To locate the MAC address, refer to the documentation from the device manufacturer.
4. Click **Apply** to save changes.

## 6.1e/ ARP TABLE

You can view the IPv4 and MAC addresses of each DHCP connection.

*To view the IPv4 and MAC addresses for each device: select **ARP Table** in the **Utilities** section.*

The screenshot shows the Verizon router's web interface. The top navigation bar includes the Verizon logo, 'Basic', and 'Advanced' tabs. The left sidebar lists various utility options: Firewall, Utilities, Diagnostics, Save & Restore, Reboot Router, MAC Cloning, ARP Table (highlighted), and NDP Table. The main content area is titled 'ARP Table' and includes a 'Refresh' button. Below the title, a text description states: 'The ARP Table below displays the IPv4 and MAC address of each DHCP connection.' A table follows with the following data:

IPv4 Address	MAC Address	State	Device
192.168.1.254	-	FAILED	Network (Home/Office)
192.168.1.152	48:5b:39:41:56:08	REACHABLE	Network (Home/Office)
192.168.1.101	14:69:42:f1:a7:93	REACHABLE	Network (Home/Office)

## 6.1f/ NDP TABLE

You can view the IPv6 and MAC addresses of each DHCP connection.

*To view the IPv6 and MAC addresses for each device: select **NDP** (Neighbor Discovery Protocol ) **Table** in the **Utilities** section.*

The screenshot shows the Verizon router's web interface with the 'NDP Table' utility selected. The left sidebar highlights 'NDP Table' under the 'Utilities' section. The main content area is titled 'NDP Table' and includes a 'Refresh' button. Below the title, a text description states: 'The NDP Table below displays the IPv6 and MAC address of each DHCP connection.' A table follows with the following data:

IPv6 Address	MAC Address	State	Rtr	Device
fd00:1ff6:2963:019:9157	48:5b:39:41:56:08	REACHABLE	No	Network (Home/Office)

# UTILITIES

## 6.1g/ USERS

You can view the users that can currently access your Wi-Fi network. In addition, you can modify their login password and name as well as manage the number of unsuccessful login attempts a user can enter before your Verizon Router temporarily denies all further login attempts by that user.

*To view users:*

1. Select **Users** in the **Utilities** section.

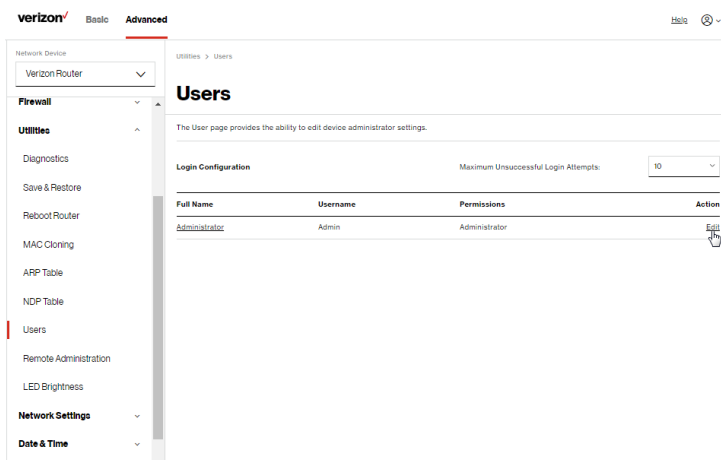

2. In the **Login Configuration** section, enter the maximum number of unsuccessful login attempts.
3. To edit usernames and passwords, click the **Edit** in the **Action** column. The **Edit User Settings** page displays.

Network Device  
Verizon Router

Utilities > Users > Edit User Settings

### Edit User Settings

Apply Changes

Full name	<input type="text" value="Administrator"/>
User name	<input type="text" value="Admin"/>
Permissions	<input type="text" value="Administrator"/>
Set new password	<input type="password"/> minimum 8 characters
Retype new password	<input type="password"/>

4. Edit the Full name, User name and set a new password.
5. To add a new user, specify the following parameters:
  - **Full Name** - name of the user.
  - **User Name** – name the user enters to remotely access the home or office network. This field is case-sensitive.
6. Verify the level of access for the user in the **Permissions** field.
7. Click **Apply changes** to save changes. The **Users** page opens with the user information displayed.

# UTILITIES

---

## 6.1h/ REMOTE ADMINISTRATION

*Caution: Enabling Remote Administration places your Verizon Router network at risk from outside attacks.*

You can access and control your Verizon Router not only from within the local network, but also from the internet using **Remote Administration**.

*You can allow incoming access to the following:*

- **Allow incoming WAN Access to Web Management** - used to obtain access to your Verizon Router's UI and gain access to all settings and parameters through a web browser.
- **Diagnostic Tools** - used for troubleshooting and remote system management by a user or Verizon.

Web Management remote administration access may be used to modify or disable firewall settings. Web Management services should be activated only when absolutely necessary.

*To enable remote administration:*

1. Select **Remote Administration**.



The screenshot shows the Verizon router's web interface. The top navigation bar includes the Verizon logo, 'Basic', and 'Advanced' tabs. The left sidebar lists various settings categories: Firewall, Utilities, Diagnostics, Save & Restore, Reboot Router, MAC Cloning, ARP Table, NDP Table, Users, Remote Administration (highlighted), LED Brightness, and Network Settings. The main content area is titled 'Remote Administration' and contains the following sections:

- Remote Administration**: A heading with an 'Apply Changes' button.
- Configure Remote Administration to the router**: A sub-heading.
- Attention**: A warning that says 'With Remote Administration enabled, your local network will be at risk from outside attacks'.
- Allow Incoming WAN Access to Web-Management**: A section with a 'system settings' button and a checkbox for 'Using Primary HTTPS Port (443)'.
- Diagnostic Tools**: A section with two checkboxes: 'Allow Incoming WAN ICMP Echo Requests (e.g. pings and ICMP traceroute queries)' (checked) and 'Allow Incoming WAN UDP Traceroute Queries'.

2. To enable access, select the check box.
3. To remove access, clear the check box.
4. Click **Apply changes** to save changes.

# UTILITIES

## 6.1i/ LED BRIGHTNESS

The Verizon Router allows you to set the LED brightness to turn Off (0%) or stay bright (50% or 100%) using the user interface.

*To control the LED brightness:*

1. Select **LED Brightness** in the **Utilities** section.

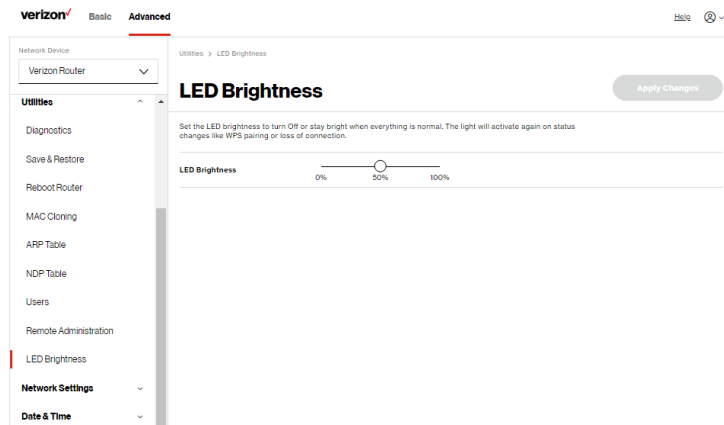

2. Slide the bar to adjust the brightness of the LED.
3. Click **Apply changes** to save changes.

**Note:** *The light will activate again on status changes like WPS pairing or loss of connection.*

---

## 6.2/ NETWORK SETTINGS

You can configure the following network settings:

- **Network Objects** – defines a group, such as a group of computers.
- **Network Connections** – displays and manages the details of a specific network connection.
- **Universal Plug and Play (UPnP)** – checks the validity of all UPnP services and rules.
- **Port Forwarding Rules** – displays port forwarding rules.
- **IPv6** – enables IPv6 support.
- **Routing** – manages the routing and IP address distribution rules.
- **IPv4/IPv6 Address Distribution** - adds computers configured as DHCP clients to the network.
- **Port Configuration** – sets up the Ethernet ports as either full- or half-duplex ports, at either 10 Mbps, 100 Mbps, or 1000 Mbps.

### 6.2a/ NETWORK OBJECTS

Network objects define a group, such as a group of computers, on your Verizon Router network by MAC address, IP address, and/or host name. The defined group becomes a network object. You can apply settings, such as configuring system rules, to all devices defined in the network object.

# NETWORK SETTINGS

For example, instead of setting the same website filtering configuration individually to five computers one at a time, you can define the computers as a network object. Website filtering can then be simultaneously applied to all the computers.

You can use network objects to apply security rules based on host names, instead of IP addresses. This is useful since IP addresses change from time to time. In addition, you can define network objects according to MAC address to make the rule application more persistent against network configuration settings.

*To define a network object:*

1. From the **Advanced** menu, select **Network Settings**.
2. Select **Network Objects** in the **Network Settings** section.

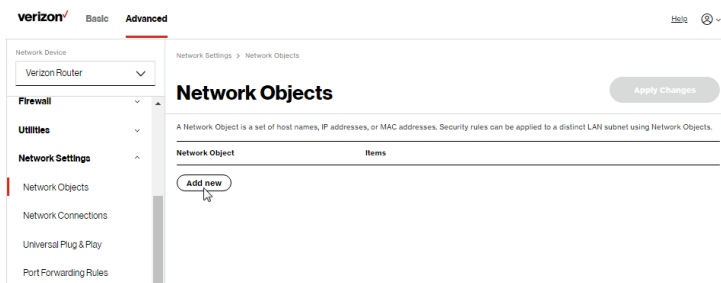

3. To define a network object, click **Add new**. The **Edit Network Objects** page displays.

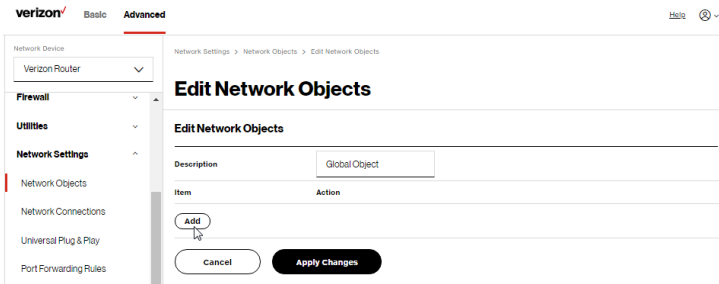

4. In the **Description** field, enter a name for the network object.
5. Click **Add**. The **Edit Item** page displays.

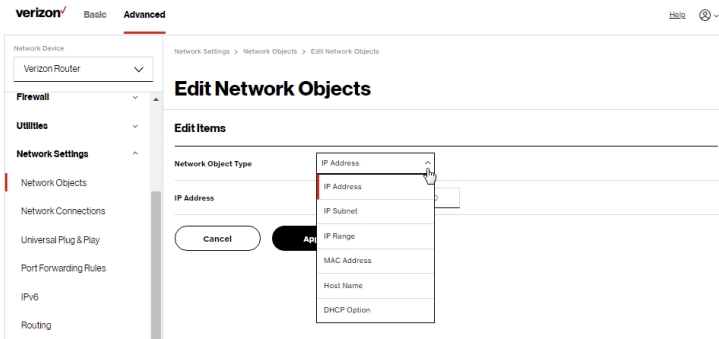

6. Select and configure the type of network object as IP address, IP subnet, IP range, MAC address, host name, or DHCP option, and click **Apply** to save changes.
7. Repeat the above steps to create additional network objects.
8. When complete, click **Apply changes** to save changes.

# NETWORK SETTINGS

## 6.2b/ NETWORK CONNECTIONS

**Caution:** The settings described in this chapter should only be configured by experienced network technicians. Changes could adversely affect the operation of your router and your local network.

To view the network connections:

1. From the **Advanced** menu, select **Network Settings** from the left pane and then click **Network Connections**.

The screenshot shows the Verizon router's web interface. The top navigation bar includes 'verizon', 'Basic', and 'Advanced' (selected), along with a 'Help' icon. The left sidebar lists various settings: 'Network Device' (Verizon Router), 'Firewall', 'Utilities', 'Network Settings' (selected), 'Network Objects', 'Network Connections', 'Universal Plug & Play', 'Port Forwarding Rules', 'IPv6', and 'Routing'. The main content area is titled 'Network Connections' and contains a table with the following data:

Network name	Status	
<a href="#">Network (Home/Office)</a>	Connected	<a href="#">Edit</a>
<a href="#">5 GHz Wi-Fi Access Point</a>	Disconnected	<a href="#">Edit</a>
<a href="#">6 GHz Wi-Fi Access Point</a>	Disconnected	<a href="#">Edit</a>
<a href="#">2.4 GHz Wi-Fi Access Point</a>	Disconnected	<a href="#">Edit</a>
<a href="#">Ethernet</a>	Connected	<a href="#">Edit</a>
<a href="#">Coax</a>	Cable Disconnected	<a href="#">Edit</a>
<a href="#">Broadband Connection (Ethernet)</a>	Disconnected	<a href="#">Edit</a>

At the bottom of the table area is a button labeled 'Full Status'.

2. To view and edit the details of a specific network connection, click the hyperlinked name or the action icon. The following sections detail the types of network connections that you can view.

## NETWORK (HOME/OFFICE) CONNECTION

You can view the properties of your local network. This connection is used to combine several network interfaces under one virtual network. For example, you can create a home/office network connection for Ethernet and other network devices.

*Note: When a network connection is disabled, the underlying devices formerly connected to it will not be able to obtain a new DHCP address from that Verizon Router network interface.*

To view the connection:

1. On the **Network Connections** page, click the **Network (Home/Office)** connection link. The **Network (Home/ Office) Properties** page displays.

The screenshot shows the Verizon Network (Home/Office) Properties page. The page is titled "Network (Home/Office)" and has a "settings" button and a "Save" button. The page displays the following information:

- Network Device:** Verizon Router
- Network Settings:** Network Connections
- Network (Home/Office) Properties:**
  - Name:** Network (Home/Office)
  - Status:** Connected
  - Network:** Network (Home/Office)
  - Underlying Device:** 2.4 GHz Wi-Fi Access Point, 5 GHz Wi-Fi Access Point, 2.4 GHz Wi-Fi Access Point, Ethernet, USB
  - Connection Type:** Bridge
  - MAC Address:** 88:5A:85:FE:C5:66
  - IP4 Address:** 192.168.1.1

# NETWORK SETTINGS

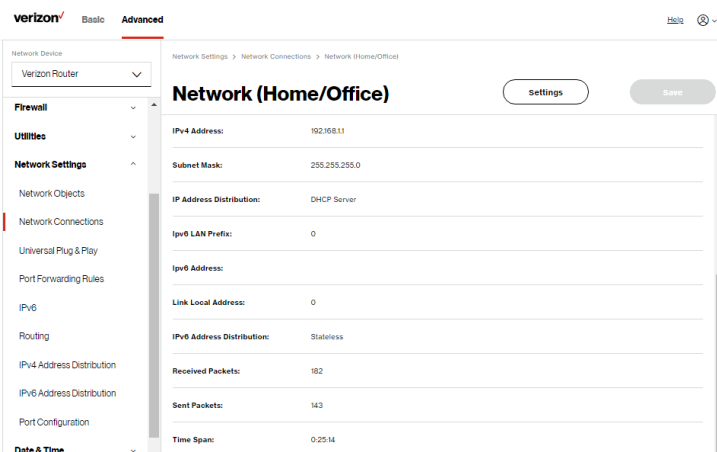

2. To rename a network connection, enter the new network name in the **Name** field.
3. Click **Save** to save the changes.

## CONFIGURING THE HOME/OFFICE NETWORK

*To configure the network connection:*

1. In the **Network (Home/Office) Properties** page, click **Settings**. The configuration page displays.



verizon Basic **Advanced** Help ⓘ

Network Device  
Verizon Router

Network Settings > Network Connections > Network (Home/Office)

## Network (Home/Office) Save Changes

Important: Only advanced technical users should use this feature.

### General

Status: Connected

Connection Type: Network (Home/Office)

Physical Address: 88:5A:85:FE:C5:66

MTU: Automatic 1500

Internet Protocol: Use the Followin...

IP Address: 192 168 1 1

Subnet Mask: 255 255 255 0

### Bridge

Name	VLAN	Status
<input type="checkbox"/> Broadband Connection (Ethernet) Disable Disconnected Edit		
<input checked="" type="checkbox"/> 5 GHz Wi-Fi Access Point Disable Disconnected Edit		
<input checked="" type="checkbox"/> 6 GHz Wi-Fi Access Point Disable Disconnected Edit		
<input checked="" type="checkbox"/> 2.4 GHz Wi-Fi Access Point Disable Disconnected Edit		
<input checked="" type="checkbox"/> Ethernet Disable Connected Edit		
<input checked="" type="checkbox"/> Coax Disable Disabled Edit		

verizon Basic **Advanced** Help ⓘ

Network Device  
Verizon Router

Network Settings > Network Connections > Network (Home/Office)

## Network (Home/Office) Save Changes

### Bridge

Name	VLAN	Status
<input type="checkbox"/> Broadband Connection (Ethernet) Disable Disconnected Edit		
<input checked="" type="checkbox"/> 5 GHz Wi-Fi Access Point Disable Disconnected Edit		
<input checked="" type="checkbox"/> 6 GHz Wi-Fi Access Point Disable Disconnected Edit		
<input checked="" type="checkbox"/> 2.4 GHz Wi-Fi Access Point Disable Disconnected Edit		
<input checked="" type="checkbox"/> Ethernet Disable Connected Edit		
<input checked="" type="checkbox"/> Coax Disable Disabled Edit		

IP Address Distribution: DHCP Server

Start IP Address: 192 168 1 2

End IP Address: 192 168 1 254

WINS Server: 0 0 0 0

# NETWORK SETTINGS

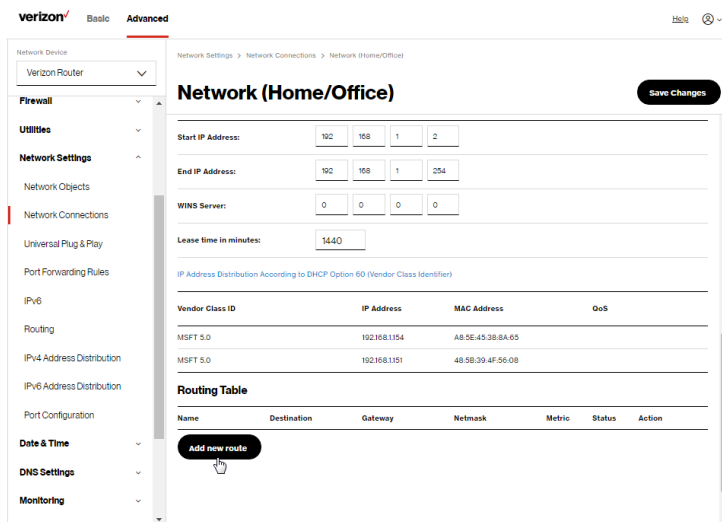

2. Configure the following sections, as needed.

## General

In the **General** section, verify the following information:

- **Status** - displays the IP connection status of the network.
- **Connection Type** - displays the type of connection interface.
- **Physical Address** - displays the physical address of the network card used for the network.
- **MTU** - displays the Maximum Transmission Unit (MTU) indicating the largest packet size permitted for internet transmissions:

- 
- **Automatic:** sets the MTU (Maximum Transmission Unit) at 1500.
  - **Automatic by DHCP:** sets the MTU according to the DHCP connection.
  - **Manual:** allows you to manually set the MTU.
  - **Internet Protocol**

In the Internet Protocol section, specify one of the following:

    - **No IPv4 Address:** the connection has no IP address. This is useful if the connection operates under a bridge.
    - **Obtain an IPv4 Address Automatically:** the network connection is required by Verizon to obtain an IP address automatically. The server assigning the IP address also assigns a subnet mask address, which can be overridden by entering another subnet mask address.
    - **Use the Following IP Address:** the network connection uses a permanent or static **IP address** and **Subnet Mask** address, provided by Verizon or experienced network technician.

# NETWORK SETTINGS

---

## Bridge

In the **Bridge** section of the **Network (Home/Office) Properties**, you can configure the various LAN interfaces.

***Caution:** Do not change these settings unless specifically instructed to by Verizon. Changes could adversely affect the operation of your Verizon Router and your local network.*

Verify the following information:

- **Status** – displays the connection status of a specific network connection.
- **Action** – contains an **Edit** hyperlink that, when clicked, generates the next level configuration page for the specific network connection or network device.

## IP Address Distribution

The **IP Address Distribution** section is used to configure the Dynamic Host Configuration Protocol (DHCP) server parameters of your Verizon Router.

Once enabled and configured, the DHCP server automatically assigns IP addresses to any network devices which are set to obtain their IP address dynamically.

If DHCP Server is enabled on your Verizon Router, configure the network devices as DHCP Clients. There are 2 basic options in this section: **Disabled** and **DHCP Server**.

*To set up the Verizon Router's network bridge to function as a DHCP server:*

1. In the **IP Address Distribution** section, select the **DHCP server**. Once enabled, the DHCP server provides automatic IP assignments (also referred to as IP leases) based on the preset IP range defined below.
  - **Start IP Address** – Enter the first IP address in the IP range that the Verizon Router will automatically begin assigning IP addresses from. Since your Verizon Router's IP address is 192.168.1.1, the default Start IP Address is 192.168.1.2.
  - **End IP Address** – Enter the last IP address in the IP range that the Verizon Router will automatically stop the IP address allocation at. The maximum end IP address range that can be entered is 192.168.1.254.
2. If Windows Internet Naming Service (WINS) is being used, enter the **WINS Server** address.
3. In the **Lease Time in Minutes** field, enter the amount of time a network device is allowed to connect to the Verizon Router with its currently issued dynamic IP address.

# NETWORK SETTINGS

---

## **IP Address Distribution According to DHCP option 60 (vendor class Identifier)**

DHCP vendor class is related to DHCP option 60 configuration within the router. Adding option 60 configurations allows a particular vendor to get a lease from a specified pool of addresses..

Click **Save Changes** to save changes.

## **Routing Table**

You can configure your Verizon Router to use static or dynamic routing.

- **Static routing** – specifies a fixed routing path to neighboring destinations based on predetermined metrics.
- **Dynamic routing** – automatically adjusts how packets travel on the network. The path determination is based on network/ device reachability and the status of the network being traveled.

*To configure routing:*

1. In the **Routing Table** section, click **Add new route** button to display and modify the new route configuration page.

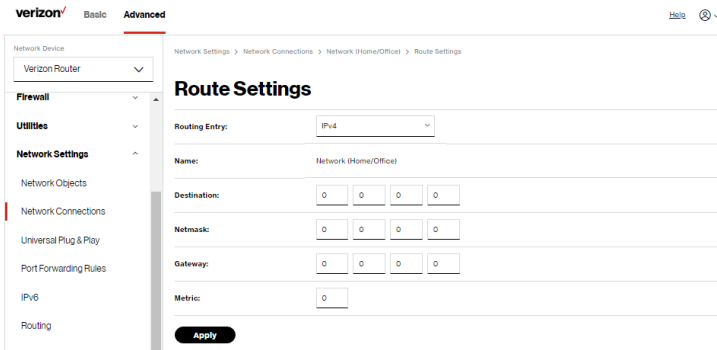

2. To save your changes click **Apply**.

## WI-FI ACCESS POINT CONNECTION

A Wi-Fi Access Point network connection allows Wi-Fi devices to connect to the local area network (LAN) using the 2.4 GHz, 5 GHz or 6 GHz Wi-Fi network.

*Note: Once disabled, all Wi-Fi devices connected to that Wi-Fi network will be disconnected from the LAN network and internet.*

To view the connection settings:

1. From the **Advanced** menu, select **Network Settings** from the left pane and then click **Network Connections**.
2. On the **Network Connections** page, click the **Network (Home/Office)** connection link. The **Network (Home/Office) Properties** page displays.

# NETWORK SETTINGS

3. To access the connection settings pages, click on the link of any of the connections listed under **Network name**.

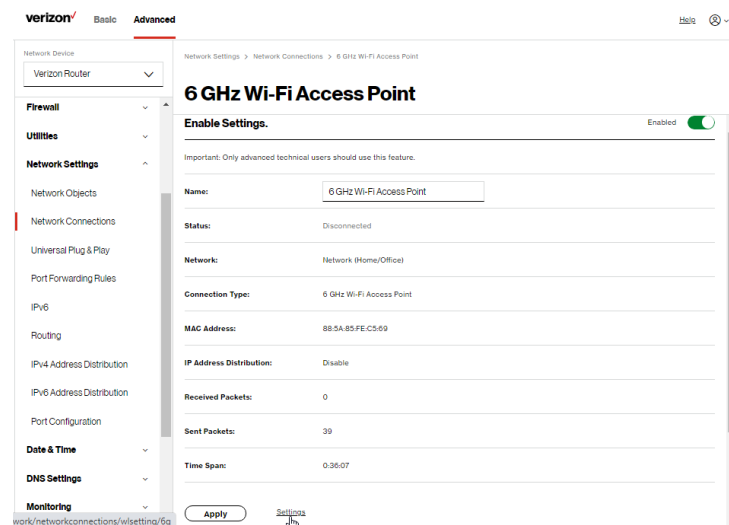

4. From the connection's **Enable Settings** page, to enable or disable the connection, move the selector to **on** or **off**.
5. To rename the connection, to enter a name in the **Name** field.
6. Click **Apply** to save the changes.
7. Reboot your Verizon Router.

## CONFIGURING WI-FI ACCESS POINT PROPERTIES

*To configure the connection:*

1. On the bottom of the Access Points specific **Enable Settings** page, click **Settings**. The configuration page displays.



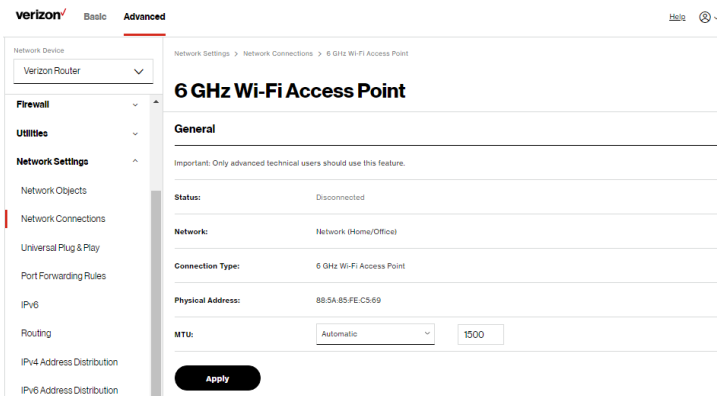

2. Verify the following information:
  - **Status** - displays the connection status of the network.
  - **Network** – displays the type of network connection.
  - **Connection Type** - displays the type of connection interface.
  - **Physical Address** - displays the physical address of the network card used for the network.
  - **MTU** - specifies the largest packet size permitted for internet transmissions:
    - **Automatic:** set the MTU (Maximum Transmission Unit) at 1500.
    - **Automatic by DHCP:** sets the MTU according to the DHCP connection.
    - **Manual:** allows you to manually set the MTU.
3. Click **Apply** to save changes.

# NETWORK SETTINGS

## ETHERNET CONNECTION

You can view the properties of your Ethernet LAN connection using an Ethernet cable inserted into one of your Verizon Router's Ethernet LAN ports.

*To view the connection settings:*

1. In the **Network Connections** page, click the **Network(Home/Office)** connection link.
2. Next, to access the **Ethernet** properties page, click the **Ethernet** link listed under the **Underlying Device** section.

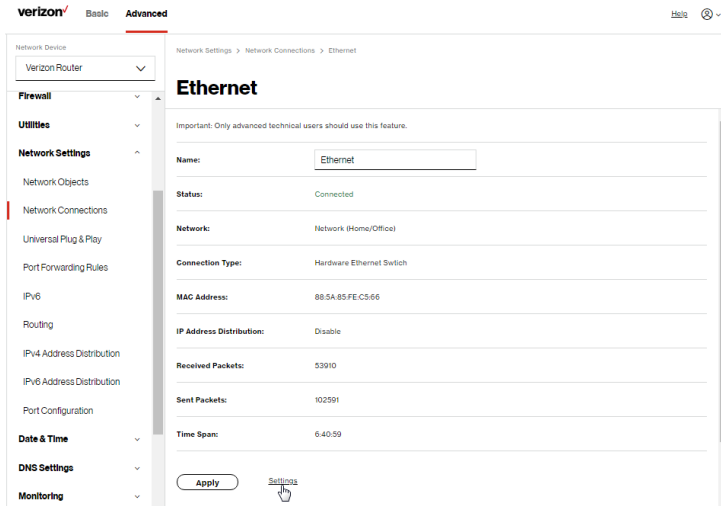

3. To rename the network connection, enter the new name in the **Name** field.
4. Click **Apply** to save changes.

## CONFIGURING ETHERNET PROPERTIES

To configure the connection:

1. In the **Ethernet** page, click **Settings**. The configuration page displays.

The screenshot shows the Verizon Advanced Network Settings interface. The left sidebar contains a navigation menu with categories: Firewall, Utilities, Network Settings (selected), Network Objects, Network Connections, Universal Plug & Play, Port Forwarding Rules, IPv6, Routing, IPv4 Address Distribution, IPv6 Address Distribution, Port Configuration, Date & Time, DNS Settings, and Monitoring. The main content area is titled "Ethernet" and is divided into "General" and "HW Switch Ports" sections. The "General" section includes a warning, "Status: Connected", "Network: Network (Home/Office)", "Connection Type: Hardware Ethernet Switch", and "Physical Address: 88:5A:85:FE:C3:66". The "MTU" is set to "Automatic" with a value of "1500". The "HW Switch Ports" section shows a table of ports:

Port	Status
LAN 10GE	Disconnected
LAN Port 1	Connected 100 Mbps Full-Duplex
LAN Port 2	Disconnected

2. Configure the following settings, as needed.

### General

Verify the following information:

- **Status** - displays the connection status of the network.
- **Network** – displays the type of network connection.
- **Connection Type** - displays as **Hardware Ethernet Switch**.

# NETWORK SETTINGS

- **Physical Address** - displays the physical address of the network card used for the network.
  - **MTU** - specifies the largest packet size permitted for
    - **Automatic:** sets the MTU (Maximum Transmission Unit at 1500).
    - **Automatic by DHCP:** sets the MTU according to the DHCP connection.
    - **Manual:** allows you to manually set the MTU.
  - **HW Switch Ports** - displays the status of each LAN port.
3. Click **Apply** to save the changes.

## COAX

The screenshot shows the Verizon network settings interface. The left sidebar contains a navigation menu with categories: Firewall, Utilities, Network Settings (expanded), Network Objects, Network Connections, Universal Plug & Play, Port Forwarding Rules, IPv6, Routing, IPv4 Address Distribution, IPv6 Address Distribution, Port Configuration, Date & Time, DNS Settings, and Monitoring. The main content area is titled "Coax" and includes an "Enable Settings" toggle (currently turned on). Below this, a warning states: "Important: Only advanced technical users should use this feature." The settings table is as follows:

Field	Value
Name	Coax
Status	Cable Disconnected
Network	Network (Home/Office)
Connection Type	Hardware MoCA
MAC Address	88:5A:85:FE:C3:66
IP Address Distribution	Disable
Received Packets	0
Sent Packets	0
Time Span	0:00:00

At the bottom of the settings area, there is an "Apply" button and a "Settings" link with a mouse cursor pointing to it. The URL in the browser address bar is "work/networkconnections/coaxsettings".

To view the connection settings:

1. In the **Network Connections** page, click the **Coax** link.
2. From the connection's **Enable Settings** page, to enable or disable the connection, move the selector to **on** or **off**.
3. To rename the network connection, enter the new name in the **Name** field.
4. Click **Apply** to save changes.

## CONFIGURING COAX PROPERTIES

To configure the connection:

1. In the **Coax** page, click **Settings**. The configuration page displays.

The screenshot shows the Verizon router configuration interface. At the top, there are tabs for 'Basic' and 'Advanced', with 'Advanced' selected. The breadcrumb trail reads 'Network Settings > Network Connections > Coax'. The main heading is 'Coax'. Below this, there is a 'General' section with a warning: 'Important: Only advanced technical users should use this feature.' The settings are as follows:

Status:	Cable Disconnected
Network:	Network (Home/Office)
Connection Type:	Hardware MoCA
Physical Address:	88:5A:85:FE:C5:66
MTU:	Automatic (dropdown) 1500 (input)

Below the 'General' section is the 'Coax Link' section:

Privacy:	Enable <input type="checkbox"/>
Password:	9999999998888888 (input)
Coax Connection Stats:	<a href="#">Go to LAN Coax Stats</a>

At the bottom of the configuration area is an 'Apply' button.

# NETWORK SETTINGS

---

2. Configure the following settings, as needed.

## General

Verify the following information:

- **Status** - displays the connection status of the network.
- **Network** – displays the type of network connection.
- **Connection Type** - displays the type of connection interface.
- **Physical Address** - displays the physical address of the network card used for the network.
- **MTU** - specifies the largest packet size permitted for internet transmissions:
  - **Automatic:** sets the MTU (Maximum Transmission Unit at 1500).

## Coax Link

- **Privacy** - to set **Privacy**, select the **Enabled** check box. This causes all devices connected to the coaxial cable to use the same password. This is recommended. To set the password, enter the Coax Link password in the **Manual entry of privacy password** field.
- To enable or disable the Coax link, click **Enable** or **Disable**.
- To view the devices connected using the coaxial cable, click the **Go to LAN Coax Status** link.

3. Click **Apply** to save changes.

## BROADBAND CONNECTION (ETHERNET)

You can view the properties of your broadband connection (your connection to the internet). This connection may be via Ethernet cable.

*To view the connection settings:*

1. In the **Network Connections** page, click the **Broadband Connection (Ethernet)** link.

The screenshot shows the Verizon router's web interface. At the top, there are tabs for 'Basic' and 'Advanced', with 'Advanced' selected. The breadcrumb trail reads 'Network Settings > Network Connections > Broadband Connection (Ethernet)'. The main heading is 'Broadband Connection (Ethernet)'. Below this, there is a toggle switch for 'Enable Settings.' which is turned on. A warning message states: 'Important: Only advanced technical users should use this feature.' The settings are as follows:

Name:	Broadband Connection (Ethernet)
Status:	Disconnected
Network:	Broadband Connection
Connection Type:	Disconnected
MAC Address:	
IPv4 WAN Address:	
Subnet Mask:	
Default Gateway:	
IPv4 DNS Address 1:	
IPv4 DNS Address 2:	

The left sidebar contains a navigation menu with categories: Firewall, Utilities, Network Settings (expanded), Date & Time, DNS Settings, and Monitoring. Under Network Settings, 'Network Connections' is highlighted.

# NETWORK SETTINGS

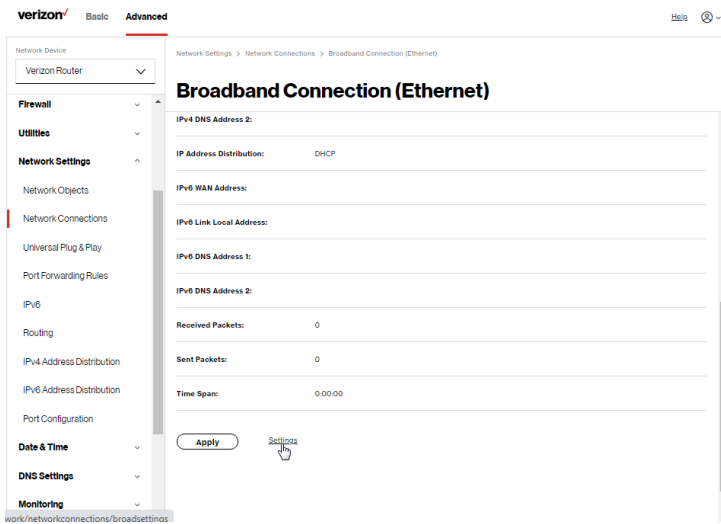

## CONFIGURING BROADBAND CONNECTION

*To configure the connection:*

1. In the **Broadband Connection (Ethernet) Properties** page, click **Settings**. The configuration page displays.



verizon Basic **Advanced** Help

Network Device  
Verizon Router

**Firewall**

**Utilities**

**Network Settings**

- Network Objects
- Network Connections
- Universal Plug & Play
- Port Forwarding Rules
- IPv6
- Routing
- IPv4 Address Distribution
- IPv6 Address Distribution
- Port Configuration

**Date & Time**

**DNS Settings**

**Monitoring**

### Broadband Connection (Ethernet) Settings

Network Settings > Network Connections > Network Connection Broadband Settings

**General**

Important: Only advanced technical users should use this feature.

Status: Disconnected

Network: Broadband Connection (Ethernet)

Connection Type:

Physical Address:

MTU: Automatic 1500

**WAN IP Address**

Internet Protocol: Obtain IPv4 Address Automatically

Override Subnet Mask: No IPv4 Address

DHCP Lease: Obtain IPv4 Address Automatically

Expires In: Use the following IPv4 Address

Expires In: Expired

verizon Basic **Advanced** Help

Network Device  
Verizon Router

**Firewall**

**Utilities**

**Network Settings**

- Network Objects
- Network Connections
- Universal Plug & Play
- Port Forwarding Rules
- IPv6
- Routing
- IPv4 Address Distribution
- IPv6 Address Distribution
- Port Configuration

**Date & Time**

**DNS Settings**

**Monitoring**

### Broadband Connection (Ethernet) Settings

Network Settings > Network Connections > Network Connection Broadband Settings

MTU: Automatic 1500

**WAN IP Address**

Internet Protocol: Obtain IPv4 Address Automatically

Override Subnet Mask: No IPv4 Address

DHCP Lease: Obtain IPv4 Address Automatically

Expires In: Use the following IPv4 Address

Expires In: Expired

IPv4 DNS: Obtain IPv4 DNS Address Automatically

Internet Connection Firewall:  Enable

This feature provides the ability to change the default firewall setting on this interface. We highly recommend that you do not change the default setting.

**Apply**

# NETWORK SETTINGS

---

2. Configure the following settings, as needed.

## General

Verify the following information:

- **Status** - displays the connection status of the network.
- **Network** – displays the type of network connection.
- **Connection Type** - displays the type of connection interface.
- **Physical Address** - displays the physical address of the network card used for the network.
- **MTU** - specifies the largest packet size permitted for internet transmissions:
  - **Automatic:** sets the MTU (Maximum Transmission Unit at 1500).
  - **Automatic by DHCP:** sets the MTU according to the DHCP connection.
  - **Manual:** allows you to manually set the MTU.

## 6.2c/ UNIVERSAL PLUG AND PLAY

You can use Universal Plug and Play (UPnP) to support new devices without configuring or rebooting your Verizon Router.

In addition, you can enable the automatic cleanup of invalid rules. When enabled, this functionality verifies the validity of all UPnP services and rules every five minutes. Old and unused UPnP defined services are removed, unless a user-defined rule depends on it.

UPnP services are not deleted when disconnecting a computer without proper shutdown of the UPnP applications, such as messenger. Services may often not be deleted and eventually this leads to the exhaustion of rules and services. No new services can be defined. The cleanup feature locates the invalid services and removes them, preventing services exhaustion.

*To access this setting:*

1. Select **Universal Plug & Play** in the **Network Settings** section.

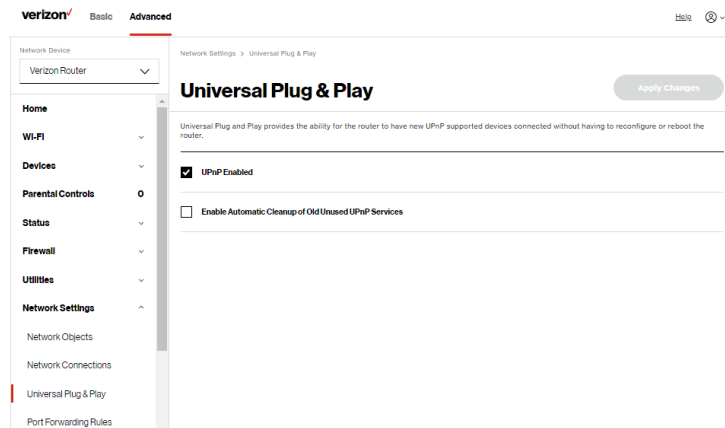

2. To enable UPnP and allow UPnP services to be defined on any network hosts, select the **UPnP Enabled** check box.
3. To enable automatic cleanup of invalid rules, select **Enable Automatic Cleanup of Old Unused UPnP Services** check box.
4. Click **Apply changes** to save changes.

# NETWORK SETTINGS

## 6.2d/ PORT FORWARDING RULES

You can view, modify, and delete port forwarding rules.

To access the rules:

1. Select **Port Forwarding Rules** in the **Network Settings** section.

The screenshot shows the Verizon Router's Network Settings interface. The 'Advanced' tab is selected. The left sidebar shows 'Network Settings' expanded, with 'Port Forwarding Rules' highlighted. The main content area is titled 'Port Forwarding Rules' and displays a table of currently configured protocols. Below the table is an 'Add new' button circled in red.

Protocols	Ports	
FTP	TCP Any → 21	<a href="#">Edit</a> <a href="#">Remove</a>
HTTP	TCP Any → 80	<a href="#">Edit</a> <a href="#">Remove</a>
HTTPS	TCP Any → 443	<a href="#">Edit</a> <a href="#">Remove</a>
IMAP	TCP Any → 143	<a href="#">Edit</a> <a href="#">Remove</a>
LDAP	UDP Any → 1701	<a href="#">Edit</a> <a href="#">Remove</a>
Dion	ICMP Echo Request	<a href="#">Edit</a> <a href="#">Remove</a>
POP3	TCP Any → 110	<a href="#">Edit</a> <a href="#">Remove</a>
SMTP	TCP Any → 25	<a href="#">Edit</a> <a href="#">Remove</a>
SNMP	UDP Any → 161	<a href="#">Edit</a> <a href="#">Remove</a>
Telnet	TCP Any → 23	<a href="#">Edit</a> <a href="#">Remove</a>
IEFP	UDP 1024 - 65535 → 69	<a href="#">Edit</a> <a href="#">Remove</a>
Tracert	UDP 32768 - 65535 → 33434 - 33523	<a href="#">Edit</a> <a href="#">Remove</a>

2. To create or edit a protocol rule, click the **Add new** or **Edit** icon in the Action column. The **Edit Service** page displays.

Network Device  
Verizon Router

Basic Advanced

Network Settings > Port Forwarding Rules > Edit Service

### Edit Service

**Edit Service**

Service Name

Service Description

**Service Ports**

Protocols	Ports
<input type="button" value="Add"/>	

3. Modify the **Service Name** and **Service Description**, as needed.
4. To add server ports, click **Add**.
5. To modify the current protocol, click the **Edit** icon in the Action column. The **Edit Service Server Ports** page displays.

# NETWORK SETTINGS

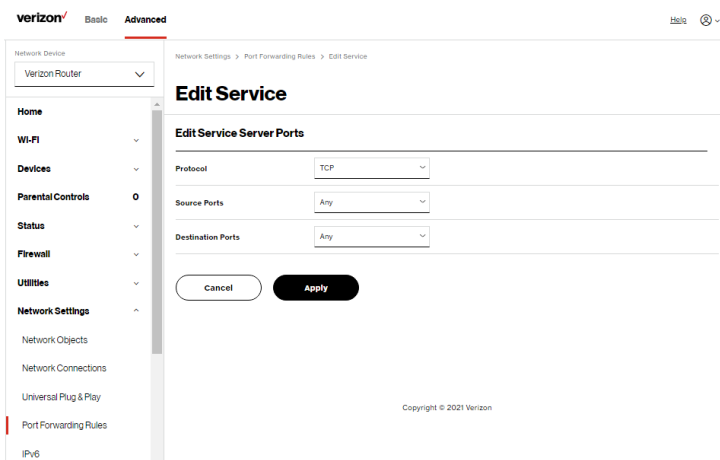

6. Enter the **Protocol**, **Source Ports** and **Destination Ports**, as needed.
7. Click **Apply** to save changes.

## 6.2e/ IPv6

Use the IPv6 feature settings to enable, disable, or configure an IPv6 Internet connection and IPv6 LAN settings.

1. To configure your network to use the IPv6 Internet connection type, select IPv6 from the Advanced page to display the IPv6 service options:

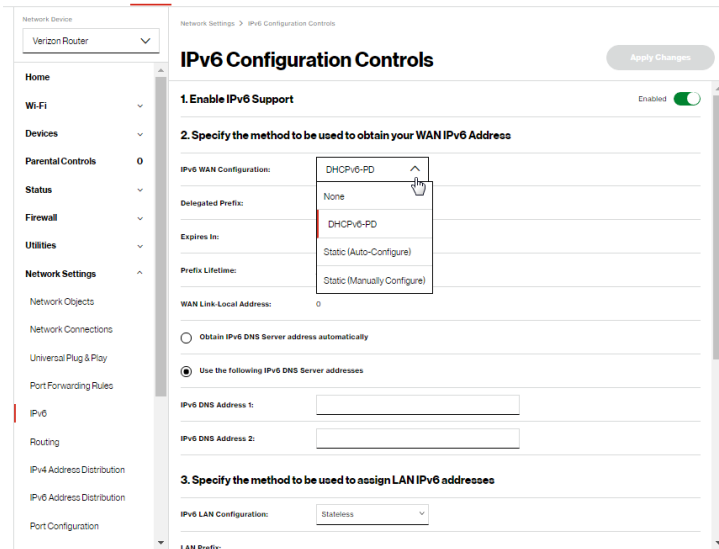

2. Select **Enable** in the **Enable IPv6 Support** field. (Once IPv6 is enabled the default setting will be IPv6 WAN as DHCPv6 and IPv6 LAN as Stateless).
  3. Select the appropriate IPv6 connection method from the dropdown list (DHCPv6 or Static) to specify the method to be used to obtain your WAN IPv6 Address.
  4. Click **Apply changes** to have changes take effect.
- Note: The Internet IPv6 service is required for this feature to work over the internet.*
5. To disable the IPv6 service, click on the **Disable** option in the **Enable IPv6 Support** field.
  6. Click **Apply changes** to have changes take effect.

# NETWORK SETTINGS

Once configured using valid IPv6 WAN and LAN configurations, you should not see any errors when you click on the **Apply changes** button and the **Status** page on the main menu will reflect the router's new IPv6 address.

You should also see the IPv6 address for all IPv6 supported devices on your local network displayed on the **Basic/Devices/Devices** page by selecting **Expanded List** from the dropdown list.

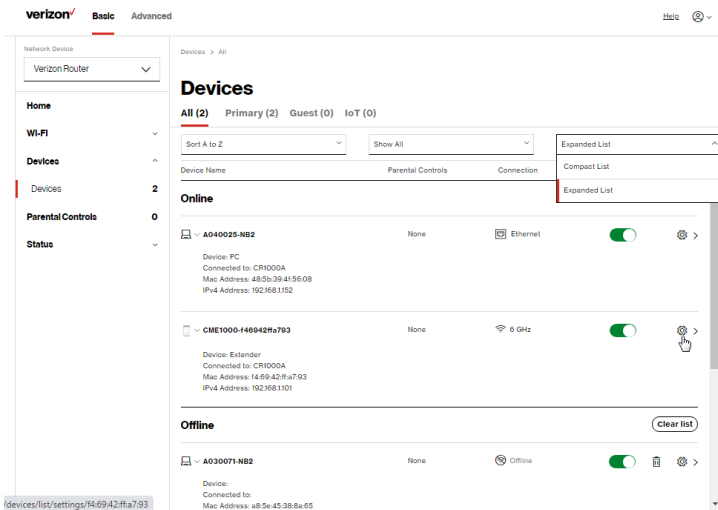

## Static - WAN IPv6 Address Connection

The IPv6 WAN Static configurations are IPv6 settings that you enter manually. These specific IPv6 addresses and settings are not expected to change frequently.

1. To configure IPv6 WAN Static mode, select the **Static** option on the **IPv6 Configuration Control** page as shown below:



Network Device  
Verizon Router

Home  
Wi-Fi  
Devices  
Parental Controls  
Status  
Firewall  
Utilities  
Network Settings  
Network Objects  
Network Connections  
Universal Plug & Play  
Port Forwarding Rules  
IPv6  
Routing  
IPv4 Address Distribution  
IPv6 Address Distribution  
Port Configuration

Network Settings > IPv6 Configuration Controls

## IPv6 Configuration Controls

Apply Changes

1. Enable IPv6 Support Enabled

2. Specify the method to be used to obtain your WAN IPv6 Address

IPv6 WAN Configuration:

Assigned Prefix:

IPv6 WAN Address:  /

Default Gateway:

IPv6 DNS Address 1:

IPv6 DNS Address 2:

3. Specify the method to be used to assign LAN IPv6 addresses

IPv6 LAN Configuration:

LAN Prefix:

IPv6 LAN Address:  /

LAN Link Local Address:

Router Advertisement Lifetime:  minutes (0-150)

2. Specify the **Static** method to be used to obtain your WAN IPv6 Address by entering:
  - **IPv6 WAN Configuration** (select Static)
  - **Assigned Prefix** (A numeric value between 16 and 128)
  - **IPv6 WAN Address**
  - **Default Gateway:** Verizon Router
  - **IPv6 (Primary) DNS Address 1**
  - **IPv6 (Secondary) DNS Address 2**
3. After entering all appropriate IPv6 settings, click **Apply changes** to have changes take effect.

# NETWORK SETTINGS

## Static WAN with LAN IPv6 Stateful Settings

1. To configure IPv6 LAN Stateful mode with **Static WAN**, select the **Stateful (DHCPv6)** option on the **IPv6 Configuration Control** page as shown below:

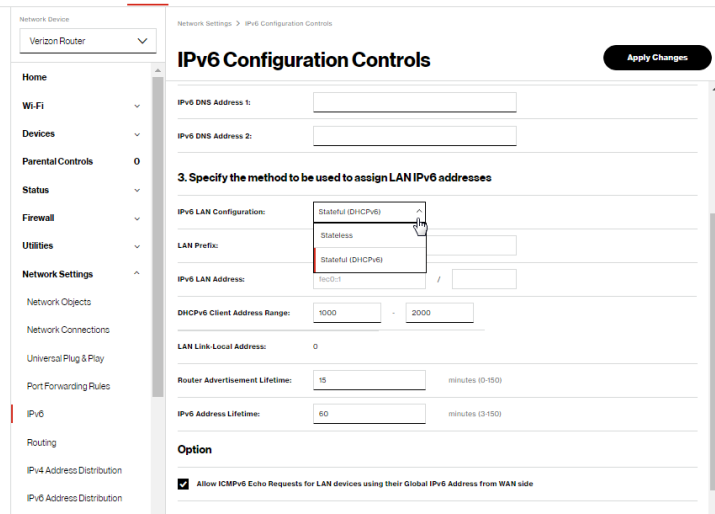

The screenshot displays the 'IPv6 Configuration Controls' page. On the left is a navigation menu with 'Network Settings' expanded to show 'IPv6'. The main content area is titled 'IPv6 Configuration Controls' and includes an 'Apply Changes' button. It features fields for 'IPv6 DNS Address 1' and 'IPv6 DNS Address 2'. A section titled '3. Specify the method to be used to assign LAN IPv6 addresses' contains a dropdown menu for 'IPv6 LAN Configuration' with 'Stateful (DHCPv6)' selected. Other fields include 'LAN Prefix', 'IPv6 LAN Address' (populated with 'fe80::1'), 'DHCPv6 Client Address Range' (1000 to 2000), 'LAN Link Local Address' (0), 'Router Advertisement Lifetime' (15 minutes), and 'IPv6 Address Lifetime' (60 minutes). An 'Option' section at the bottom has a checked checkbox for 'Allow ICMPv6 Echo Requests for LAN devices using their Global IPv6 Address from WAN side'.

2. Specify the **Stateful (DHCPv6)** settings to be used to assign LAN IPv6 addresses by entering the following details:
  - **IPv6 LAN Configuration** (select Stateful from the dropdown list)
  - **LAN Prefix** (automatically populated)
  - **IPv6 LAN Address** (automatically populated)
  - **DHCPv6 Client Address Range** (start and end)
  - **LAN Link Local Address** (automatically populated)

- **Subnet ID** - set the site topology for your internal site
  - **Router Advertisement Lifetime** (minutes between 0-150)
  - **IPv6 Address Lifetime** (minutes between 3-150)
  - **Option: Allow ICMPv6 Echo Request for LAN devices using their Global IPv6 Address from WAN side** - requesting an IPv6 address from any available DHCPv6 servers available on the ISP
3. After entering all appropriate IPv6 settings, click **Apply changes** to have changes take effect.

## Static WAN with LAN IPv6 Stateless Settings

1. To configure IPv6 LAN Stateless mode with **Static WAN**, select the **Stateless** option on the **IPv6 Configuration Control** page as shown below:

The screenshot displays the 'IPv6 Configuration Controls' page. On the left is a navigation sidebar with 'IPv6' selected. The main content area includes:

- Network Device:** Verizon Router
- IPv6 DNS Address 1:** [Empty field]
- IPv6 DNS Address 2:** [Empty field]
- 3. Specify the method to be used to assign LAN IPv6 addresses**
- IPv6 LAN Configuration:** A dropdown menu with 'Stateless' selected.
- LAN Prefix:** [Empty field]
- IPv6 LAN Address:** fe80::1 / [Empty field]
- LAN Link Local Address:** 0
- Router Advertisement Lifetime:** 15 minutes (0-150)
- Option:**  Allow ICMPv6 Echo Requests for LAN devices using their Global IPv6 Address from WAN side

# NETWORK SETTINGS

---

2. Specify the settings to be used to assign LAN IPv6 addresses by entering the following details:
  - **IPv6 LAN Configuration** (select Stateless from the dropdown list)
  - **LAN Prefix** (automatically populated)
  - **IPv6 LAN Address** (automatically populated)
  - **LAN Link Local Address** (automatically populated)
  - **Subnet ID** - set the site topology for your internal site
  - **Router Advertisement Lifetime** (minutes between 0-150)
  - **Option: Allow ICMPv6 Echo Request for LAN devices using their Global IPv6 Address from WAN side** - requesting an IPv6 address from any available DHCPv6 servers available on the ISP
3. After entering all appropriate IPv6 settings, click **Apply changes** to have changes take effect.

## **DHCPv6 PD - WAN IPv6 Address Connection**

The IPv6 WAN DHCPv6 configurations are IPv6 settings that you enter that will allow your IPv6 connection to be updated by the ISP as needed.

1. To configure IPv6 WAN Stateful (DHCPv6) mode, select the **DHCPv6-PD** option on the **IPv6 Configuration Control** page as shown below:

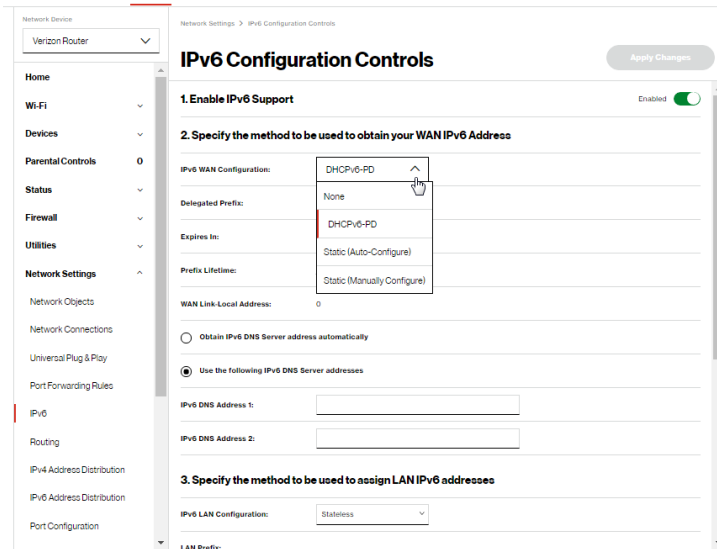

2. Check to either **Obtain IPv6 DNS Server address automatically**, or **Use the following IPv6 DNS Server addresses**
3. After entering all appropriate IPv6 settings, click **Apply changes** to have changes take effect.

## DHCPv6 WAN with LAN IPv6 Stateful (DHCPv6) Settings

1. To configure IPv6 WAN Stateful (DHCPv6) mode, select the **Stateful (DHCPv6)** option on the **IPv6 Configuration Control** page as shown below:

# NETWORK SETTINGS

Network Device: Verizon Router

## IPv6 Configuration Controls

Apply Changes

IPv6 DNS Address 1:

IPv6 DNS Address 2:

### 3. Specify the method to be used to assign LAN IPv6 addresses

IPv6 LAN Configuration:

LAN Prefix:

IPv6 LAN Address:

DHCPv6 Client Address Range:  -

LAN Link Local Address:

Router Advertisement Lifetime:  minutes (0-150)

IPv6 Address Lifetime:  minutes (0-150)

#### Option

Allow ICMPv6 Echo Requests for LAN devices using their Global IPv6 Address from WAN side

- Specify the **Stateful (DHCPv6)** settings to be used to assign LAN IPv6 addresses by entering the following details:
  - IPv6 LAN Configuration** (select Stateful from the dropdown list)
  - LAN Prefix** (automatically populated)
  - IPv6 LAN Address** (automatically populated)
  - DHCPv6 Client Address Range** (start and end)
  - LAN Link Local Address** (automatically populated)

- **Subnet ID** - set the site topology for your internal site
  - **Router Advertisement Lifetime** (minutes between 0-150)
  - **IPv6 Address Lifetime** (minutes between 3-150)
  - **Option: Allow ICMPv6 Echo Request for LAN devices using their Global IPv6 Address from WAN side** - requesting an IPv6 address from any available DHCPv6 servers available on the ISP
3. After entering all appropriate IPv6 settings, click **Apply changes** to have changes take effect.

## DHCPv6 WAN with LAN IPv6 Stateless Settings

1. To configure IPv6 LAN Stateless mode with DHCPv6 WAN, select the **Stateless** option on the **IPv6 Configuration Control** page as shown below:

The screenshot displays the 'IPv6 Configuration Controls' page in a web interface. On the left, a navigation menu includes 'Home', 'Wi-Fi', 'Devices', 'Parental Controls', 'Status', 'Firewall', 'Utilities', 'Network Settings', 'Network Objects', 'Network Connections', 'Universal Plug & Play', 'Port Forwarding Rules', 'IPv6', and 'Routing'. The 'Network Settings' section is expanded, and 'IPv6' is selected. The main content area shows the 'IPv6 Configuration Controls' page with a 'Verizon Router' selected in the 'Network Device' dropdown. The page includes an 'Apply Changes' button in the top right. The configuration fields are as follows: 'IPv6 DNS Address 1' and 'IPv6 DNS Address 2' are empty text boxes. A section titled '3. Specify the method to be used to assign LAN IPv6 addresses' contains: 'IPv6 LAN Configuration' set to 'Stateless' (with a dropdown menu open showing 'Stateless' selected); 'LAN Prefix' is an empty text box; 'IPv6 LAN Address' is 'fe80::1' followed by a slash and an empty box; 'LAN Link Local Address' is '0'; and 'Router Advertisement Lifetime' is '15' minutes (0-150). Under the 'Option' section, the checkbox 'Allow ICMPv6 Echo Requests for LAN devices using their Global IPv6 Address from WAN side' is checked.

# NETWORK SETTINGS

---

2. Specify the settings to be used to assign LAN IPv6 addresses by entering the following details:
  - **IPv6 LAN Configuration** (select Stateless from the dropdown list)
  - **LAN Prefix** (automatically populated)
  - **IPv6 LAN Address** (automatically populated)
  - **LAN Link Local Address** (automatically populated)
  - **Subnet ID** - set the site topology for your internal site
  - **Router Advertisement Lifetime** (minutes between 0-150)
  - **Option: Allow ICMPv6 Echo Request for LAN devices using their Global IPv6 Address from WAN side** - requesting an IPv6 address from any available DHCPv6 servers available on the ISP
3. After entering all appropriate IPv6 settings, click **Apply changes** to have changes take effect.

## **LAN IPv6 Configuration without An IPv6 WAN Connection**

1. To configure IPv6 to use either the IPv6 LAN Stateful or Stateless mode without using an IPv6 Internet WAN connection, select the **None** option on the **IPv6 Configuration Control** page.



Network Device  
Verizon Router

Home  
Wi-Fi  
Devices  
Parental Controls  
Status  
Firewall  
Utilities  
Network Settings  
Network Objects  
Network Connections  
Universal Plug & Play  
Port Forwarding Rules  
IPv6  
Routing  
IPv4 Address Distribution  
IPv6 Address Distribution  
Port Configuration

Network Settings > IPv6 Configuration Controls

### IPv6 Configuration Controls

Apply Changes

Enabled

**1. Enable IPv6 Support**

**2. Specify the method to be used to obtain your WAN IPv6 Address**

IPv6 WAN Configuration: DHCPv6-PD

Delegated Prefix: None

Expires In: DHCPv6-PD

Prefix Lifetime: Static (Auto-Configure)

Static (Manually Configure)

WAN Link-Local Address: 0

Obtain IPv6 DNS Server address automatically

Use the following IPv6 DNS Server addresses

IPv6 DNS Address 1:

IPv6 DNS Address 2:

**3. Specify the method to be used to assign LAN IPv6 addresses**

IPv6 LAN Configuration: Stateless

LAN Prefix:

2. After entering all appropriate IPv6 settings, click **Apply changes** to have changes take effect.

## LAN IPv6 Stateful (DHCPv6) with No WAN Settings

1. To configure IPv6 LAN Stateful mode with No WAN connection, select the Stateful option on the IPv6 Configuration Control page as shown below:

# NETWORK SETTINGS

The screenshot displays the 'IPv6 Configuration Controls' page. On the left is a navigation sidebar with categories like Home, Wi-Fi, Devices, Parental Controls, Status, Firewall, Utilities, and Network Settings. The main content area is titled 'IPv6 Configuration Controls' and includes an 'Apply Changes' button. The configuration fields are as follows:

- IPv6 DNS Address 1: [Empty text box]
- IPv6 DNS Address 2: [Empty text box]
- 3. Specify the method to be used to assign LAN IPv6 addresses**
- IPv6 LAN Configuration: [Dropdown menu showing 'Stateful (DHCPv6)' selected]
- LAN Prefix: [Empty text box]
- IPv6 LAN Address: [Empty text box]
- DHCPv6 Client Address Range: [1000] - [2000]
- LAN Link Local Address: [0]
- Router Advertisement Lifetime: [15] minutes (0-150)
- IPv6 Address Lifetime: [60] minutes (3-150)
- Option**
- Allow ICMPv6 Echo Requests for LAN devices using their Global IPv6 Address from WAN side

2. Specify the **Stateful (DHCPv6)** settings to be used to assign LAN IPv6 addresses by entering the following details:
  - **IPv6 LAN Configuration** (select Stateful from the dropdown list)
  - **LAN Prefix** (automatically populated)
  - **IPv6 LAN Address** (automatically populated)
  - **DHCPv6 Client Address Range** (start and end)
  - **LAN Link Local Address** (automatically populated)
  - **Subnet ID** - set the site topology for your internal site
  - **Router Advertisement Lifetime** (minutes between 0-150)
  - **IPv6 Address Lifetime** (minutes between 3-150)

- Option: Allow ICMPv6 Echo Request for LAN devices using their Global IPv6 Address from WAN side - requesting an IPv6 address from any available DHCPv6 servers available on the ISP
3. After entering all appropriate IPv6 settings, click **Apply changes** to have changes take effect.

## LAN IPv6 Stateless with No WAN Settings

1. To configure IPv6 LAN Stateless mode with No WAN connection, select the **Stateless** option on the **IPv6 Configuration Control** page as shown below:

The screenshot displays the 'IPv6 Configuration Controls' page. On the left is a navigation menu with 'IPv6' selected. The main content area includes:

- Fields for 'IPv6 DNS Address 1' and 'IPv6 DNS Address 2'.
- A section titled '3. Specify the method to be used to assign LAN IPv6 addresses' containing a dropdown menu for 'IPv6 LAN Configuration' (set to 'Stateless'), a 'LAN Prefix' field, and an 'IPv6 LAN Address' field (set to 'fe80::').
- A 'LAN Link Local Address' field set to '0'.
- A 'Router Advertisement Lifetime' field set to '15' minutes.
- An 'Option' section with a checked checkbox: 'Allow ICMPv6 Echo Requests for LAN devices using their Global IPv6 Address from WAN side'.
- An 'Apply Changes' button in the top right corner.

2. Specify the settings to be used to assign LAN IPv6 addresses by entering the following details:
  - **IPv6 LAN Configuration** (select Stateless from the dropdown list)

# NETWORK SETTINGS

---

- **LAN Prefix** (automatically populated)
  - **IPv6 LAN Address** (automatically populated)
  - **LAN Link Local Address** (automatically populated)
  - **Subnet ID** - set the site topology for your internal site
  - **Router Advertisement Lifetime** (minutes between 0-150)
  - **Option: Allow ICMPv6 Echo Request for LAN devices using their Global IPv6 Address from WAN side** - requesting an IPv6 address from any available DHCPv6 servers available on the ISP
3. After entering all appropriate IPv6 settings, click **Apply changes** to have changes take effect.

## **6.2f/ ROUTING SETTINGS**

You can view the routing and IP address distribution rules as well as add, edit, or delete the rules.

### **Routing Table**

*To view the rules:*

1. Select **Routing** in the **Network Settings** section.

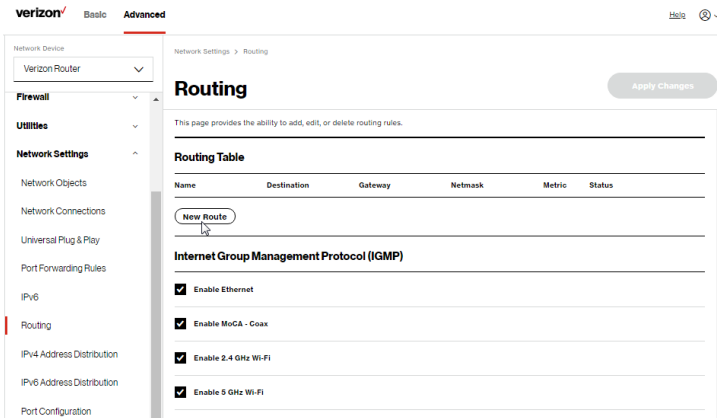

2. To add a new Route, click **New Route**.

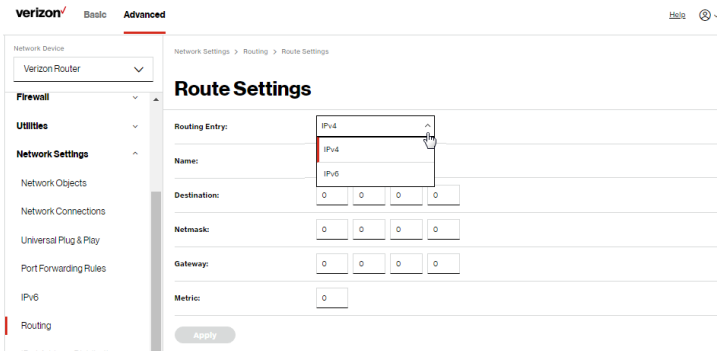

3. Specify the following parameters:
- **Routing Entry** - select the IP address type.
  - **Name** – the network connection type.

# NETWORK SETTINGS

---

- **Destination** - enter the destination IP of the destination host, subnet address, network address, or default route. The destination for a default route is 0.0.0.0.
  - **Netmask** – enter the network mask. This is used in conjunction with the destination to determine when a route is used.
  - **Gateway** – enter the IP address of your Verizon Router.
  - **Metric** – enter a measurement preference of the route. Typically, the lowest metric is the most preferred route. If multiple routes exist to a specific destination network, the route with the lowest metric is used.
4. Click **Apply changes** to save changes.

## Internet Group Management Protocol (IGMP)

IGMP allows for managing a single upstream interface and multiple downstream interfaces of the IGMP/MLD (Multicast Listener Discovery)-based forwarding. This function enables the system to send IGMP host messages on behalf of hosts that the system discovers through standard IGMP interfaces. Also, IGMP snooping allows an Ethernet switch to “listen in” on the IGMP conversation between hosts and routers, while IGMP querier will send out periodic IGMP queries.

*To enable this function:*

1. Choose the IGMP interfaces by clicking on the checkboxes on the screen.
2. Click **Apply changes** to save changes.

---

## 6.2g/ IPV4 ADDRESS DISTRIBUTION

You can easily add computers configured as DHCP clients to the network. The DHCP server provides a mechanism for allocating IP addresses to these hosts and for delivering network configuration parameters to the hosts.

For example, a client (host) sends a broadcast message on the network requesting an IP address for itself. The DHCP server then checks its list of available addresses and leases a local IP address to the host for a specific period of time and simultaneously designates this IP address as taken. At this point, the host is configured with an IP address for the duration of the lease.

The host can renew an expiring lease or let it expire. If it renews a lease, the host receives current information about network services, as it did during the original lease, allowing it to update its network configurations to reflect any changes that occurred since the first connection to the network.

If the host wishes to terminate a lease before its expiration, it sends a release message to the DHCP server. This makes the IP address available for use by other hosts.

*The DHCP server performs the following functions:*

- Displays a list of all DHCP host devices connected to your Verizon Router
- Defines the range of IP addresses that can be allocated in the network
- Defines the length of time the dynamic IP addresses are allocated

# NETWORK SETTINGS

- Provides the above configurations for each network device and can be configured and enabled or disabled separately for each network device
- Assigns a static lease to a network computer to receive the same IP address each time it connects to the network, even if this IP address is within the range of addresses that the DHCP server may assign to other computer
- Provides the DNS server with the host name and IP address of each computer connected to the network

To view a summary of the services provided by the DHCP server:

1. Select **IPv4 Address Distribution** in the **Network Settings** section.

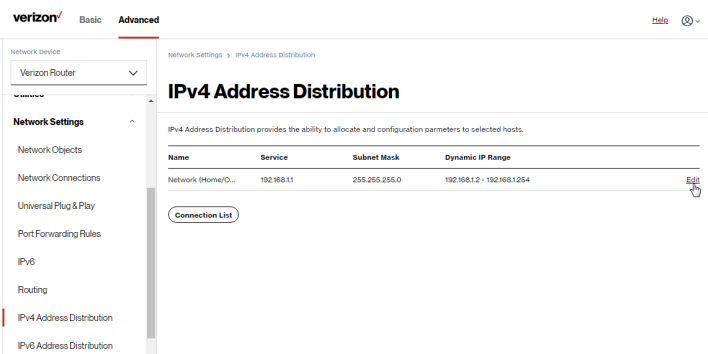

2. You can edit the DHCP server settings for a device. On the **IPv4 Address Distribution** page, click the **Edit** icon in the **Action** column. The DHCP Settings page opens with the device information displayed.
3. To enable the DHCP server, select **DHCP Server** in the **IPv4 Address Distribution** field.



- Once enabled, the DHCP server provides automatic IP assignments (IP leases) based on the preset IP range defined below.

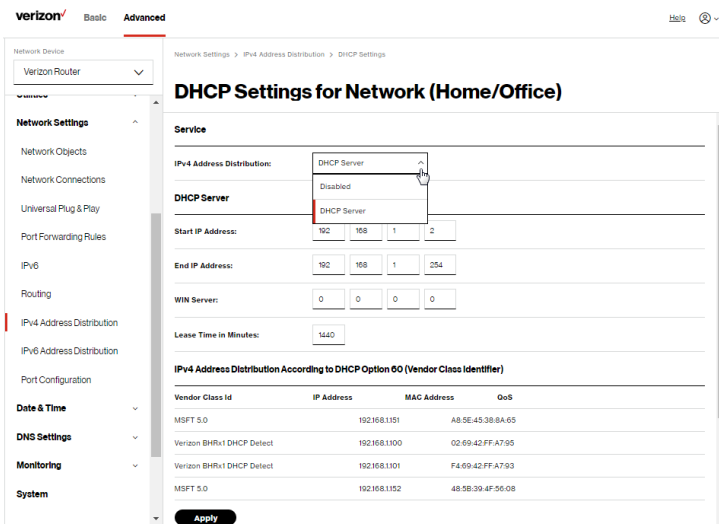

**DHCP Settings for Network (Home/Office)**

**Service**

IPv4 Address Distribution: DHCP Server

**DHCP Server**

Start IP Address: 192 168 1 2

End IP Address: 192 168 1 254

WIN Server: 0 0 0 0

Lease Time in Minutes: 1440

**IP4 Address Distribution According to DHCP Option 60 (Vendor Class Identifier)**

Vendor Class Id	IP Address	MAC Address	OvS
MSFT 5.0	192.168.1.151	A8-5E-45-38-8A-65	
Verizon BHRv1 DHCP Detect	192.168.1.100	02-69-42-FF-A7-95	
Verizon BHRv1 DHCP Detect	192.168.1.101	F4-69-42-FF-A7-93	
MSFT 5.0	192.168.1.152	48-5B-39-4F-56-08	

**Apply**

- To configure the DHCP server, complete the following fields:
  - Start IP Address** – enter the first IP address that your Verizon Router will automatically begin assigning IP addresses from. Since your Verizon Router’s default IP address is 192.168.1.1, the default start IP address should be 192.168.1.2.
  - End IP Address** – enter the last IP address that your Verizon Router will stop at for the IP address allocation. The maximum end IP address range that can be entered is 192.168.1.254.

# NETWORK SETTINGS

---

- **WINS Server** – determines the IP address associated with a network device.
- **Lease Time in Minutes** – assigns the amount of time in minutes that each device is assigned an IP address by the DHCP server when it connects to the network.

When the lease expires, the server determines if the computer has disconnected from the network. If it has, the server may reassign this IP address to a newly connected computer.

6. Click **Apply** to save changes.

## **IPv4 Address Distribution According to DHCP option 60 (Vendor Class Identifier)**

DHCP vendor class is related to DHCP option 60 configuration within the router. User can add option 60 configurations such that particular vendor can get lease from a specified pool of address. The existing vendor class ID, IP address, MAC address and QoS are shown on the screen above.

### **DHCP Connection List**

You can view a list of the connections currently assigned and recognized by the DHCP server.

*To view a list of computers:*

1. On the **IPv4 Address Distribution** page, click **Connection List**.

The screenshot shows the Verizon Network Settings interface. The left sidebar contains a navigation menu with options: Network Settings, Network Objects, Network Connections, Universal Plug & Play, Port Forwarding Rules, IPv6, Routing, IPv4 Address Distribution, and IPv6 Address Distribution. The main content area is titled "DHCP Connections" and includes a breadcrumb trail: Network Settings > IPv4 Address Distribution > DHCP Connections. Below the title, a note states: "IPv4 Address Distribution provides the ability to allocate and configuration parameters to selected hosts." A table lists four DHCP connections with columns for Host Name, IP Address, Physical Address, Lease Type, Connection Name, Status, and Expired in. Each row has a "Search" and "Edit" link. At the bottom of the table is an "Add static connection" button.

Host Name	IP Address	Physical Address	Lease Type	Connection Name	Status	Expired in
CME1000-446942...	192.168.1.100	02:69:42:FF:A7:95	Dynamic	Network (Home/O...	Active	1417 <a href="#">Search</a> <a href="#">Edit</a>
CME1000-446942...	192.168.1.101	F4:69:42:FF:A7:93	Dynamic	Network (Home/O...	Active	1417 <a href="#">Search</a> <a href="#">Edit</a>
A030071-18B2	192.168.1.151	A8:5E:45:38:8A:05	Dynamic	Network (Home/O...	Active	1401 <a href="#">Search</a> <a href="#">Edit</a>
NB1	192.168.1.152	48:5B:39:4F:56:08	Dynamic	Network (Home/O...	Active	1401 <a href="#">Search</a> <a href="#">Edit</a>

2. To define a new static connection with a fixed IP address, click **Add static connection**.

The screenshot shows the Verizon Network Settings interface for "DHCP Connection Settings". The left sidebar is the same as in the previous screenshot. The main content area is titled "DHCP Connection Settings" and includes a breadcrumb trail: Network Settings > IPv4 Address Distribution > DHCP Connection Settings. Below the title, there are input fields for "Host name:", "IP Address:" (with four individual digit boxes), and "MAC Address:" (with six individual digit boxes). An "Apply" button is located at the bottom of the form.

3. Enter the host name.
4. Enter the fixed IP address to be assigned.
5. Enter the MAC address of the network interface of the computer used with this DHCP static connection.
6. Click **Apply** to save changes.

# NETWORK SETTINGS

## 6.2h/ IPV6 ADDRESS DISTRIBUTION

To view a summary of the services provided by the DHCP server:

1. Select **IPv6 Address Distribution** in the **Network Settings** section.

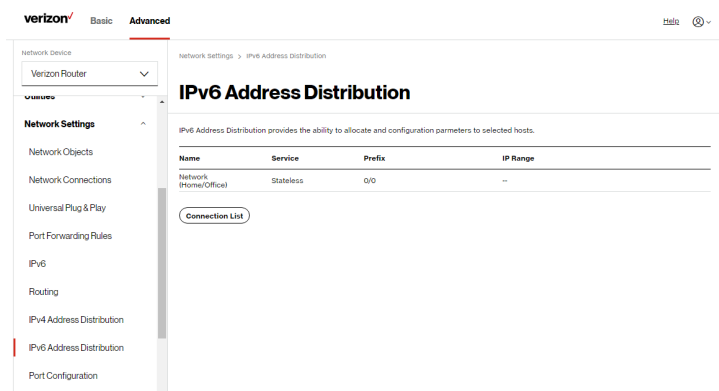

2. You can edit the DHCP server settings for a device. On the **IPv6 Address Distribution** page, click the **Edit** icon in the **Action** column. The DHCP Settings page opens with the device information displayed.
3. To configure the DHCP server complete the following fields:
  - **Start IPv6 Address** – the starting IPv6 address in the consecutive list of addresses that makes up this LAN pool for the DHCPv6 server.
  - **End IPv6 Address** – the ending IPv6 address in the consecutive list of addresses that makes up this LAN pool for the DHCPv6 server.

- **Lease Time in Minutes** – assigns the amount of time in minutes that each device is assigned an IP address by the DHCP server when it connects to the network.

When the lease expires, the server determines if the computer has disconnected from the network. If it has, the server may reassign this IP address to a newly connected computer.

4. Click **Apply** to save changes.

## DHCP Connection List

You can view a list of the connections currently assigned and recognized by the DHCP server.

*To view a list of computers:*

1. On the **IPv6 Address Distribution** page, click **Connection List**.
2. To define a new static connection with a fixed IP address, click **Add static connection**.
3. Enter the host name.
4. Enter the fixed IP address to be assigned.
5. Enter the MAC address of the network interface of the computer used with this DHCP static connection.
6. Click **Apply** to save changes.

# NETWORK SETTINGS

## 6.2i/ PORT CONFIGURATION

Ethernet port configuration allows you to set up the Ethernet ports as either full- or half-duplex ports, at either 10 Mbps, 100 Mbps, or 1000 Mbps.

*To configure the ports:*

1. Select **Port Configuration** in the **Network Settings** section.

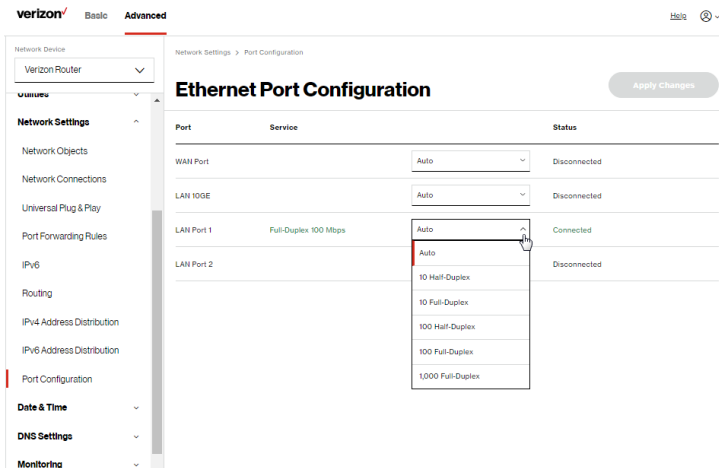

2. To emulate the speed and duplex configuration of the port with which it's communicating, select **Auto** or select the port speed and duplicity.
3. Click **Apply changes** to save changes.

## 6.3/ DATE & TIME

You can configure the following settings:

- Date & Time Settings – sets the time zone and enables automatic time updates.
- Scheduler Rules Settings – limits the activation of firewall rules to specific time periods.

### 6.3a/ DATE & TIME SETTINGS

You can set the time zone and enable automatic time updates.

*To configure the settings:*

1. From the **Advanced** menu, select **Date & Time**.
2. Select **Date & Time** in the **Date & Time** section.

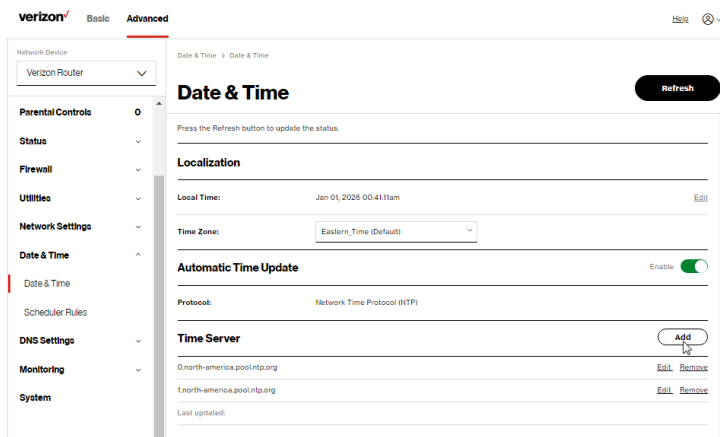

# DATE & TIME

3. Select the local time zone. Your Verizon Router automatically detects daylight saving times for selected time zone.
4. In the **Automatic Time Update** section, select the **Enabled** checkbox to perform an automatic time update.
5. Define the time server addresses by clicking **Add**. The **Time Server Settings** page displays.

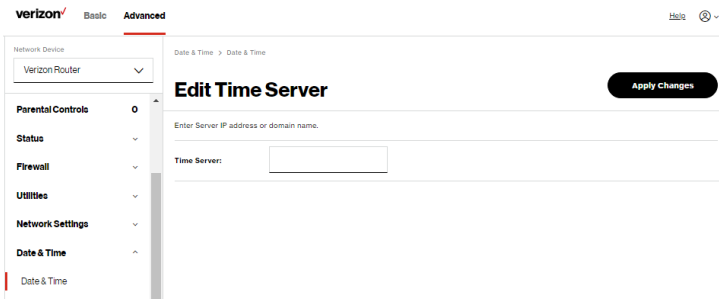

6. Enter the IP address or domain name of the time server, then click **Apply changes** to save changes.

## 6.3b/ SCHEDULER RULES

**Scheduler Rules** are used for limiting the activation of firewall rules to specific time periods. The time periods are either for days of the week or for hours of each day based on activity or inactivity.

*To define a rule:*

1. Verify that the date and time of your Verizon Router is correct.
2. Select **Scheduler Rules** in the **Date & Time** section.



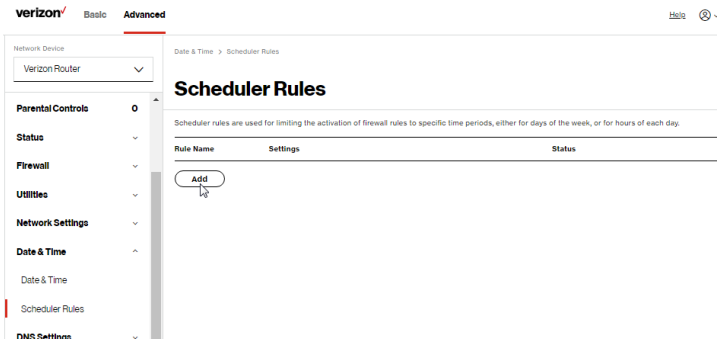

3. Click **Add**. The **Set Rule Schedule** page displays.

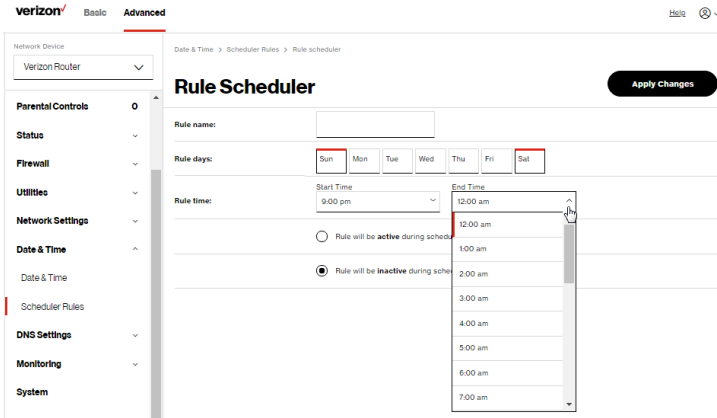

4. Enter the name of the rule, select the active or inactive days of the week and the start and end time range.
5. Specify if the rule is active at the scheduled time or inactive at the scheduled time.
6. Click **Apply changes** to save changes.

# DNS SETTINGS

---

## 6.4/ DNS SETTINGS

You can view and manage the DNS server host name and IP address as well as add a new computer. The DNS server does not require configuration.

### 6.4a/ DYNAMIC DNS

Typically, when connecting to the internet, your router is assigned an unused public IP address from a pool, and this address changes periodically.

Dynamic DNS allows a static domain name to be mapped to the dynamic IP address, allowing a computer within your network to be more easily accessible from the internet.

When using Dynamic DNS, each time the public IP address changes, the DNS database is automatically updated with the new IP address. In this way, even though the IP address changes often, the domain name remains constant and accessible.

*To set up dynamic DNS:*

1. From the **Advanced** menu, select **DNS Settings**.
2. Select **Dynamic DNS** in the **DNS Settings** section.

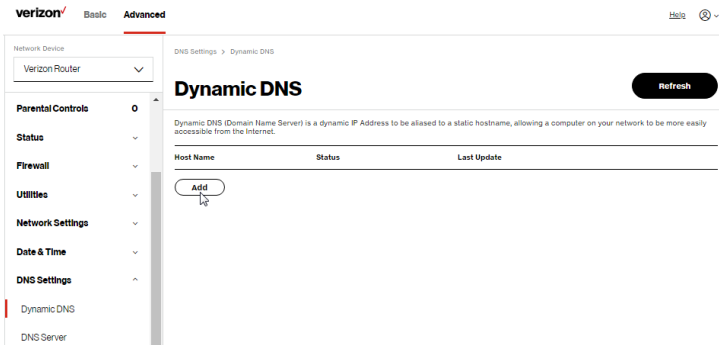

3. To set up a new entry, click the **Add** button.

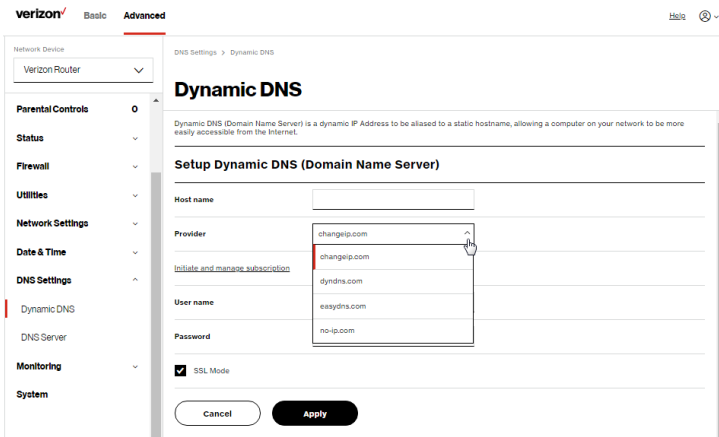

4. Configure the following parameters:

- **Host Name** – enter the full domain name for your Dynamic DNS domain.
- **Provider** – select the Dynamic DNS account provider from the menu.

# DNS SETTINGS

---

- **User Name** – enter your user name for your Dynamic DNS account.
  - **Password** – enter the password for your Dynamic DNS account.
  - **SSL Mode** – select if your Dynamic DNS service supports SSL.
5. Click **Apply** to save your changes.

*To edit the host name or IP address:*

1. In the **Action** column, click the **Edit** icon. The DNS Entry page displays.
2. Edit the settings.
3. Click **Apply** to save the changes.

## **6.4b/ DNS SERVER**

You can edit the host name and/or IP address, if the host was manually added to the DNS table. If not, you can only modify the host name.

*To access the DNS server:*

1. Select **DNS Server** in the **DNS** section.

Network Device: Verizon Router

Parental Controls: 0

Status: [v]

Firewall: [v]

Utilities: [v]

Network Settings: [v]

Date & Time: [v]

DNS Settings: [v]

Dynamic DNS

DNS Server

Monitoring: [v]

System

### DNS Server

Add, edit, or delete computers known by the router's DNS server

Host Name	IP Address	Source
AD40025-1B2	192.168.1.102	DHCP
CME1000-445942f7a793	192.168.1.101	DHCP

[Add DNS Entry](#)

Enable DNS Rebind Protection

To disable DNS Rebind Protection for all devices connected to this router, untick the checkbox above.  
To disable DNS Rebind Protection for specific IP addresses, create an exception with the dropdown below.

#### Exceptions to DNS Rebind Protection

IP/Netmask

[Add Exceptions Entry](#)

[Apply Changes](#)

2. To disable DNS rebind protection, untick the checkbox of **Enable DNS Rebind Protection**.

*Warning: Disabling this protection may create a risk of cybersecurity attack to devices connected to this router.*

3. To view and add computers stored in the **DNS** table, click **Add DNS Entry**. The **DNS Entry** page displays.

Network Device: Verizon Router

Parental Controls: 0

Status: [v]

Firewall: [v]

Utilities: [v]

Network Settings: [v]

Date & Time: [v]

DNS Settings: [v]

Dynamic DNS

### DNS Server

#### DNS Entry

Host Name: [text input]

IP Address: [0] [0] [0] [0]

[Apply](#)

# MONITORING

---

4. In the **Host Name** field, enter the name of the computer, then enter the **IP address** and click **Apply** to save changes.
5. Then the **DNS Server** page displays.
6. To edit the host name or IP address, click the **Edit** icon in the **Action** column. The **DNS Entry** page displays. Edit the host name and/or IP address.
7. To remove a host from the DNS table, click the **Delete** icon in the **Action** column.
8. Click **Apply changes** to save changes.

## 6.5/ MONITORING

You can view the details and status of:

- System Logging
- Full Status/System wide Monitoring of Connections/Traffic Monitoring
- Bandwidth Monitoring

### 6.5a/ SYSTEM LOGGING

System logging provides a view of the most recent activity of your Verizon Router. In addition, you can view additional logs, such as the security, advanced, firewall, WAN, DHCP, and LAN DHCP.

*To view the system log:*

1. From the **Advanced** menu, select **Monitoring**.
2. In the **Monitoring** section, click the **System Logging** link.

Verizon Basic Advanced

Network Device: Verizon Router

Monitoring > System Logging > System Log

### System Logging

Options Refresh Save

System Log Security Log Advanced Log Firewall Log WANDHCP Log LANDING Log

Time	Event type	Log Level	Details
2026 Jan 1 00:13:00	CR1000A	notice	[SYS] LED dim on/led pattern: )
2026 Jan 1 00:01:34	arc_wista_monitor	info	[WIFI.6][SYS] ACTION=assoc, WLAN=eth22, phy rate=4 Mbps, txop=99
2026 Jan 1 00:01:34	arc_wista_monitor	info	[WIFI.6][SYS] ACTION=assoc, WLAN=eth22, MAC=fc:69:42:ff:a7:93, RSSI=-30, RATE=2882 Mbps
2026 Jan 1 00:01:32	dnsmasq	info	[SYS.6][SYS] using local addresses only for domain myfiogateway.com
2026 Jan 1 00:01:32	dnsmasq	info	[SYS.6][SYS] using local addresses only for domain networksettings.com
2026 Jan 1 00:01:32	dnsmasq	info	[SYS.6][SYS] read /etc/ipv4_hosts - 4 addresses
2026 Jan 1 00:01:32	dnsmasq	info	[SYS.6][SYS] read /etc/ipv6_hosts - 0 addresses
2026 Jan 1 00:01:32	dnsmasq	info	[SYS.6][SYS] read /etc/hosts.dnsmasq-dns-ian0 - 7 addresses
2026 Jan 1 00:01:32	dnsmasq	info	[SYS.6][SYS] read /etc/hosts - 3 addresses
2026 Jan 1 00:01:32	dnsmasq	info	[SYS.6][SYS] using local addresses only for domain myfiogateway.com
2026 Jan 1 00:01:38	dnsmasq	info	[SYS.6][SYS] using local addresses only for domain

- To view a specific time of log event, click on the **options** button.

Verizon Basic Advanced

Network Device: Fios Router

Monitoring > System Logging > System Log

### System Logging

System Log Security Log Advanced Log Firewall Log WANDHCP Log LANDING Log

#### Log viewing options

Past day

Past week

Custom range

Start Date: 12/31/00 Start Time: 12:00 am

End Date: 12/31/00 End Time: 12:00 am

Cancel Save

- Click **Save** to save changes.

# MONITORING

5. To view a specific type of log event such as Security Log, WAN DHCP Log, etc., click the appropriate link in the menu on the top.
6. To update the data, click **Refresh**.

## 6.5b/ SYSTEM-WIDE CONNECTIONS

You can view a summary of the monitored data collected for your Verizon Router.

*To view your Verizon Router's full system status and traffic monitoring data:*

1. In the Monitoring section, click **System-wide Connections**.

The screenshot shows the Verizon Router's monitoring interface. The top navigation bar includes the Verizon logo, 'Basic', and 'Advanced' tabs. A left sidebar lists various settings categories, with 'Monitoring' expanded to show 'System-wide Connections'. The main content area is titled 'System-wide Connections' and features an 'Auto-refresh' button. Below the title is a table with columns for different connection types: Network (Home/Office), Broadband Connection (Ethernet/Coax), 5 GHz Wi-Fi Access Point 1, 6 GHz Wi-Fi Access Point 1, and 2.4 GHz Wi-Fi Access Point. The table displays connection status, underlying device, connection type, MAC address, IPv4 address, subnet mask, IPv4 default gateway, and IPv4 DNS address for each connection.

Name	Network (Home/Office)	Broadband Connection (Ethernet/Coax)	5 GHz Wi-Fi Access Point 1	6 GHz Wi-Fi Access Point 1	2.4 GHz Wi-Fi Access Point
Status	Connected	Connecting...	Disconnected	Connected	Disconnected
Underlying Device	Network (Home/Office)	Broadband Connection (Ethernet/Coax)	Network (Home/Office)	Network (Home/Office)	Network (Home/Office)
Connection Type	5 GHz Wi-Fi Access Point 6 GHz Wi-Fi Access Point 2.4 GHz Wi-Fi Access Point Ethernet Coax	Broadband Connection (Ethernet/Coax)	5 GHz Wi-Fi Access Point	6 GHz Wi-Fi Access Point	2.4 GHz Wi-Fi Access Point
MAC Address	88:5A:85:FE:C5:66	--	88:5A:85:FE:C5:68	88:5A:85:FE:C5:69	88:5A:85:FE:C5:67
IPv4 Address	192.168.1.1	--	--	--	--
Subnet Mask	255.255.255.0	--	--	--	--
IPv4 Default Gateway	192.168.1.1	--	--	--	--
IPv4 DNS Address	--	--	--	--	--



Network Device: Verizon Router

Monitoring > System-wide Traffic Connections

### System-wide Connections

Auto-refresh

IPv4 Default Gateway	192.168.1.1	--	--	--	--
IPv4 DNS Address	--	--	--	--	--
IPv4 Address Distrib.	DHCP Server	Disable	Disable	Disable	Disable
IPv6 Prefix	0/0	--	--	--	--
IPv6 Address	--	--	--	--	--
IPv6 Link-Local Address	--	--	--	--	--
IPv6 DNS Address	--	--	--	--	--
IPv6 Address Distrib.	Stateless	Disable	Disable	Disable	Disable
Rec'd Packets	11178	0	0	0	0
Sent Packets	8474	0	0	0	0
Rec'd Bytes	1189811	0	0	0	0

Network Device: Verizon Router

Monitoring > System-wide Traffic Connections

### System-wide Connections

Auto-refresh

Distrib.					
Rec'd Packets	11443	0	0	0	0
Sent Packets	8695	0	0	0	0
Rec'd Bytes	1225137	0	0	0	0
Sent Bytes	7416804	0	0	0	0
Rec'd Errors	0	0	0	0	0
Rec'd Drops	3	0	0	0	0
Time Span	0:50:26	0	0:50:26	0:50:26	0:50:26

2. To modify the connection properties, click the individual connection links.
3. To continuously refresh the page, click **Automatic refresh on**.

# SYSTEM SETTINGS

## 6.5c/ BANDWIDTH MONITORING

You can view and monitor the recorded bandwidth usage measured in Kbps.

*To view the bandwidth:*

1. In the **Monitoring** section, select **Bandwidth Monitoring**.

The screenshot shows the Verizon router's web interface. The top navigation bar includes the Verizon logo, 'Basic', and 'Advanced' tabs. The 'Advanced' tab is selected. On the right, there are links for 'Help' and a user profile icon. The main content area is titled 'Bandwidth Monitoring' and includes a table with columns for time intervals (Last min, 1min, 2min, 3min, 4min, 5min, 6min, 7min, 8min) and rows for Tx Rate, Rx Rate, and Last Hr. There are also buttons for 'Auto-refresh' and 'Refresh'.

Last min	1min	2min	3min	4min	5min	6min	7min	8min
Tx Rate	0 kb/s	0 kb/s	0 kb/s	0 kb/s	0 kb/s	0 kb/s	0 kb/s	0 kb/s
Rx Rate	0 kb/s	0 kb/s	0 kb/s	0 kb/s	0 kb/s	0 kb/s	0 kb/s	0 kb/s
Last Hr	1hr	2hr	3hr	4hr	5hr	6hr	7hr	8hr
Tx Rate	0 kb/s	0 kb/s	0 kb/s	0 kb/s	0 kb/s	0 kb/s	0 kb/s	0 kb/s
Rx Rate	0 kb/s	0 kb/s	0 kb/s	0 kb/s	0 kb/s	0 kb/s	0 kb/s	0 kb/s

2. To refresh the page, click **Refresh**.
3. To continuously refresh the page, click **Automatic refresh** on.

## 6.6/ SYSTEM SETTINGS

You can configure various system and management parameters.

*To configure system settings:*

1. From the **Advanced** menu, select **System**.

verizon Basic **Advanced** Help

Network Device  
Verizon Router

**System Settings** Apply Changes

**System**

**Router Status**

Router's Hostname: CR1000A

Local Domain: myfiosgateway.com

Location: Other

**Router**

Automatic Refresh of System Monitoring Web Pages

Prompt for Password When Accessing via LAN

Warn User Before Configuration Changes

Session lifetime: 600 seconds

Number of concurrent users that can be logged into the router: 5

**Remote Administration**

verizon Basic **Advanced** Help

Network Device  
Verizon Router

**System Settings** Apply Changes

**System**

Session lifetime: 600 seconds

Number of concurrent users that can be logged into the router: 5

**Remote Administration**

Primary HTTPS Management Port: 443

System Logging:  Disable

Remote System Notify Level: None

Remote Security Notify Level: None

DHCP Timeout: Warning seconds

# SYSTEM SETTINGS

---

2. In the **Router Status** section, configure the following:
  - **Verizon Router's Hostname** – enter the host name or URL address of your Verizon Router. Both names are the same.
  - **Local Domain** – view the local domain of the network.
3. In the **Router** section, configure the following by selecting the check box:
  - **Automatic Refresh of System Monitoring Web Pages** – activates the automatic refresh of system monitoring web pages.
  - **Prompt for Password when Accessing via LAN** – causes your Verizon Router to ask for a password when trying to connect to the network.
  - **Warn User Before Configuration Changes** – activates user warnings before network configuration changes take effect.
4. In the **Session Lifetime** field, specify the length of time required before re-entering a user name and password after your Verizon Router has been inactive.
5. In the **Number of concurrent users that can be logged into the router** field, select the number of users that can access your Verizon Router at the same time.
6. Select **Remote Administration** to configure the remote administration to your Verizon Router.

- 
7. Enter the **Primary HTTP Management Port**.  
Refer to 6.1h Remote Administration for using this feature.
  8. In the **System Logging** section, configure the following system log options:
    - **Enable Logging** – move the selector to **on** to activate system logging.
    - **Remote System Notify Level** – specify the type of information, such as none, error, warning, and information, received for remote system logging.
    - **Remote Security Notify Level** – specify the type of information, such as none, error, warning, and information, received for remote system logging.
    - **Remote System Host IP Address** – enter the IP address of system log server for Security Logging messages.
  9. In the **DHCP Timeout** section, specify the DHCP timeout.
  10. Click **Apply changes** to save changes.

---

07/

# TROUBLE SHOOTING

**7.0** Troubleshooting Tips

**7.1** Frequently Asked Questions

---

This chapter lists solutions for issues that may be encountered while using your Verizon Router as well as frequently asked questions.

Although the majority of the router's internet connectivity is automatic and transparent, if an issue does occur accessing the internet (e.g. complete loss of connectivity, inability to access services, etc.), you may need to take additional steps to resolve the problem.

# TROUBLESHOOTING TIPS

---

*Note: The advanced settings should only be configured by experienced network technicians to avoid adversely affecting the operation of your Verizon Router and your local network.*

## **7.0/ TROUBLESHOOTING TIPS**

### **7.0a/ IF YOU ARE UNABLE TO CONNECT TO THE INTERNET:**

- The first thing to check is whether your Verizon Router is powered on and is connected to the internet. Check the Router Status LED on the front of the Verizon Router. Be sure to refer to the “1.3a/ FRONT PANEL” on page 9 to determine status of the Verizon Router. Check the WAN cable connecting your Verizon Router to the internet to make sure it is properly connected on both ends.
- If the prior tips do not resolve your connection issue, try restarting (rebooting) the router portion of the Verizon Router by manually pressing the ‘red’ reset power button on the rear panel of the Verizon Router for 2-4 seconds (the Router Status LED should go off) to begin rebooting your Verizon Router. Your Verizon Router will begin rebooting and will return to service in 3 - 5 minutes depending on your network connection. Check Router Status LED and if it is solid white, try again to access the internet.
- If rebooting your router does not resolve your connection issue, try power cycling the Verizon Router by unplugging the power cable from the adapter or the wall and wait 2 minutes. During the 2 min. wait period, also power cycle the network device (e.g.



the computer, tablet, etc.) and then plug the power cable back into the Verizon Router. After 3-5 minutes, recheck the Router Status LED and try again to access the internet.

### **7.0b/ IF YOU ARE UNABLE TO CONNECT TO YOUR VERIZON ROUTER USING WI-FI:**

- Be sure your Wi-Fi device is within range of your Verizon Router; move it closer to see if your connection improves.
- Check your network device's Wi-Fi settings to be sure your device's Wi-Fi is on (enabled) and that you have the correct Wi-Fi network and password (if using a Wi-Fi password) as configured on your Verizon Router.
- Be sure you are connecting to the correct Wi-Fi network; check to be sure you are using your Verizon Router's SSID. In some cases, if using a Wi-Fi password, you may need to enter the Wi-Fi password into your network device again to be sure your device accepts the password.
- Check to be sure you are running the latest software for your network device.
- Try turning your network device's Wi-Fi off and on, and try to connect.
- If you have made any changes in your network settings and turning your network device's Wi-Fi off and on does not help, try to restart your network device.
- You may need to turn the Wi-Fi settings from on to off, and back to on again and apply the changes.

# TROUBLESHOOTING TIPS

---

- If you are still unable to access your Verizon Router, you may need to try connecting to the Verizon Router using another network device. If the issue goes away with another network device, the issue is likely with that individual network device's configuration.

## **7.0c/ ACCESSING YOUR VERIZON ROUTER IF YOU ARE LOCKED OUT**

- If your Verizon Router connection is lost while making configuration changes, a setting that locks access to your Verizon Router's UI may have inadvertently been activated.

*The common ways to lock access to your Verizon Router are:*

- Scheduler - If a schedule has been created that applies to the computer over the connection being used, your Verizon Router will not be accessible during the times set in the schedule.
- Access Control - If the access control setting for the computer is set to block the computer, access to your Verizon Router is denied.

To gain access, restore the default settings to your Verizon Router.

## **7.0d/ RESTORING YOUR VERIZON ROUTER'S DEFAULT SETTINGS**

There are two ways to restore your Verizon Router's default settings. It is important to note that after performing either procedure, all previously save settings on your Verizon Router will be lost.

For additional information regarding the Restore Defaults feature, refer to section 6.1/ Utilities/Save And Restore.

- Using the tip of a ballpoint pen or pencil, press and hold the Reset button on the back of your Verizon Router for three seconds.
- Access the UI and navigate to the Advanced Settings page. Select the 6.1b Save and Restore option. After saving your configuration, if desired, click the Restore Factory Defaults radio button. For additional details, refer to the 6.1/ Utilities/Save And Restore section of this guide.

***Note:** If you reset or reboot your Verizon Router, you may also need to disconnect your Verizon Router's power supply for a few minutes (3 or more) and then reconnect the power cable. However, in order to provide full synchronization to the coaxial network, disconnecting and reconnecting the power may be required.*

## **7.0e/ LAN CONNECTION FAILURE**

*To troubleshoot a LAN connection failure:*

- Verify your Verizon Router is properly installed, LAN connections are correct, and that the Verizon Router and communicating network devices are all powered on.
- Confirm that the computer and Verizon Router are both on the same network segment.

If unsure, let the computer get the IP address automatically by initiating the DHCP function, then verify the computer is using

# TROUBLESHOOTING TIPS

---

an IP address within the default range of 192.168.1.2 through 192.168.1.254. If the computer is not using an IP address within the correct IP range, it will not connect to your Verizon Router.

- Verify the subnet mask address is set to 255.255.255.0.

## **7.0f/ TIMEOUT ERROR OCCURS WHEN ENTERING THE URL OR IP ADDRESS**

*Verify the following:*

- All computers are working properly.
- IP settings are correct.
- Verizon Router is on and connected properly.
- Verizon Router settings are the same as the computer.

*For connections experiencing lag or a slow response:*

- Check for other devices on the network utilizing large portions of the bandwidth and if possible temporarily stop their current utilization and recheck the connection.
- If lag still exists, clear the cache on the computer and if still needed, unplug the Ethernet cable or disable the Wi-Fi connection to the computer experiencing the slow connection and then reconnect or enable the Wi-Fi connection and try the connection again.

*In rare cases you may also need to:*

- Unplug the Ethernet cable to Verizon Router and restart the Verizon Router, wait 1-2 mins. and insert the Ethernet cable again.

- Under limited circumstances you may use a port forwarding configuration on the router, based on the application you are using (refer to the 6.0d/ Port Forwarding section or Verizon's support online help for more details).

## 7.0g/ ROUTER STATUS LED

The Router Status LED provides a visual display of the Verizon Router's current condition. Refer to the chart below for details.

Condition Status	LED Color	Verizon Router
Normal	WHITE	Normal operation (solid) Router is booting (fast blink) System restart (fast blink)
	BLUE	Pairing mode (slow blink) WPS pairing successful (fast blink)
	GREEN	Wi-Fi has been turned off (solid)
Issue(s)	YELLOW	No internet connection (solid)
	RED	Hardware/System failure detected (slow blink) Overheating (fast blink) System update error (fast blink) WPS pairing failure (fast blink)
Power	OFF	Power off

# FREQUENTLY ASKED QUESTIONS

---

## **7.1/ FREQUENTLY ASKED QUESTIONS**

### **7.1a/ I'VE RUN OUT OF ETHERNET PORTS ON MY VERIZON ROUTER. HOW DO I ADD MORE COMPUTERS OR DEVICES?**

Plugging in an Ethernet hub or switch expands the number of ports on your Verizon Router.

- Run a straight-through Ethernet cable from the Uplink port of the new hub to the Verizon Router.

Use a crossover cable if there is no Uplink port/switch on your hub, to connect to the Verizon Router.

- Remove an existing device from the Ethernet port on your Verizon Router and use that port.

### **7.1b/ HOW DO I CHANGE THE PASSWORD ON MY VERIZON ROUTER UI?**

*To change the password:*

1. On the main screen, select **Advanced**, then select **Users** in the **Utilities** section.
2. Click the **Edit** in the **Action** column. The **User Settings** page displays.
3. Edit the user name and set a new password.

---

**7.1c/ IS THE WI-FI OPTION ON BY DEFAULT ON MY VERIZON ROUTER?**

Yes, your Verizon Router's Wi-Fi option is activated out of the box.

**7.1d/ IS THE WI-FI SECURITY ON BY DEFAULT WHEN THE WI-FI OPTION IS ACTIVATED?**

Yes, with the unique WPA2 (Wi-Fi Protected Access II) key that is printed on the sticker on the rear panel of your Verizon Router.

**7.1e/ ARE MY VERIZON ROUTER'S ETHERNET PORTS AUTO-SENSING?**

Yes. Either a straight-through or crossover Ethernet cable can be used.

**7.1f/ CAN I USE AN OLDER WI-FI DEVICE TO CONNECT TO MY VERIZON ROUTER?**

Yes, your Verizon Router can interface with 802.11b, g, n, ac or ax devices. Your Verizon Router also can be setup to handle only n Wi-Fi cards, g Wi-Fi cards, b Wi-Fi cards, or any combination of the three.

# FREQUENTLY ASKED QUESTIONS

---

## **7.1g/ CAN MY WI-FI SIGNAL PASS THROUGH FLOORS, WALLS, AND GLASS?**

The physical environment surrounding your Verizon Router can have a varying effect on signal strength and quality. The denser the object, such as a concrete wall compared to a plaster wall, the greater the interference. Concrete or metal reinforced structures experience a higher degree of signal loss than those made of wood, plaster, or glass.

## **7.1h/ HOW DO I LOCATE THE IP ADDRESS THAT MY COMPUTER IS USING?**

In Windows 7 or Windows 10, click the Windows button and select Control Panel, then click View Network Status and Tasks. In the next window, click Local Area Connection. In the Local Area Network Connection Status window, click Details.

On Mac OS X, open System Preferences and click the Network icon. The IP address displays near the top of the screen.

To find the IP address from the router GUI:

1. From the **Basic** menu, select **Devices** from the left pane.
2. Select **Expanded List** from the dropdown list to view detailed IP address information for all connected devices.



---

**7.1i/ I USED DHCP TO CONFIGURE MY NETWORK. DO I NEED TO RESTART MY COMPUTER TO REFRESH MY IP ADDRESS?**

No. In Windows 7, Windows 10 and OSX, unplug the Ethernet cable or Wi-Fi card, then plug it back in.

**7.1j/ I CANNOT ACCESS MY VERIZON ROUTER UI. WHAT SHOULD I DO?**

If you cannot access the UI, verify the computer connected to your Verizon Router is set up to dynamically receive an IP address.

**7.1k/ I HAVE A FTP OR WEB SERVER ON MY NETWORK. HOW CAN I MAKE IT AVAILABLE TO USERS ON THE INTERNET?**

For a web server, enable port forwarding for port 80 to the IP address of the server. Also, set up the web server to receive that port. Configuring the server to use a static IP address is recommended.

For a FTP server, enable port forwarding for port 21 to the IP address of the server. Also, set up the web server to receive that port. Configuring the server to use a static IP address is recommended.

# FREQUENTLY ASKED QUESTIONS

---

## **7.11/ HOW MANY COMPUTERS CAN BE CONNECTED THROUGH MY VERIZON ROUTER?**

Your Verizon Router is capable of 254 connections, but we recommend having no more than 132 connections. As the number of connections increases, the available speed for each computer decreases.

---

08 /

# SPECIFICATIONS

- 8.0** General Specifications
- 8.1** LED Indicators
- 8.2** Environmental Parameters

The specifications for your Verizon Router are as follows.

This includes standards, cabling types and environmental parameters.

# GENERAL SPECIFICATIONS

---

*Note: The specifications listed in this chapter are subject to change without notice.*

## **8.0/** GENERAL SPECIFICATIONS

Model Number:	CR1000A
Standards:	IEEE 802.3x, 802.3u, 802.3ab, 802.3bz, 802.3 an  IEEE 802.11a/b/g/n/ac/ax
IP:	IP versions 4 and 6
MoCA LAN:	1125 – 1675 MHz 2500 Mbps
Speed:	Wired:  10GE WAN Ethernet: 100 Mbps, 1/2.5/5/10 Gbps auto-sensing  10GE LAN Ethernet: 100 Mbps, 1/2.5/5/10 Gbps auto-sensing  2.5GE LAN Ethernet: 10/100 Mbps, 1/2.5 Gbps auto-sensing  Wireless:  2.4 GHz - IEEE 802.11b/g/n: maximum up to 600 Mbps IEEE 802.11ax: maximum up to 1.1 Gbps

---

	5 GHz - IEEE 802.11a/n/ac: maximum up to 2.2 Gbps IEEE 802.11ax: maximum up to 2.4 Gbps
	6 GHz - IEEE 802.11ax: maximum up to 4.8 Gbps
Cabling Type:	Ethernet 100BaseT: UTP/STP Category 5  Ethernet 1000BaseT: UTP/STP Category 5e  Ethernet 2.5/5/10GBaseT: UTP/STP Category 6a
Firewall:	ICSA certified

## 8.1/ LED INDICATORS

Front Panel:	Router Status LED
Rear Panel:	WAN Ethernet and LAN Ethernet [3]

# ENVIRONMENTAL PARAMETERS

---

## **8.2/ ENVIRONMENTAL PARAMETERS**

### **DIMENSIONS AND WEIGHT**

Verizon Router (unit only):

Size: 4.72" wide x 9.85" high x 4.72" deep

Weight: 2.96 lbs / 1.344 kg

Complete System (inc. packaging):

Size: 10.71" wide x 7" high x 8.66" deep

Weight: 5.51 lbs / 2.5 kg

Power:

External, 12V, 5A

Mounting Bracket (optional):

Size: 3.97" wide x 6.86" high x 6.6" deep

Weight: 0.39 lbs / 175 g

Screws (optional):

PH TP+N: 0.157" x 0.984"

PE Anchor: 0.236" x 0.984"

---

Certifications:	FCC, UL 62368, WFA
Operating Temperature:	5° C to 40° C (41° F to 104° F)
Storage Temperature:	-5° C to 50° C (23° F to 122° F)
Operating Humidity:	5% to 85%
Storage Humidity:	5% to 93% (non-condensing)



---

*09 /*

# **NOTICES**

**9.0** Regulatory Compliance Notices

---

This chapter lists various compliance and modification notices, as well as the NEBS requirements and GPL.

# REGULATORY COMPLIANCE NOTICES

---

## **9.0/ REGULATORY COMPLIANCE NOTICES**

### **9.0a/ Class B Equipment**

#### **Federal Communication Commission Interference Statement:**

This equipment has been tested and found to comply with the limits for a Class B digital device, pursuant to part 15 of the FCC Rules. These limits are designed to provide reasonable protection against harmful interference in a residential installation. This equipment generates, uses and can radiate radio frequency energy and, if not installed and used in accordance with the instructions, may cause harmful interference to radio communications. However, there is no guarantee that interference will not occur in a particular installation. If this equipment does cause harmful interference to radio or television reception, which can be determined by turning the equipment off and on, the user is encouraged to try to correct the interference by one or more of the following measures:

- Reorient or relocate the receiving antenna.
- Increase the separation between the equipment and receiver.
- Connect the equipment into an outlet on a circuit different from that to which the receiver is connected.
- Consult the dealer or an experienced radio/ TV technician for help.

FCC Caution: Any changes or modifications not expressly approved by the grantee of this device could void the user's authority to operate the equipment.

FCC regulations restrict the operation of this device to indoor use only.

The operation of this device is prohibited on oil platforms, cars, trains, boats, and aircraft, except that operation of this device is permitted in large aircraft while flying above 10,000 feet.

Operation of transmitters in the 5.925-7.125 GHz band is prohibited for control of or communications with unmanned aircraft systems.

### **RF Exposure:**

To comply with FCC RF exposure compliance requirements, the antenna used for this transmitter must be installed to provide a separation distance of at least 31cm from all persons (indoor), and must not be co-located or operating in conjunction with any other antenna or transmitter.

This device complies with Part 15 of the FCC Rules. Operation is subject to the following two conditions: (1) this device may not cause harmful interference, and (2) this device must accept any interference received, including interference that may cause undesired operation.

# REGULATORY COMPLIANCE NOTICES

---

## **9.0b/ Safety Warning:**

1. The circuit of cable distribution system under consideration is TNV-1 circuit.
2. The common sides or earthed side of the circuit are connected to the screen of the coaxial cable through an antenna connector of tuner and to all accessible parts and circuits (SELV, LCC and accessible metal parts).
3. The screen of the coaxial cable is intended to be connected to earth in the building installation.

## **9.0c/ Alerte de sécurité:**

1. Le circuit de distribution par câble considéré est le circuit TNV-1.
2. Les côtés communs ou côté terre du circuit sont connectés à l'écran du câble coaxial via un connecteur d'antenne du syntoniseur et à toutes les parties et circuits accessibles (SELV, LCC et parties métalliques accessibles).
3. L'écran du câble coaxial est destiné à être mis à la terre dans l'installation du bâtiment.

The cable distribution system should be grounded (earthed) in accordance with ANSI/NFPA 70, the National Electrical Code (NEC), in particular Section 820.93, Grounding of Outer Conductive Shield of a Coaxial Cable.

Le système de distribution par câble doit être mis à la terre conformément à ANSI / NFPA 70, Code national de l'électricité (NEC), en particulier à la section 820.93, Mise à la terre du blindage conducteur extérieur d'un câble coaxial.

### **9.0d/ NEBS (Network Equipment Building System) Statement**

An external SPD is intended to be used with CR1000A/CME1000.

**WARNING:** The intra-building ports of the equipment or subassembly is suitable for connection to intra-building or unexposed wiring or cabling only. The intra-building port(s) of the equipment or subassembly **MUST NOT** be metalically connected to interfaces that connect to the OSP or its wiring. These interfaces are designed for use as intra-building interfaces only (Type 4 ports as described in GR-1089) and require isolation from the exposed OSP cabling. The addition of Primary Protectors is not sufficient protection in order to connect these interfaces metalically to OSP wiring.

# REGULATORY COMPLIANCE NOTICES

---

*Caution: The Verizon Router must be installed inside the home. The Router is not designed for exterior installation.*

## **9.0e/ GENERAL PUBLIC LICENSE**

This product includes software made available under open source licenses. Additional information about that software, applicable licenses, and downloadable copies of source code, is available at:

<https://verizon.com/opensource/>

All open source software contained in this product is distributed **WITHOUT ANY WARRANTY**. All such software is subject to the copyrights of the authors and to the terms of the applicable licenses included in the download.

This information is provided for those who wish to edit or otherwise change such programs. You do not need a copy of any of such open source software source code to install or operate the device.