



Installation and Operation Manual

VMS1100

Hybrid QAM/IP Video Media Server

© 2014 ARRIS Enterprises, Inc. All rights reserved.

ARRIS and the ARRIS logo are all trademarks of ARRIS Enterprises, Inc. HDMI, the HDMI Logo and High-Definition Multimedia Interface are trademarks or registered trademarks of HDMI Licensing LLC. Manufactured under license from Dolby Laboratories. "Dolby", "Pro Logic", and the double-D symbol are trademarks of Dolby Laboratories. Rovi and Macrovision are trademarks owned by Rovi Corp. formerly known as Macrovision Corp. CableCARD™ and MCARDTM are trademarks or registered trademarks of Cable Television Laboratories, Inc. MoCA and the MoCA logo are trademarks of Multimedia over Coax Alliance. All other product or service names are the property of their respective owners.

No part of this publication may be reproduced in any form or by any means or used to make any derivative work (such as translation, transformation, or adaptation) without written permission from ARRIS Enterprises, Inc. ("ARRIS"). ARRIS reserves the right to revise this publication and to make changes in content from time to time without obligation on the part of ARRIS to provide notification of such revision or change.



Safety and Compliance

IMPORTANT SAFETY INSTRUCTIONS

- Read these instructions.
- Keep these instructions.
- Heed all warnings.
- Follow all instructions.
- Do not use this apparatus near water. The apparatus shall not be exposed to dripping or splashing and no objects filled with liquids, such as vases, shall be placed on the apparatus.
- Clean only with dry cloth.
- Do not block any ventilation openings. Install in accordance with the manufacturer's instructions.
- Do not install near any heat sources such as radiators, heat registers, stoves, or other apparatus (including amplifiers) that produce heat.
- Do not defeat the safety purpose of the polarized or grounding-type plug. A polarized plug has two blades with one wider than the other. A grounding type plug has two blades and a third grounding prong. The wide blade or the third prong is provided for your safety. If the provided plug does not fit into your outlet, consult an electrician for replacement of the obsolete outlet.
- Protect the power cord from being walked on or pinched particularly at plugs, convenience receptacles, and the point where they exit from the apparatus.
- Only use attachments/accessories specified by the manufacturer.
- Unplug this apparatus during lightning storms or when unused for long periods of time.
- Refer all servicing to qualified service personnel. Servicing is required when the apparatus has been damaged in any way, such as the power supply cord or plug is damaged, liquid has been spilled or objects have fallen into the apparatus, the apparatus has been exposed to rain or moisture, does not operate normally, or has been dropped.

IMPORTANT SAFETY CONSIDERATIONS

WARNING - To reduce the risk of fire or electric shock, do not expose this apparatus to rain or moisture.

The VMS requires careful handling to avoid potential damage to its internal components such as the hard disk drive which can lead to the loss of recorded data. Be sure to follow these requirements during transportation and installation.

During Transportation to the Subscriber Home

- Transport the VMS in its shipping box or an equally padded container.
- Do not expose the terminal to rain or moisture.

During Installation



- Do not place the VMS in an enclosed area where the cooling vents are blocked or impede the flow of air through the ventilation openings.
- Install the VMS so that its position does not interfere with its proper ventilation. For example, do not place the VMS on a bed, sofa, rug, or similar surface that could block the ventilation openings.
- Install the VMS away from heat sources such as radiators, heat registers and stoves. Installation of the VMS near consumer electronics devices, such as stereo receiver/amplifiers and televisions, is permitted as long as the air surrounding the VMS does not exceed 40° C (104° F).
- Place the VMS on a flat surface not prone to vibration or impact.
- Do not install the VMS in an area where condensation occurs.
- To prevent the temporary loss of guide data and cause a temporarily non-responding VMS, do not plug the AC power cord into a switched power outlet.
- To avoid shock and vibration damage to the internal hard drive, do not move the VMS while it is plugged in.
- To allow the hard drive to spin down and park its heads, wait at least 10 seconds after disconnecting power before moving the VMS.

FCC COMPLIANCE

This equipment has been tested and found to comply with the limits for a Class B digital device, pursuant to part 15 of the FCC Rules. These limits are designed to provide reasonable protection against harmful interference in a residential installation. This equipment generates uses and can radiate radio frequency energy and, if not installed and used in accordance with the instructions, may cause harmful interference to radio communications. However, there is no guarantee that interference will not occur in a particular installation. If this equipment does cause harmful interference to radio or television reception, which can be determined by turning the equipment off and on, the user is encouraged to try to correct the interference by one or more of the following measures:

- Reorient or relocate the receiving antenna.
- Increase the separation between the equipment and receiver.
- Connect the equipment into an outlet on a circuit different from that to which the receiver is connected.
- Consult the dealer or an experienced radio/TV technician for help.



Changes or modifications not expressly approved by ARRIS for compliance could void the user's authority to operate the equipment.

This device complies with part 15 of the FCC Rules. Operation is subject to the following two conditions: (1) This device may not cause harmful interference, and (2) this device must accept any interference received, including interference that may cause undesired operation.

FCC Declaration of Conformity

ARRIS Enterprises, Inc., 3871 Lakefield Drive, Suwanee, GA 30024, declares that the VMS1100 set-tops comply with 47 CFR Parts 2 and 15 of the FCC rules as a Class B digital device.

Industry Canada (IC) Statement

This Class B digital device complies with Canadian ICES-003.

Cet appareil numérique de la classe B est conforme à la norme NMB-003 du Canada.

CARING FOR THE ENVIRONMENT BY RECYCLING



When you see this symbol on an ARRIS product, do not dispose of the product with residential or commercial waste.

Recycling your ARRIS Equipment

Please do not dispose of this product with your residential or commercial waste. Some countries or regions, such as the European Union, have set up systems to collect and recycle electrical and electronic waste items. Contact your local authorities for information about practices established for your region.

Contents

Safety and Compliance	i
Contents	iv
Tables	vi
Figures	vii
Introduction	1
Product Features	1
Standard Features	2
Whole Home DVR Functionality	3
Getting Help	4
Calling for Repairs	4
Product Overview	5
Top & Front Panels	5
Rear Panel	6
M-Card™	7
System Components Overview	7
Passive Optical Network (PON) Overview	7
Whole Home IP Video Customer Premises Network—Embedded MoCA BHR	9
MoCA	10
Media Server Configurations	11
Installation	12
Before You Begin	12
Check the Home Coaxial Network Topology	13
Video Connection Options	14
Audio Connection Options	14
Clear the Hard Drive	15
Connecting to the Optical Network Terminator (ONT)	16
Connecting to the ONT with Embedded MoCA	17
Connecting Homes with Multiple Existing Cable Drops	18
Connecting the Home Router	19
Connecting the Home Router – Embedded MoCA ONT	19
Installation Overview	19
Connecting a High-Definition TV (HDTV) for Video	20
Connecting a High-Definition TV (HDTV) for Audio	21
Connecting a High-Definition TV (HDTV) and an A/V Receiver for Video	22
Connecting a High-Definition TV (HDTV) and an A/V Receiver for Audio	23
Connecting a Standard-Definition TV	24
Connecting a Standard-Definition TV, A/V Receiver, and VCR	25
Auto-Provisioning	26
Starting the Auto-Provisioning Process	26

Sample VMS1100 Self-Test Screens	27
Sample VMS1100 Self-Test Error and Warning Screens	33
Operational Check for the Remote Control	35
Accessing the Basic User Interface (BUI).....	35
Optimizing the High-Definition Settings	36
Additional HDMI Settings	39
Additional Closed Caption Settings	42
Graphics Overlaying the Video	45
Diagnostics	46
Accessing the Diagnostics	46
d0 Diagnostics Main Menu.....	47
d01 General Status	48
d02 Unit Address / Security	51
d03 Code Modules	54
d04 Current Channel Status	61
d05 HTTP Adaptive Video Information	64
d06 In Home Streaming Sessions	66
d07 Audio / Video Status	68
d08 Memory Configuration.....	70
d09 Interface / Port Status.....	71
d10 Current Sessions	75
d11 Connected Home.....	76
MoCA Node Network.....	77
MoCA Tx and Rx Phy Rates	78
MoCA Power and Attenuation Level	80
MoCA Rx Packet Count	81
MoCA Priority QoS.....	82
Ethernet Hardware Configuration	83
Registered Client List (IP Client)	84
DHCP Link Status.....	85
LAN and QoS	86
d12 Purchase / Poll Status	87
d13 IN BAND Status	89
d14 Out-of-Band (OOB) Status	92
d15 DVR/Hard Drive Status	95
d16 WAN Network	98
d17 Keypad Status.....	99
Troubleshooting	100
Definitions, Acronyms and Abbreviations	104

Tables

Table 1 – DVR Recording Time Guidelines	3
Table 2 – ARRIS-authorized Service Centers	4
Table 3 – Top & Front Panel Controls	5
Table 4 – Rear Panel Ports & Connectors	6
Table 5 – FTTP Passive Optical Network Services	8
Table 6 – VMS1100 Video Outputs	14
Table 7 – VMS1100 Audio Outputs	14
Table 8 – ONT1000M Connections	18
Table 9 – Remote Control Test	35
Table 10 – User Settings Fields	37
Table 11 – Additional HDMI Settings Fields	40
Table 12 – Additional Closed Caption Settings Fields	42
Table 13 – General Status Fields (Page 1 of 2)	49
Table 14 – General Status Fields (Page 2 of 2)	50
Table 15 – Unit Address Fields (Page 1 of 2)	52
Table 16 – Separable Security Fields (Page 2 of 2)	52
Table 17 – Code Modules – Host Download Information Fields (Page 1)	56
Table 18 – Code Modules – MRL Information Fields (Page 2)	57
Table 19 – Code Modules – Card Download Fields (Page 3)	58
Table 20 – Code Modules – Host Object Table Fields (Page 4)	58
Table 21 – Current Channel Status- – IB Tuner ID Fields (Pages 1 & 2)	62
Table 22 – HTTP Adaptive Video Information Fields	64
Table 23 – In Home Streaming Sessions – STREAMING-IN Fields (Page 1)	67
Table 24 – In Home Streaming Sessions – STREAMING-OUT Fields (Page 2 (up to 7))	67
Table 25 – Audio / Video Status Fields	68
Table 26 – Memory Configuration Fields	70
Table 27 – Interface Status -DVI/HDMI Fields (Page 1 of 2)	72
Table 28 – User Setting Fields (Page 2 of 2)	73
Table 29 – Current Sessions Field	75
Table 30 – Connected Home Fields	76
Table 31 – Connected Home – MoCA Node Network Fields	77
Table 32 – Connected Home – MoCA Tx and Rx Phy Rates Fields	79
Table 33 – Connected Home – MoCA Power and Attenuation Level Fields	80
Table 34 – Connected Home – MoCA Rx Packet Count Fields	81
Table 35 – Connected Home – MoCA Priority QoS Fields	82
Table 36 – Connected Home – Ethernet Hardware Configuration Fields	83
Table 37 – Connected Home – Registered Client List Fields	84
Table 38 – Connected Home – DHCP Link Status Fields	85
Table 39 – Connected Home – LAN and QoS Fields	86
Table 40 – Purchase / Poll Status Fields	88
Table 41 – In Band Status Fields (Page 1)	90

Table 42 – In Band Status Fields (Page 2)	91
Table 43 – Out-of-Band Status Fields	92
Table 44 – DVR Status Fields (Page 1 of 3)	96
Table 45 – Hard Drive Partitions Fields (Pages 2 & 3)	97
Table 46 – WAN Network Fields	98
Table 47 – Keypad Status Fields.....	99
Table 48 – Troubleshooting Guidelines.....	100
Table 49 – Definitions, Acronyms and Abbreviations	104

Figures

Figure 1 – Typical VMS1100 Whole Home IP Video Network Solution	1
Figure 2 – VMS1100 Front View.....	5
Figure 3 – VMS1100 Rear View.....	6
Figure 4 – PON Overview.....	8
Figure 5 – Whole Home IP Video CPE Overview	9
Figure 6 – MoCA RF Spectrum.....	10
Figure 7 – Set-Top Box MAC Address.....	13
Figure 8 – Basic User Interface (BUI) Main Menu.....	15
Figure 9 – Connecting to the ONT1000.....	16
Figure 10 – Connecting to the ONT1000M	17
Figure 11 – High-Definition TV (HDTV) for Video Connection	20
Figure 12 – High-Definition TV (HDTV) for Audio Connection	21
Figure 13 – High-Definition TV (HDTV) and an A/V Receiver for Video Connection	22
Figure 14 – High-Definition TV (HDTV) and an A/V Receiver for Audio Connection	23
Figure 15 – Standard-Definition TV Connection.....	24
Figure 16 – Standard-Definition TV, A/V Receiver, and VCR Connection	25
Figure 17 – Welcome Screen	27
Figure 18 – Welcome-Start Activation Screen.....	27
Figure 19 – Sample Welcome-Start Activation Error Screen.....	28
Figure 20 – Step 1:-Coax Connection Test Screen (1 of 5).....	28
Figure 21 – Step 1:-Coax Connection Test Screen (2 of 5).....	29
Figure 22 – Step 1: Sample Coax Connection Warning Screen (3 of 5)	29
Figure 23 – Step 1: Step 1: Sample Coax Connection Error Screen (4 of 5)	30
Figure 24 – Step 1: Coax Connection Test Screen n (5 of 5)	30
Figure 25 – Step 2: Software Download Test Screen (1 of 3)	31
Figure 26 – Step 2: Software Download Test Screen (2 of 3)	31
Figure 27 – Step 2: Software Download Test Screen (3 of 3)	32
Figure 28 – Step 3: Activation Screen	32
Figure 29 – Activation Complete Screen	33
Figure 30 – Basic User Interface (BUI) Main Menu.....	36
Figure 31 – User Settings Screen.....	37

Figure 32 – Additional HDMI Settings Screen	39
Figure 33 – Diagnostics Main Menu	47

1

Introduction

This manual is intended for system operator personnel to provide instructions for installing and configuring the ARRIS VMS1100 High-Definition Video Media Server and other entertainment devices in the home.

Product Features

The VMS1100 HD Video Media Server is an advanced whole home solution for viewing entertainment in the home. It is a media server that includes multiple QAM tuners, a high-end processor, expanded memory, and enhanced graphics to support delivery of digital, on-demand, and interactive services throughout the entire home. The VMS1100 provides a full complement of interconnection options. This device not only allows for streaming media content, but also uses smaller, more energy-efficient IP client set-top boxes (STBs). The VMS1100 communicates with the IPC1100 client set-top boxes (STBs) each connected to a TV. The following graphic depicts a sample VMS1100 whole home entertainment solution:

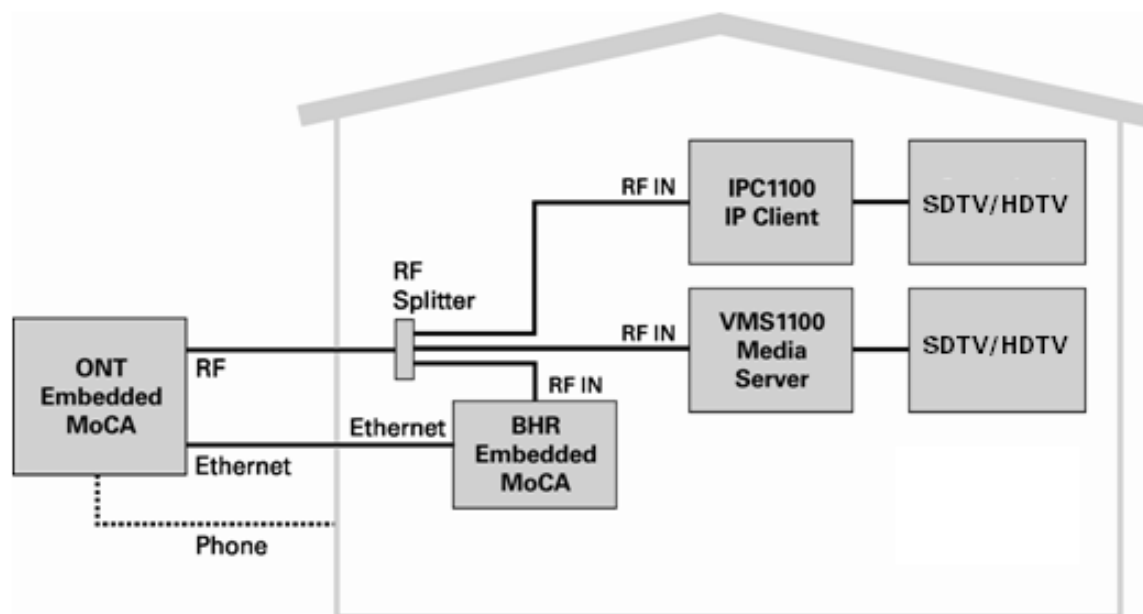

Figure 1 – Typical VMS1100 Whole Home IP Video Network Solution

The VMS1100 provides the following advanced functionality:

- Whole home DVR support for up to four connected IP Client set-top boxes
- Authorization and purchase of on-demand programming
- High-Definition television (HDTV) video decoding
- HDTV output through component video (YPbPr) or High-Definition Multimedia Interface™ (HDMI™)
- Surround-sound audio through a variety of analog and digital interconnection options
- Live playback and LOD buffering capabilities to pause and time shift live video and seamlessly record for all connected televisions
- Built-in MoCA 1.1/2.0 HW support

As with all ARRIS digital set-tops, the hardware features are enabled by core operating and third-party application software.

Standard Features

- Six 54 to 864 MHz video tuners with digital video processor
- One dedicated tuner for the out-of-band (OOB) control channel
- ITU standard 64/256 QAM/FEC/enhanced adaptive equalizer
- CSA based encryption/DCII (via inserted CableCARD™) access control
- Out-of-band data receiver (70-130 MHz) 2.048 Mbps
- Digital video scaling (picture in graphics)
- Macrovision® copy protection
- High-definition video output through:
 - HDMI (also compatible with DVI using an HDMI-to-DVI converter cable)
 - Component Video (YPbPr)
- Standard-definition video output through Baseband (Composite)
- Audio output through:
 - Digital audio (S/PDIF) ATSC standard Dolby® Digital optical
 - Baseband L/R

Whole Home DVR Functionality

- Integrated MoCA 1.1/2.0 hardware supporting IP streaming and two-way connectivity to as many as four connected clients
- DVR functionality integrated with the IPG enables all connected clients to do the following:
 - Pause, rewind, fast-forward, or record FiOS TV
 - Initiate program recordings and access the recordings library
 - Select programs to record across multiple channels and time slots
 - Rewind and replay recorded programs
 - Record multiple programs in the background while viewing another live program

Note: ARRIS cannot guarantee the exact amount of programming that each subscriber will be able to record. The approximate time depends on the programming type and the encoding format used (see below):

Table 1 – DVR Recording Time Guidelines

INTERNAL DRIVE SIZE	ESTIMATED RECORDING HOURS FOR:	
	STANDARD DIGITAL CHANNELS	HDTV CHANNELS
1 TB	350 to 444	90 to 150

All times are approximate. The actual hours a subscriber can record are a function of program bit rate, the IPG type, and the reserved buffer space.

Standard Data Features

- 1 GB flash memory
- 2 GB SDRAM
- One rear Universal Serial Bus (USB) 2.0 port
- 10/100/1000 Mbps Ethernet Port (RJ-45)

Standard Miscellaneous Features

- Messaging capabilities
- Digital diagnostics
- Four-digit, seven-segment LED display

Getting Help

For help with your ARRIS product, you can contact the **Technical Assistance Center (TAC)** either by telephone, online, or email:

- Telephone call: **888-944-HELP (888-944-4357)** or **1-215-323-2345**
- Website: <http://moto.force.com/customer-care360>
- Email: Tac.Helpdesk@ARRISI.com

Calling for Repairs

If an ARRIS set-top box requires repair service, please call one of the following ARRIS-authorized Service Centers:

Table 2 – ARRIS-authorized Service Centers

COMPANY	FROM USA OR CANADA	OUTSIDE USA OR CANADA
World Wide Digital	1-800-227-0450	1-956-541-0600
Teleplan	1-800-352-5274	1-302-322-6088

Please contact the ARRIS Technical Assistance Center (TAC) at **888-944-4357** (direct dial: **847-725-4011**) for assistance in verifying that repair is necessary. The TAC will create an RSA for repair or an RA for replacement if equipment qualifies.

The RSA number must be prominently displayed on all equipment cartons. To ensure efficient service, request a Return for Service Authorization (RSA) number. Be sure to display the RSA number prominently on all equipment boxes.

The Service Center will provide the shipping address of the location performing your repairs.

Do the following to ship your equipment for repair:

1. Pack the unit securely, if possible in its original factory shipping carton.
2. Print or display the RSA number so it is easily visible on all equipment boxes.
3. Enclose a note describing the exact problem. Complete and enclose the checklist provided with the unit.
4. Ship the unit **PREPAID** to the address provided by the Service Center.

2

Product Overview

Top & Front Panels

The VMS1100 top panel controls provide functional navigation if the remote control is not available or temporarily out of service.

The VMS1100 front panel provides the mechanical **Power/Standby** button and the **LED Clock/Channel number** display. A USB 2.0 port is provided, though some USB connectors are not enabled and require the support of application software.



Figure 2 – VMS1100 Front View

Table 3 – Top & Front Panel Controls

BUTTON/PORT	DESCRIPTION
1 Power button	Turns ON/OFF power to the media server
2 OK button	Selects or confirms the current onscreen option
3 Cursor buttons	Navigates the onscreen menus
4 USB 2.0 Port*	Connects to a high-speed peripheral device
5 Display Panel	Shows the time or channel number
6 Display Icons	Message, Recording, Home Network, Software Update

*This option may not be enabled.

Rear Panel

The VMS1100 rear panel contains ports and connectors for video, audio, RF cabling, data output, and data interface. Some connectors are not enabled and require application software support.

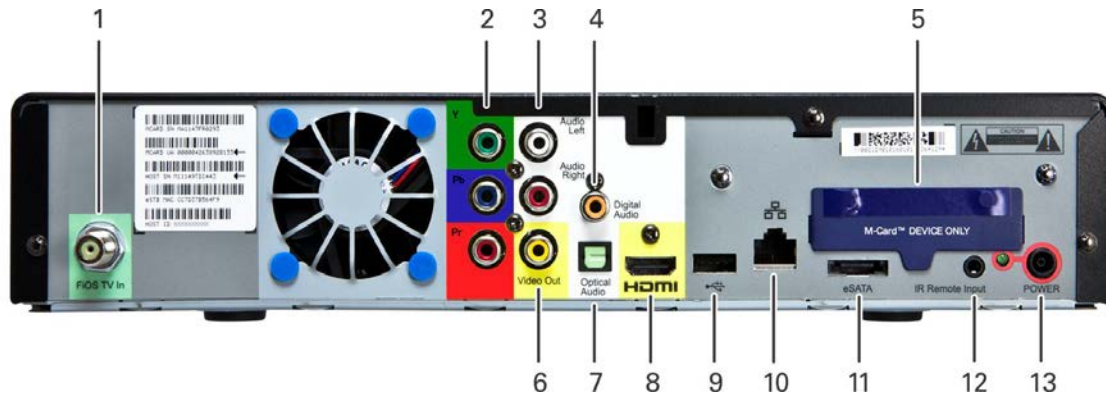

Figure 3 – VMS1100 Rear View

Table 4 – Rear Panel Ports & Connectors

PORT/CONNECTOR	DESCRIPTION
1 FiOS TV In	Connects to a coaxial cable that delivers the FiOS signal from your service provider
2 YPbPr	Connects to the color-coded component video input on a high-definition TV (HDTV)
3 Audio	Connects to the analog audio left/right stereo inputs on a TV
4 Digital Audio (RCA)*	Connects to the Dolby® Digital 5.1 audio or PCM output on a digital audio device
5 M-Card Device Only	Cable card access panel. The M-CARD is required to view television programs, previously recorded programs on the DVR, or interactive on-demand programs. The M-CARD should not be removed.
6 Video Out	Connects to the standard definition video output on an SDTV or VCR
7 Optical Audio*	Connects to the Dolby® Digital 5.1 audio or PCM output on a digital audio device
8 HDMI	Connects to a high-definition TV (HDTV)
9 USB 2.0*	Connects to a high-speed peripheral device

PORT/CONNECTOR	DESCRIPTION
10 Ethernet*	Connects to an Ethernet device
11 eSATA*	Connects to an external Serial ATA hard disk drive
12 IR Remote Input	Connects to a remote control set-top accessory cable
13 Power	Connects the power cord to the VMS1100

*This option is dependent upon application setting and availability in content.

M-Card™

The MCARD is required to view television programs or interactive on-demand programs. The MCARD should not be removed.

System Components Overview

This section introduces key concepts relevant to installing the ARRIS Whole Home IP Video Network CPE. It describes the following:

- The passive optical network (PON) connecting the customer premises to the headend
- The ARRIS Whole Home IP Video Network that you install at the customer premises
- Multimedia Over Coax Alliance (MoCA) technology
- Multi-room DVR

The ARRIS Whole Home IP Video Network connects to the fiber-to-the-premises (FTTP) passive optical network (PON). It uses MoCA technology to provide an integrated Ethernet, IP, and coaxial radio frequency (RF) network. This network enables the delivery of services such as interactive video, high-speed data, and IP telephony to residential and small business customers using existing RF coaxial cabling.

Passive Optical Network (PON) Overview

A PON is a fiber optic network capable of carrying a high volume of traffic over a single fiber. The same fiber carries data:

- *Downstream* from the optical line terminator (OLT) at the headend to the optical network terminator (ONT) at the customer premises
- *Upstream* from the ONT back to the headend (also referred to as the return path)

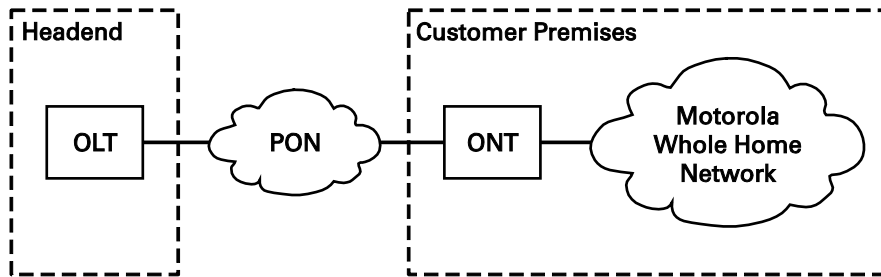

Figure 4 – PON Overview

Table 5 – FTTP Passive Optical Network Services

SERVICE	DESCRIPTION
<p>Two-way video service</p>	<p>Video services include enhanced interactive services such as video on demand (VoD). Video is carried over the PON to the ONT and then over the in home coaxial network. Digital and out of band (OOB) carriers are supported on the 50 to 862 MHz spectrum.</p> <p>Video traffic on the PON consists of:</p> <ul style="list-style-type: none"> • Downstream digital standard and high-definition television (HDTV) video services; for example, local broadcast channels, Disney®, ESPN®, and other services. • Downstream IP data; for example, streaming VoD channels. • Upstream IP data; for example, VoD purchase data. • The ARRIS MediaCipher® conditional access system, which provides subscription, event, firmware download, and set top terminal management; performs real time encryption for broadcast programs and pre encryption for VoD content; and uses the OOB RF downstream channel for all control and management functions. • Standard and high definition VoD services are delivered using constant bit rate MPEG 2 or MPEG-4 single program transport streams. The MPEG 2/MPEG-4 video is transported in User Datagram Protocol (UDP) packets addressed to the set top that are metered to avoid congestion. <p>All return communication is through IP.</p>
<p>High-speed data service</p>	<p>The PON provides data service using the same management infrastructure as digital subscriber loop (DSL) service</p>
<p>Telephony</p>	<p>A separate private virtual circuit carries telephone service over the PON.</p>

Whole Home IP Video Customer Premises Network—Embedded MoCA BHR

The ARRIS Whole Home IP Video Network carries the following over coaxial cable:

- Video QAM MPEG-2 or MPEG-4 encoded broadcast services over the full 50 to 864 MHz spectrum for MoCA 1.1 BHRs and the 1350 to 1675 MHz spectrum for MoCA 2.0 BHRs
- IP over coaxial for interactive traffic and VoD Streaming over the 975 to 1025 MHz spectrum

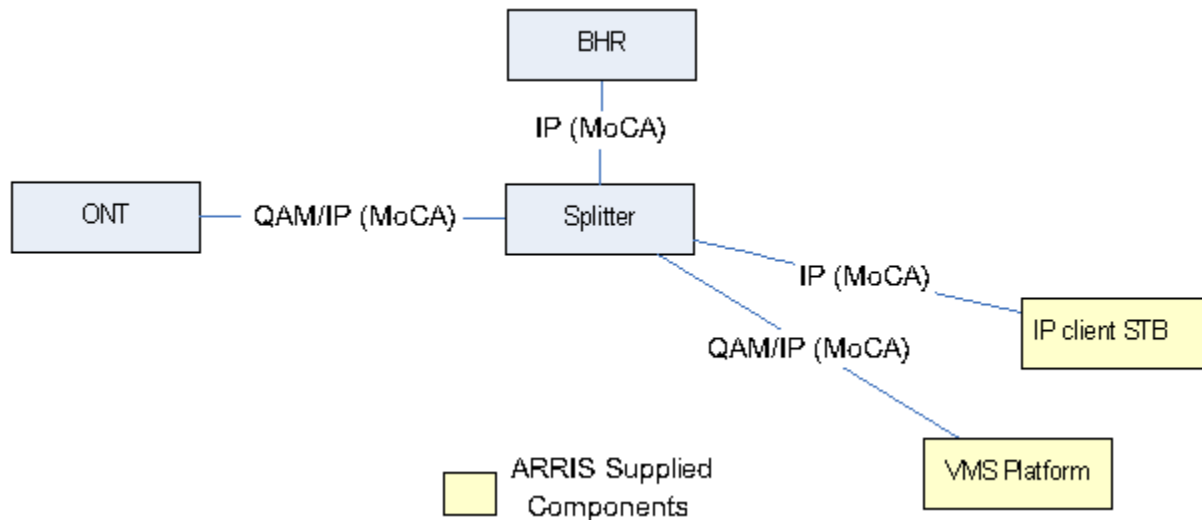

Figure 5 – Whole Home IP Video CPE Overview

The components include:

- ARRIS or similar optical network
- Broadband Home Router (BHR) with embedded MoCA
- VMS1100 advanced digital media server supporting HDTV and digital video recording (DVR)
- IPC1100 high-definition IP Client set-tops supporting HDTV

Note: You must connect the BHR to an RF coaxial splitter connected to the coaxial cable wall outlets in the other rooms on the customer's premises.

MoCA

MoCA technology bridges Ethernet traffic onto the coaxial cable network. MoCA 2.0 operates from the following frequencies:

- 975 to 1025 MHz on the MoCA WAN channel when a MoCA 1.1 BHR is present
- 1125 to 1175 MHz on the MoCA LAN channel when communicating with MoCA 1.x devices
- 1125 to 1225 MHz on the MoCA LAN channel when communicating with any MoCA 2.0 devices
- 1350 to 1675 MHz on the MoCA WAN channel when a MoCA 2.0 BHR is present

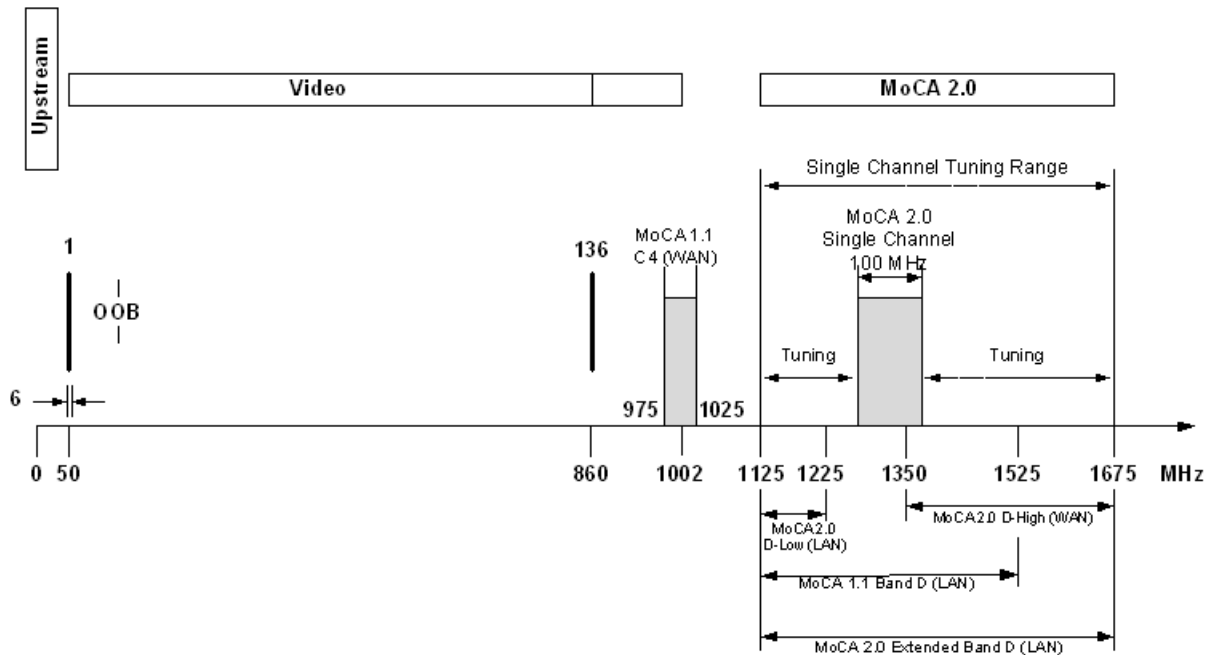

Figure 6 – MoCA RF Spectrum

Each MoCA set-top requires an IP address for configuration and management, but do not require any other IP services. To minimize network IP address requirements, the MoCA uses the Link-Local IP address space.

Link-Local IP addressing enables MoCA set-tops to operate on a private local area network (LAN) using a defined range of reserved IP addresses. The MoCA set-tops in a home automatically self-assign an IP address in the range above **169.254.1.18**.

The Link-Local address space is registered with the Internet Assigned Numbers Authority (IANA). For detailed information about Link-Local addressing, visit www.faqs.org/rfcs/rfc3927.html.

Media Server Configurations

The VMS1100 is intended to operate in homes with two or more televisions or video output screens. In multi-screen households, the VMS1100 acts as a video services gateway, providing connectivity to the service provider's network and handling subscription security, content decryption, channel tuning and program recording and playback capabilities for all the other screens connected to the home network.

Single VMS Configuration

The VMS1100 can function as a video media server for one directly connected television and up to four additional TVs connected to the home's coaxial wiring through a IP Client set top like the IPC1100. In this configuration, the VMS1100 performs the heavy lifting of tuning the QAM services, decoding the encrypted signal, and processing any code download or subscription security transactions. Video content is then passed from the through the home network to connected clients as IP traffic streams.

Though they are in fact utilizing the hardware resources of the VMS, each IP Client can display the IMG, tune channels, pause/resume live television, initiate recordings or playback recorded content independently.

Multiple VMS Configuration

Households with more than five televisions will require more than one VMS1100 to be installed.

3

Installation

This section provides instructions for connecting and configuring the VMS1100 in a multi-television screen household. The VMS1100 supports an auto-provisioning feature that automates many of the tasks required to configure and provision the in-home IP video components.

The installation will include the following series of steps:

- Connecting to the Optical Network Terminator (ONT)
- Connecting the home router
- Connecting the RF coaxial cable to the RF connector in on each set-top
- Connecting the A/V connections for each set top to the home theater equipment
- Performing the Auto-Provisioning procedures from the VMS1100 On-screen menu
- Optimize the high definition settings

Before You Begin

Before you move or change components on the subscriber's entertainment system, do the following:

- Make sure you have all the required tools and equipment.
- Review the installation instructions.
- Check the home coaxial topology.
 - Make sure no cable network or satellite dish is connected.
 - Make sure there are no amplifiers that could interfere with the MoCA network.
 - Determine the numbers and type of splitters used.
 - Verify that the signal at each coaxial outlet you will use is in the range -10 to +10 dBmV.
 - If necessary, replace or move amplifiers or splitters.
- Check the home entertainment system. Determine if you are connecting to one of the following:
 - Standard-Definition analog NTSC TV (supporting RF input)
 - Baseband Composite video or S-Video
 - High-Definition TV (Component video, HDMI, or DVI)
- Determine if the subscriber has other equipment to be connected to the terminal (Home Theater or A/V receiver, VCR, etc.). Verify that you have the necessary cables and other required items.
- Have the customer specify where the VMS1100 media server should be installed.

Note: Make sure to install the VMS1100 media server **before** connecting any other set-tops.
- Write down the MAC address and serial number for each VMS1100 and IP Client set-top box. The labels are located on the bottom of the devices.



Figure 7 – Set-Top Box MAC Address

Check the Home Coaxial Network Topology

This procedure assumes you are networking at least one VMS1100 and one or more IP Client STBs. Before you install the VMS1100, do the following:

1. Create a table listing for each of the following:
2. Every room where you plan to install a set top.
3. The signal levels you measured at the RF cable outlets.
4. HFC MAC Address located on the label on the bottom of the set-top used in that room.
5. Optionally, you can include information such as the set top type, serial numbers, and anything else you or the service provider considers useful.
6. Use your TV signal tester at the coaxial outlet where you will connect any MoCA set-top box and router. Verify that the signal level of the highest downstream digital channel frequency is between -10 and 10 dBmV. Record your readings in a table similar to Table 4-1. A signal level of +0 dBmV is ideal.

Note: *If the signal level is less than -10 dBmV, you must correct the problem before installing the set-top box.*

7. If possible, determine whether there are one or more in-line coaxial RF amplifiers. If possible, move the existing amplifier to a position near the point of entry. See [Troubleshooting](#) for more information.
8. If possible, determine how many splitters, and what kind, are in use. An older splitter, such as an old eight-way splitter, may have unacceptably high throughput loss. Replace any splitter cascades having a loss of 18 dB or more.
9. If the signal level at one or more coaxial outputs remains unacceptably low, the power loss may be caused by long coaxial cable runs using cable of insufficient quality. For example, a 330 ft (100 m) cable can reduce the power by 20 to 27 dB, depending on the cable quality. This results in a very low power level at the outlet of about -5 to -10 dBmV or lower. This loss, combined with loss from a splitter, causes marginal MoCA network performance.
10. If you make any changes to the network, repeat steps 1 and 2.



Be sure all connections are properly secured. Poor F-connector fittings or poor grounding can cause ingress.

Video Connection Options

Use the following guidelines to determine the best video connection for the subscriber's home entertainment system. To determine the available video inputs on the TV, check the manual supplied with the TV or the TV itself.

The VMS1100 offers the following video outputs:

Table 6 – VMS1100 Video Outputs

CONNECTION TYPE	TV TYPE	DESCRIPTION
Component (YPbPr)	HDTV and SDTV	The YPbPr outputs provide component video, the most widely supported HD video connection.
HDMI or IEEE-1394	HDTV and SDTV	<ul style="list-style-type: none"> HDMI and IEEE-1394 offer higher quality HD video than component video. If the TV has an HDMI or a DVI input, use the HDMI output instead of the IEEE-1394 output. HDMI and IEEE-1394 are video and audio connections. If you use HDMI or IEEE-1394, no separate audio connection to the TV is required. HDMI is compatible with DVI. If the TV has a DVI input, you can use an HDMI-to-DVI converter cable or adapter to connect to the VMS1100 HDMI connector. If you use IEEE-1394, on-screen graphics do not display.
Video (Composite)	SDTV only	If the TV does not have an S-Video input, use the composite video output (video).

Audio Connection Options

When connecting to a home theater receiver, depending on its inputs, you can use the following VMS1100 audio outputs:

Table 7 – VMS1100 Audio Outputs

CONNECTION TYPE	DESCRIPTION
Digital audio optical (S/PDIF) or digital audio coaxial (RCA)	<p>If the receiver supports it, use the digital audio optical (S/PDIF) or digital audio coaxial (RCA) audio output to deliver Dolby Digital audio to a Dolby Digital home theater receiver.</p> <p>Audio is available via HDMI and no further audio connection is required. For RF output, no further audio connection is required.</p>
Baseband Audio L and R	If the audio receiver does not support Dolby Digital, use the baseband AUDIO L and R outputs to connect to the audio receiver.

Connect the stereo audio cable to the audio l and r connectors on the VMS1100 series and the audio left and right connectors on the TV. If the equipment supports it, use the optical S/PDIF or coaxial digital RCA output instead of the audio l and r outputs. In most cases, these outputs offer better audio quality, including support for 5.1 Surround Sound. The cabling diagrams show sample audio/video (A/V) connections to an audio receiver, where the receiver functions as an A/V router.

When connecting to an audio receiver, reference its installation instructions for directions on connecting to baseband and digital (S/PDIF) audio ports.

Note: The VCR and TV receive their A/V signals from the currently selected input device on the audio receiver. This is important when the subscriber has another A/V device such as a DVD player, a secondary VCR, a CD player, or other electronic component. We recommend connecting the TV to the monitor output so onscreen menus for the receiver can be displayed. (In many cases, the receivers themselves have interactive onscreen menus.)

Clear the Hard Drive

If you are installing a previously used VMS1100, delete all recorded programs from the hard drive before completing the installation at a new subscriber location. This prevents your new subscriber from viewing programming they may not have purchased or may not want to see.

Do the following to clear the VMS1100 hard drive:

1. Connect the AC power on the VMS1100.
2. Press the **D** key on the IR remote control immediately after the VMS1100 front panel **8888** indicators dim. The BUI main menu displays.

Note: There may be a one minute delay while the application boots up before the BUI menu displays.



Figure 8 – Basic User Interface (BUI) Main Menu

3. Select **01 Diagnostics** from the BUI main menu to start the onscreen diagnostics. See [Accessing the Basic User Interface \(BUI\)](#) for more information.
4. Within five seconds, press **DVR** three times, and **FiOS TV** on the IR remote control.

Note: On some remote controls, the **DVR** key may be labeled as **list**.

- o If successful, the hard drive is cleared and **Clr** is displayed on the front panel. Press any other key to reset the terminal and turn it OFF to complete the clearing process.
- o If **Clr** is not displayed, repeat step 4.

Connecting to the Optical Network Terminator (ONT)

If necessary, connect to the ONT to the home coaxial network. This example shows connecting the ARRIS ONT1000 model which does not have embedded Multimedia over Coax Alliance (MoCA) technology.



Make sure the coaxial cabling on the customer premises is not connected to any digital network or satellite dish.

Determine how to route the coaxial and Ethernet cables from the ONT into the home. You may need to move an existing cable drop from its present location to where the ONT is mounted.

To connect to the ARRIS ONT1000, do the following:

1. Open the door.
2. Connect the customer's premises coaxial cable wiring to the CABLE OUT port.
3. Connect the customer's premises Ethernet cabling to the ETHERNET port.
4. If necessary, route the coaxial and Ethernet cables into the house.
5. Close the ONT door and secure the ONT.

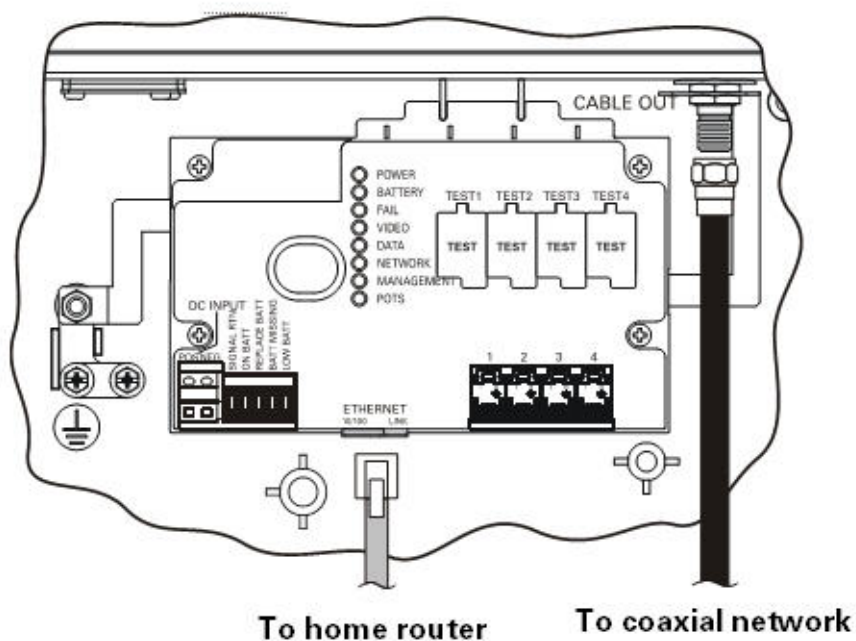

Figure 9 – Connecting to the ONT1000

Connecting to the ONT with Embedded MoCA

If necessary, connect to the ONT to the home coaxial network. This example shows connecting the ARRIS ONT1000M with embedded Multimedia over Coax Alliance (MoCA) technology.



Make sure the coaxial cabling on the customer premises is not connected to any digital network or satellite dish.

Determine how to route the coaxial and Ethernet cables from the ONT into the home. You may need to move an existing cable drop from its present location to where the ONT is mounted.

To connect to the ARRIS ONT1000M:

- Open the door.
- Connect the customer's premises coaxial cable wiring to the CABLE OUT port.
- If necessary, route the coaxial cables into the house.
- Replace the lower half enclosure and secure the ONT1000M.

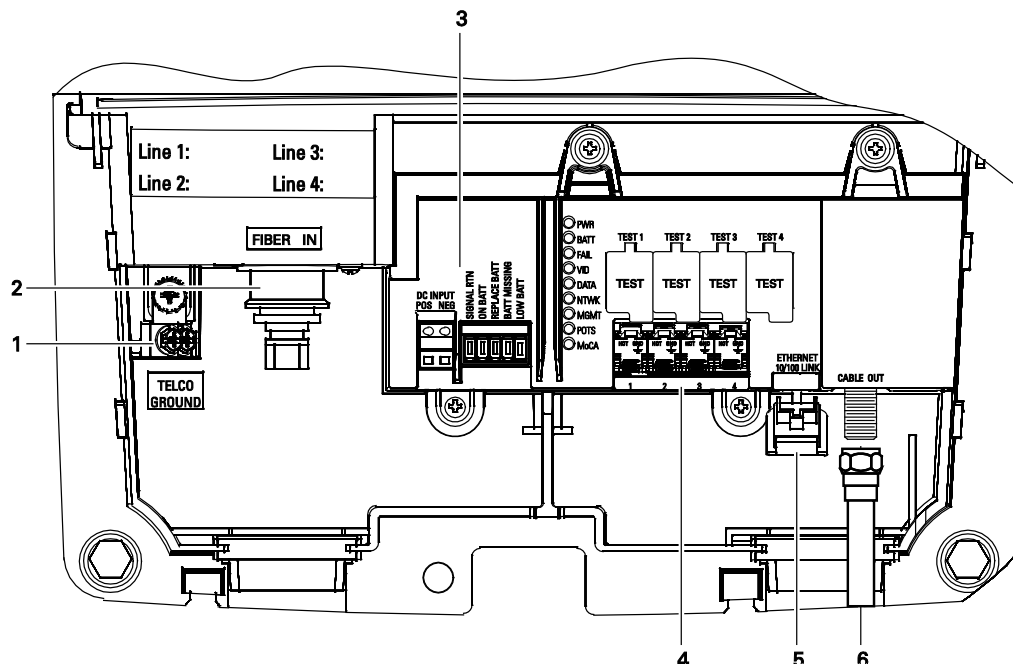

Figure 10 – Connecting to the ONT1000M

Table 8 – ONT1000M Connections

KEY	NAME	DESCRIPTION
1	Telco ground terminal	Connects the ONT1000M and the subscriber's telephone, data, and cable TV wiring networks to protective ground at the electrical service ground electrode.
2	Fiber in	OptiFit connector provides input to the ONT1000M from the PON network.
3	UPS input terminal strip	<ul style="list-style-type: none"> Connects the ONT1000M to an external Uninterruptible Power Supply (UPS), as follows: POS — connects to the +12 VDC output terminal on the external power supply (UPS). NEG — connects to the –RTN output terminal on the external power supply (UPS). Signal RTN — connects to the SIG RTN output terminal on the external power supply (UPS). ON BATT — ONT1000M is operating off of the battery. Connects to the ON BATT terminal on the UPS. REPLACE BATT — battery present but not operational. Connects to the BATT MISSING terminal on the UPS. LOW BATT — battery low, needs changing. Connects to the LOW BATT terminal on the UPS. Using a UPS is optional for a network-powered ONT1000M.
4	Telephone terminal strip	<ul style="list-style-type: none"> Termination point for subscriber's telephone lines. These are insulation displacement type connectors (IDCs) and serve as input for four separate lines.
5	Ethernet connection	<ul style="list-style-type: none"> RJ-45 Ethernet high-speed data connection to the subscriber's computer.
6	Cable out	Cable TV output for distribution of video services to the customer premises.

Connecting Homes with Multiple Existing Cable Drops

Some customer premises may have multiple coaxial inputs from one or more taps, typically entering different locations in the home. For the PON, it is practical to have one connection only per customer premises. You must use a splitter and cabling to connect any additional drops to the ONT. The routing will depend on the layout of the home and customer preference.

Connecting the Home Router

To connect the home router:

1. Connect the Ethernet cable you routed from the ONT to the WAN Ethernet port on the home router.
2. Make sure the router is powered ON.
3. Enable Dynamic Host Configuration Protocol (DHCP) on the router. Follow the instructions provided with the router.

Connecting the Home Router – Embedded MoCA ONT

To connect the home router:

1. Connect the coaxial cable you routed from the ONT to the coax/MoCA port on the home router.
2. Make sure the router is powered ON.
3. Enable Dynamic Host Configuration Protocol (DHCP) on the router. Follow the instructions provided with the router.

Installation Overview

1. Determine if you are connecting to one of the following:
 - a. **High-Definition TV or monitor** - Use the HDMI or component video (YPbPr) output. No other video connection supports HDTV.
If the TV has no HDMI input but does have a DVI input, connect a DVI-to-HDMI adapter or cable to the HDMI out connector on the VMS set-top and the DVI-HDTV connector on your TV.
 - b. **Standard-Definition TV** - Connect the composite video connector using a composite (RCA phono) cable.
2. Determine if you are connecting the audio to a home theater receiver or directly to the TV:
 - a. For an HDMI video connection, no additional audio connections to the TV are required.
 - b. For a DVI video connection, additional audio connections to the TV are required.
 - c. If the receiver or TV has a digital audio (S/PDIF) input, use the Optical Audio (S/PDIF) or Digital Audio (Coaxial) outputs. Otherwise, use the baseband left and right audio outputs.
3. Locate the cabling diagram(s) that best match your planned configuration.
4. Connect the audio and video cables as shown in the diagram you are using.
5. Determine if you are connecting to a data device. For installation details, refer to the instructions included with the data device.
6. Connect the FiOS TV In terminal to the coaxial cable wall outlet.
7. Perform the operational check for the remote control.
8. Optimize the high-definition settings (see [Optimizing the High Definition Settings](#)).

Connecting a High-Definition TV (HDTV) for Video

Do the following for the best possible HDTV video quality:

1. If the TV has an HDMI input, connect it to the HDMI output on the VMS1100.
2. If the TV has a DVI input, connect it to the HDMI output on the VMS1100 using an HDMI-to-DVI converter cable or adapter.
3. Otherwise, use the component video (Y, Pb, and Pr) connectors. L/R audio connection or digital audio S/PDIF connection is required for sound with component video.

Note: Make sure to match up each signal to the same connection on the TV or the colors will not appear correctly on the TV.

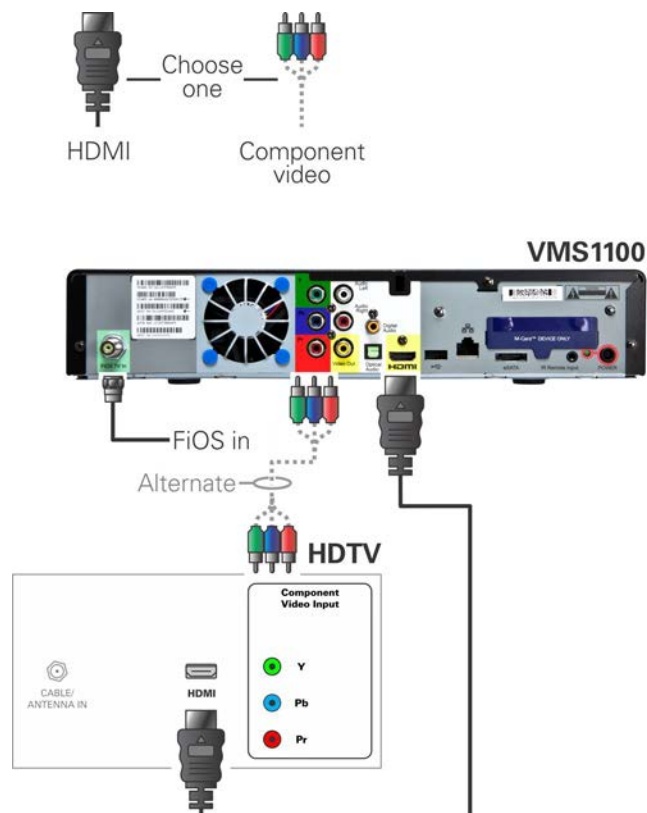

Figure 11 – High-Definition TV (HDTV) for Video Connection

Note: Because HDMI provides both video and audio output, no additional audio connections to the TV are required.

Connecting a High-Definition TV (HDTV) for Audio

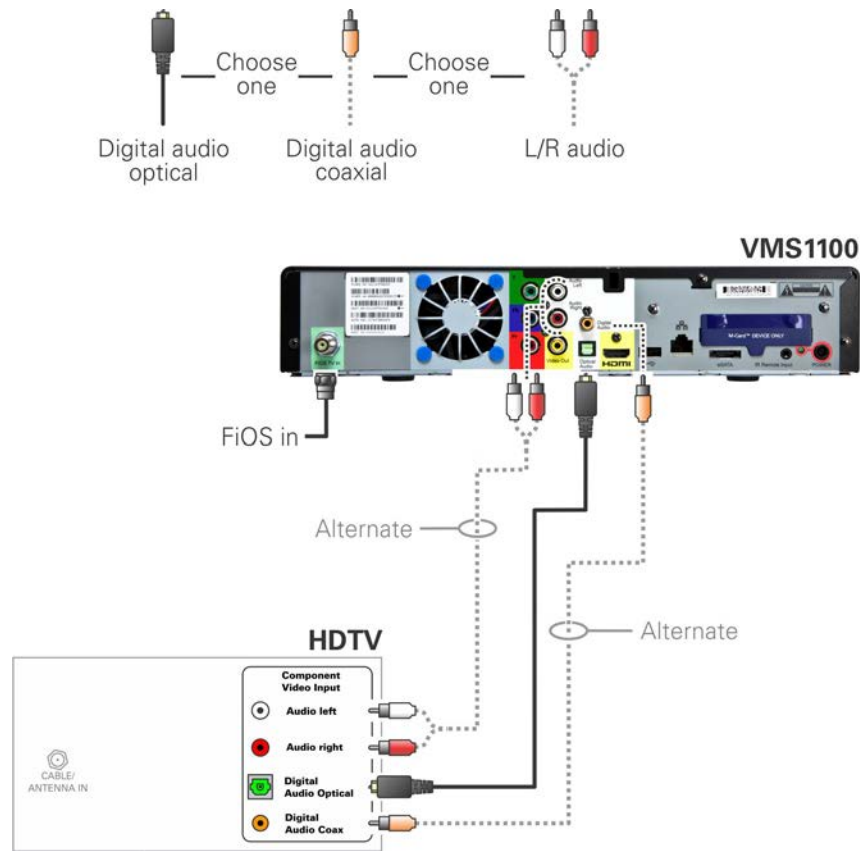

Figure 12 – High-Definition TV (HDTV) for Audio Connection

Connecting a High-Definition TV (HDTV) and an A/V Receiver for Video

Note: If the A/V receiver includes an HDMI input and output, the VMS1100's HDMI output can be connected directly to the A/V receiver's input and the A/V receiver's HDMI output directly to the TV. Because HDMI provides both video and audio output, no additional audio connections to the A/V Receiver and TV are required.

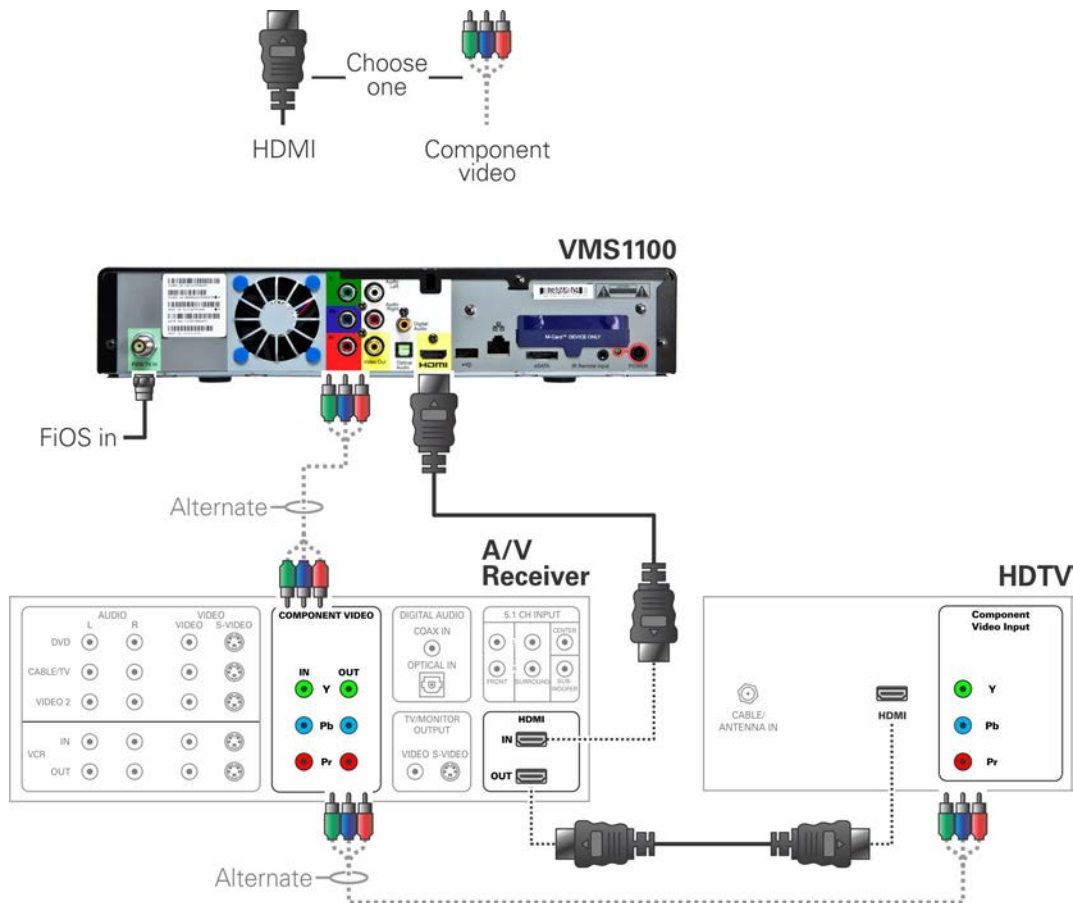

Figure 13 – High-Definition TV (HDTV) and an A/V Receiver for Video Connection

Connecting a High-Definition TV (HDTV) and an A/V Receiver for Audio

Note: If the A/V receiver includes an HDMI input and output, the VMS1100's HDMI output can be connected directly to the A/V receiver's input and the A/V receiver's HDMI output directly to the TV. Because HDMI provides both video and audio output, no additional audio connections to the A/V Receiver and TV are required.

Note: If the receiver can check the baseband and digital audio (S/PDIF) ports for appropriate channels, connect both the baseband and digital audio connections. Otherwise, do not connect both the baseband left/right composite connections and the coaxial digital connection. The baseband connections are not necessary because the digital audio port provides a single audio interface for digital and analog channels.

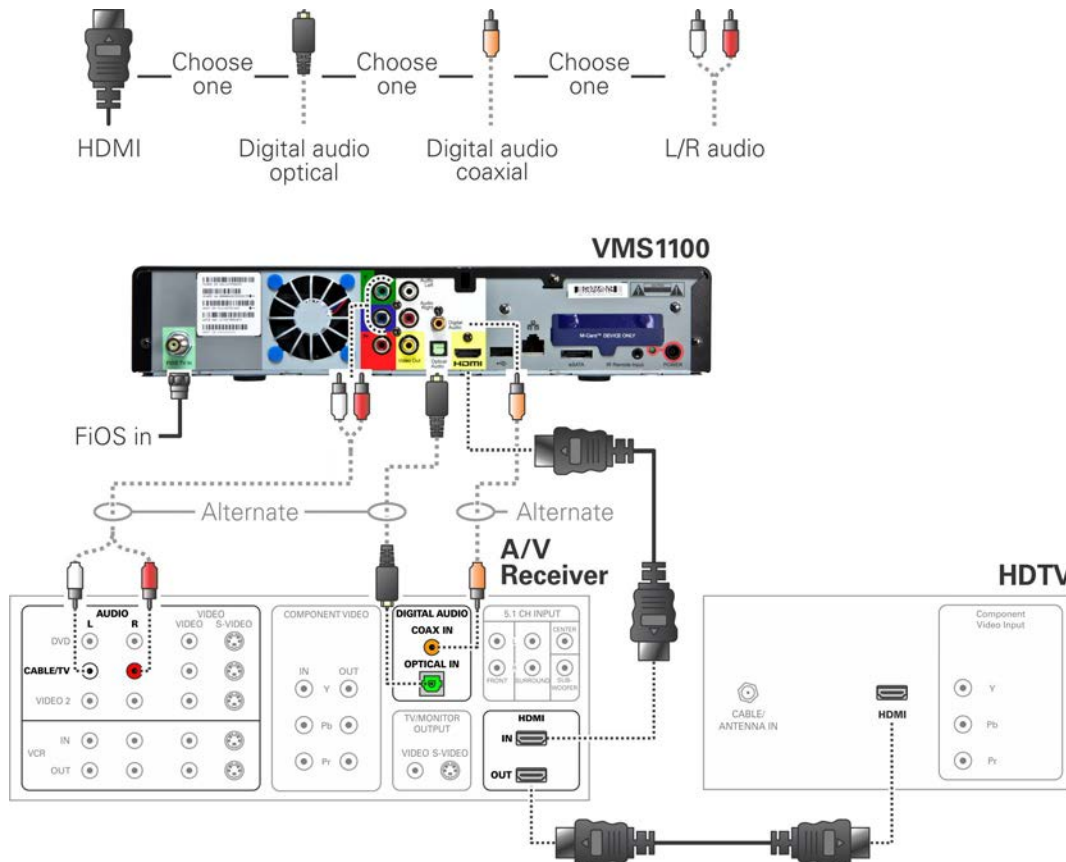

Figure 14 – High-Definition TV (HDTV) and an A/V Receiver for Audio Connection

Connecting a Standard-Definition TV

1. Connect the stereo audio cable to the audio L or R connector on the VMS1100 and the audio left and audio right connectors on the SDTV.
2. If the TV has an HDMI input, connect it to the HDMI output on the VMS1100.
3. If the TV has a DVI input, you can connect it to the HDMI output on the VMS1100 using an HDMI-to-DVI converter cable or adapter.

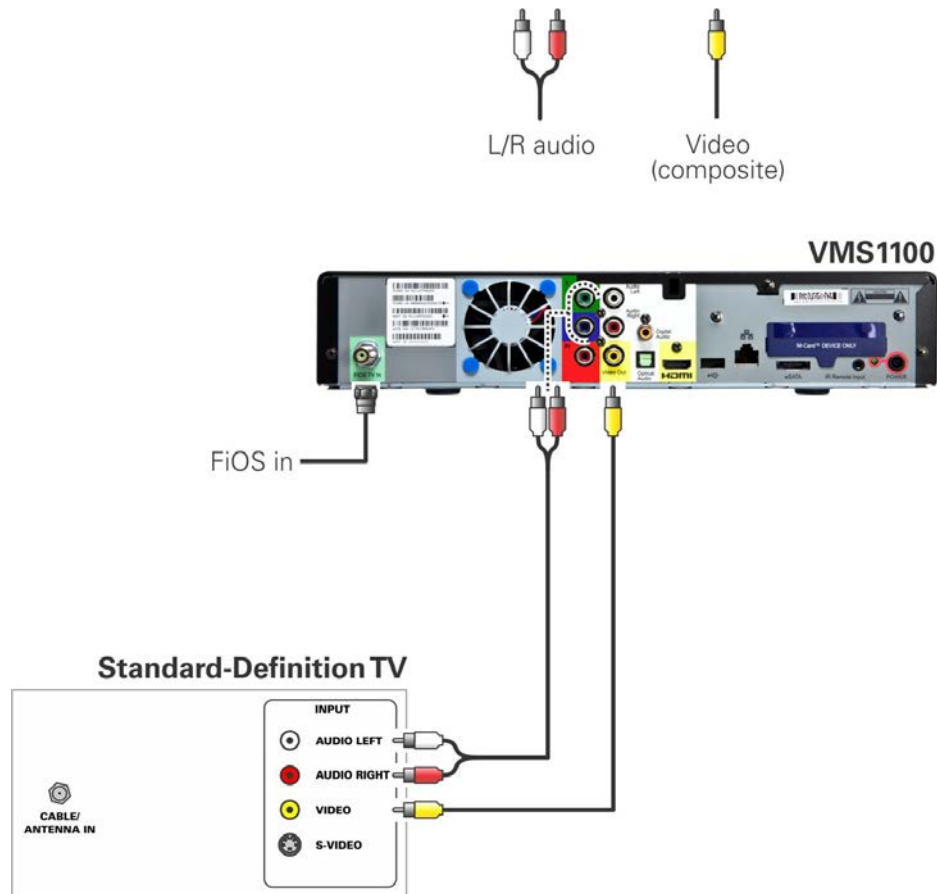

Figure 15 – Standard-Definition TV Connection

Connecting a Standard-Definition TV, AV Receiver, and VCR

Note: Because some entertainment equipment cannot simultaneously support composite video and S-Video, never simultaneously connect both video inputs.

Note: This connection method does not support HDTV. For more information, see [Connecting a High-Definition TV \(HDTV\) for Video](#).

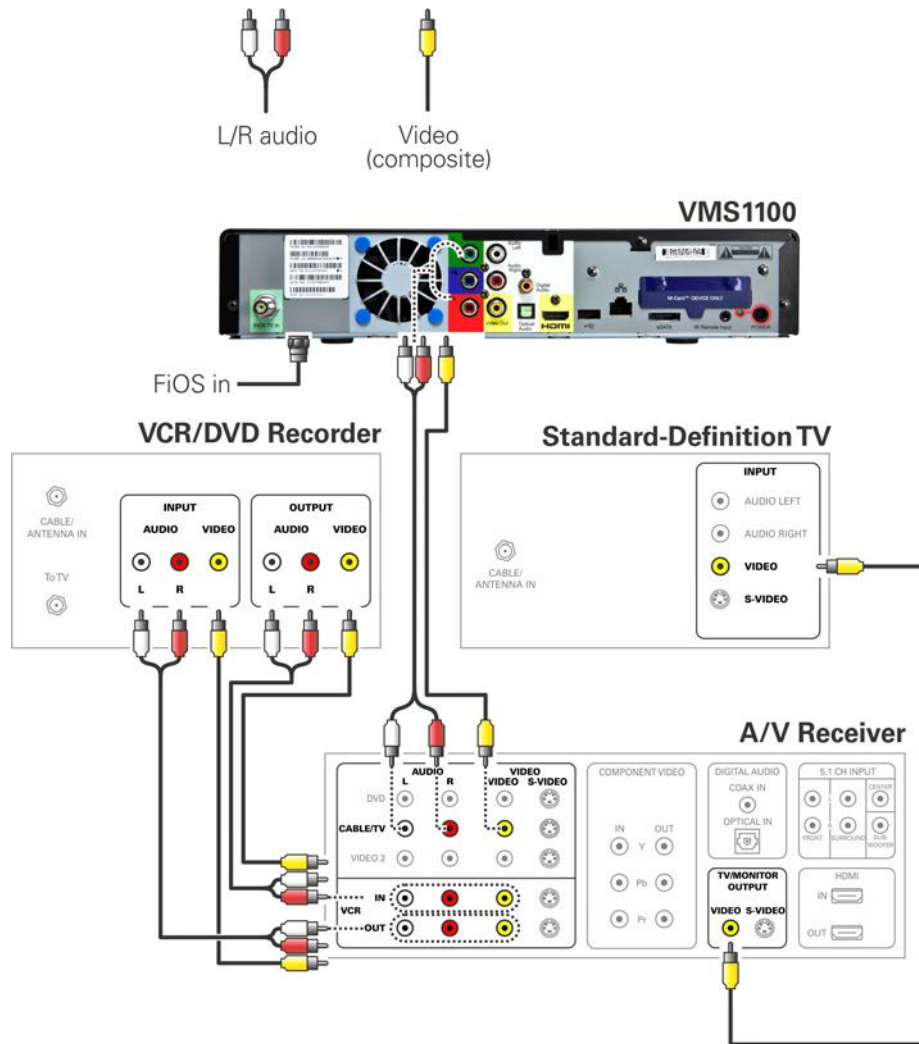

Figure 16 – Standard-Definition TV, AV Receiver, and VCR Connection

Auto-Provisioning

The auto-provisioning process will streamline the set-top installation and provide informative diagnostics that will assist you in resolving issues as they are detected. After the VMS1100 and IP Client set-tops are connected to the home network and the VMS1100 is powered ON, an automatic pre-health check is performed to identify any potential connection problems. The VMS1100 will conduct a series of self-tests to verify proper network connectivity and signal levels.

During the activation process, the system health and status are monitored and displayed on the VMS1100 Onscreen menu. Instructions are provided to help resolve any problems discovered during the activation process. If you encounter any additional problems during the automated health check, see [Troubleshooting](#) for more information.

Note: The VMS1100 must be provisioned first in order to properly prepare the IPC1100 for activation.

After the registration process, the software download process will begin. A progress indicator on the VMS1100 will show the appropriate steps for the following processes:

- Server Connection
- Software Server Identification
- Software Download

Starting the Auto-Provisioning Process

1. Plug the power cord on the VMS1100 into an electrical wall outlet. Do NOT power ON the IPC1100 set-top(s) until after the network and TV connections are completed.
2. Press **OK** on the VMS1100 remote control when the Verizon Welcome screen displays (see Figure 17).
Note: If **PrOk**, **PrOK**, or **PrOH** appears on the VMS1100 front panel LED display, press the **OK** button on the VMS1100 top panel or hand-held remote.
3. The Verizon Welcome-Start Activation screen displays (see Figure 18) and the VMS1100 automatically starts performing a series of self-tests.
4. Press **A** on the VMS1100 remote control to navigate to the first detailed auto-provisioning screen (see Figure 20).

Note: If a problem is detected during the connectivity check, follow the onscreen instructions to correct the issue (see Figure 23 for sample error screenshot).

1. Upon completion of the software download, the device will send a message to the management server which will start the network activation process (see Figure 25).
2. After the health check and any necessary corrective steps, the VMS1100 will register with the Verizon provisioning server and production management servers (see Figure 26).
3. If any problems are encountered with these steps, follow the onscreen instructions to rectify the problem.
4. The management server will set the VMS1100 to active and instruct it to reboot. After rebooting, the Verizon FiOS TV will start up (see Figure 28). The VMS1100 is now ready for service.

Sample VMS1100 Self-Test Screens

Note: The screens provided in this section are intended for illustrative purposes only. They are a sampling of the screens you may see during the auto-provisioning process. In some cases, the actual data may differ from the examples provided.

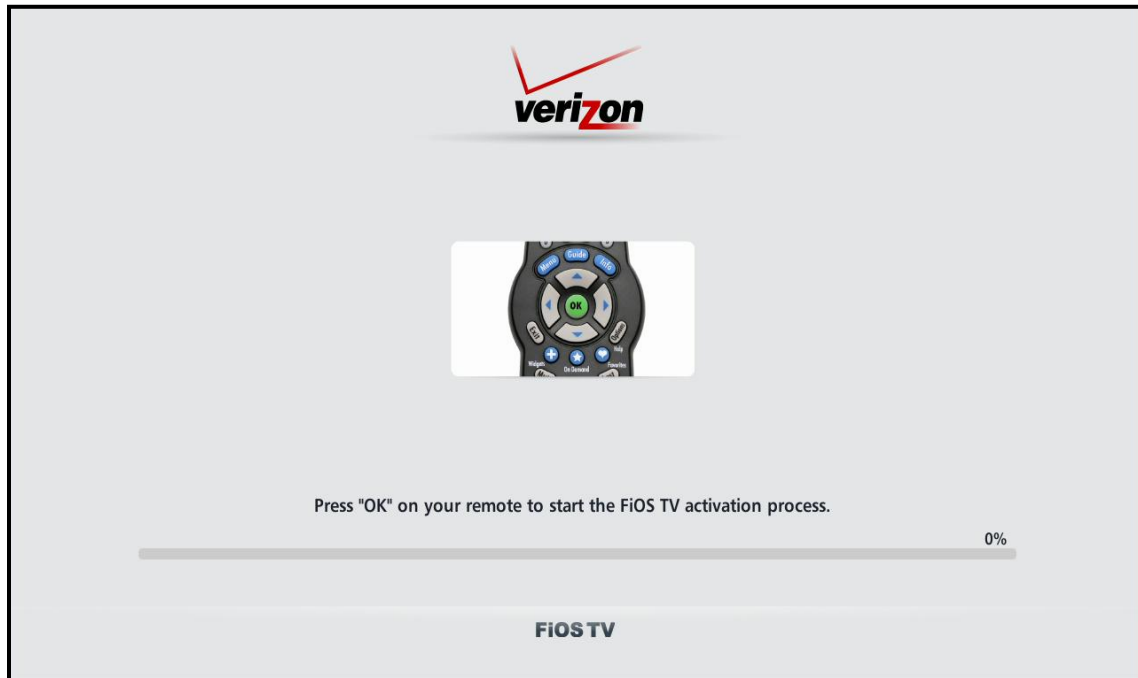

Figure 17 – Welcome Screen

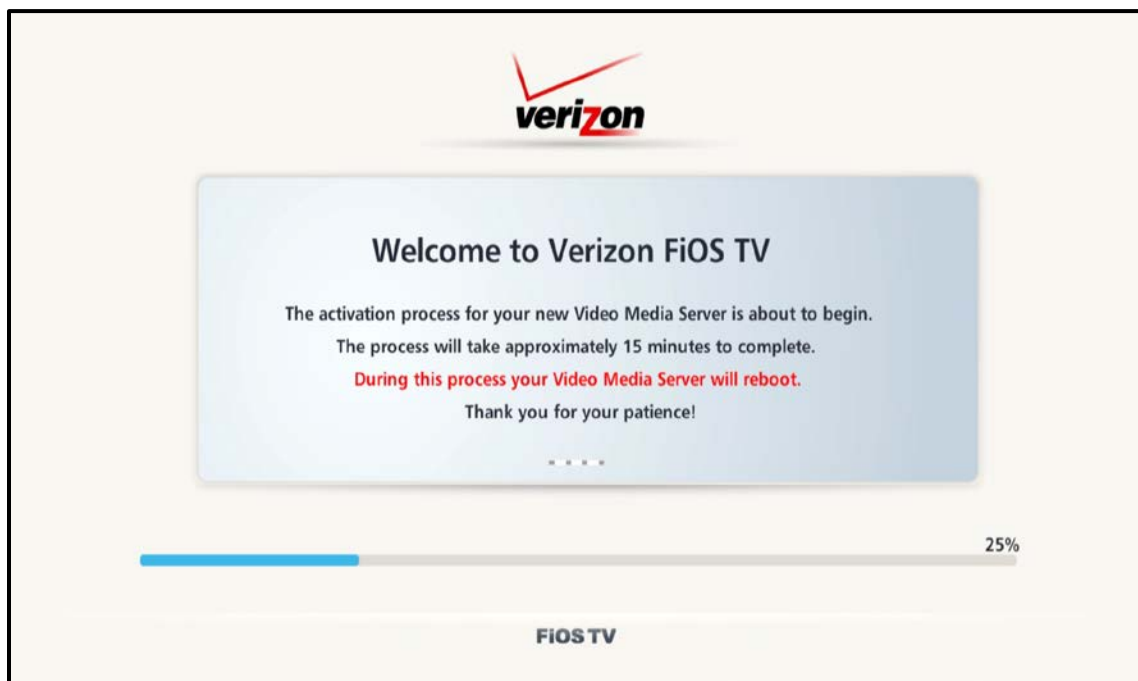

Figure 18 – Welcome-Start Activation Screen

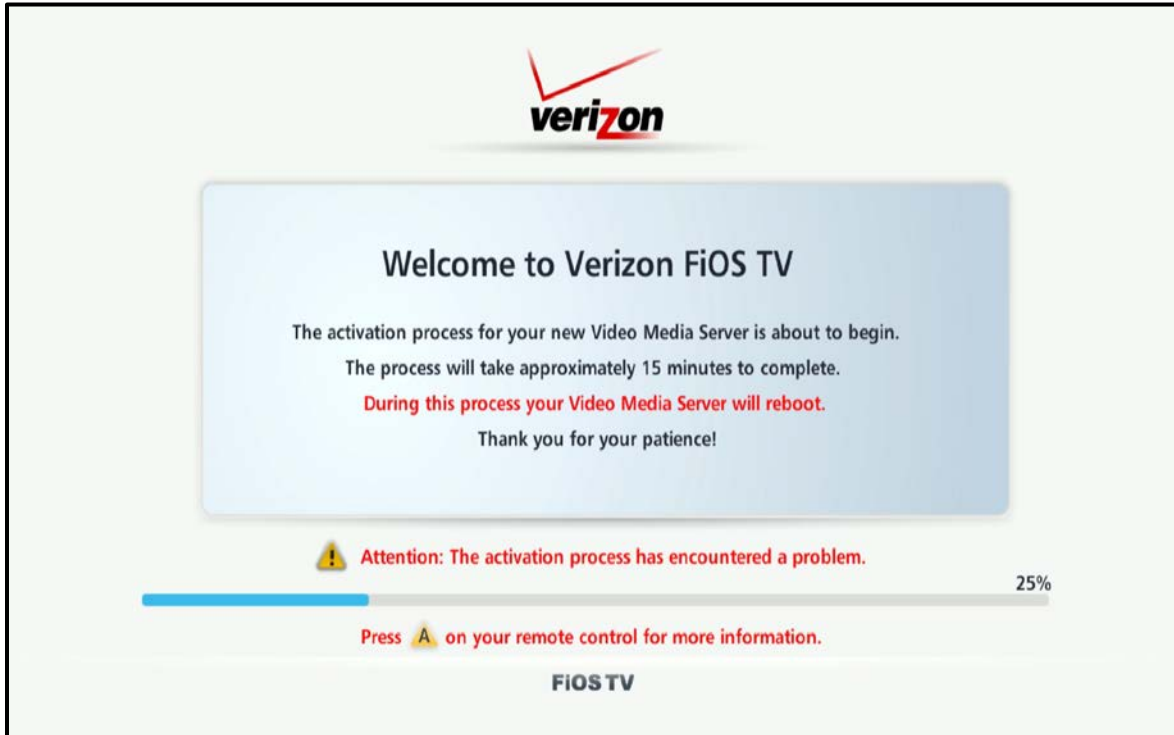

Figure 19 – Sample Welcome-Start Activation Error Screen



Figure 20 – Step 1:-Coax Connection Test Screen (1 of 5)

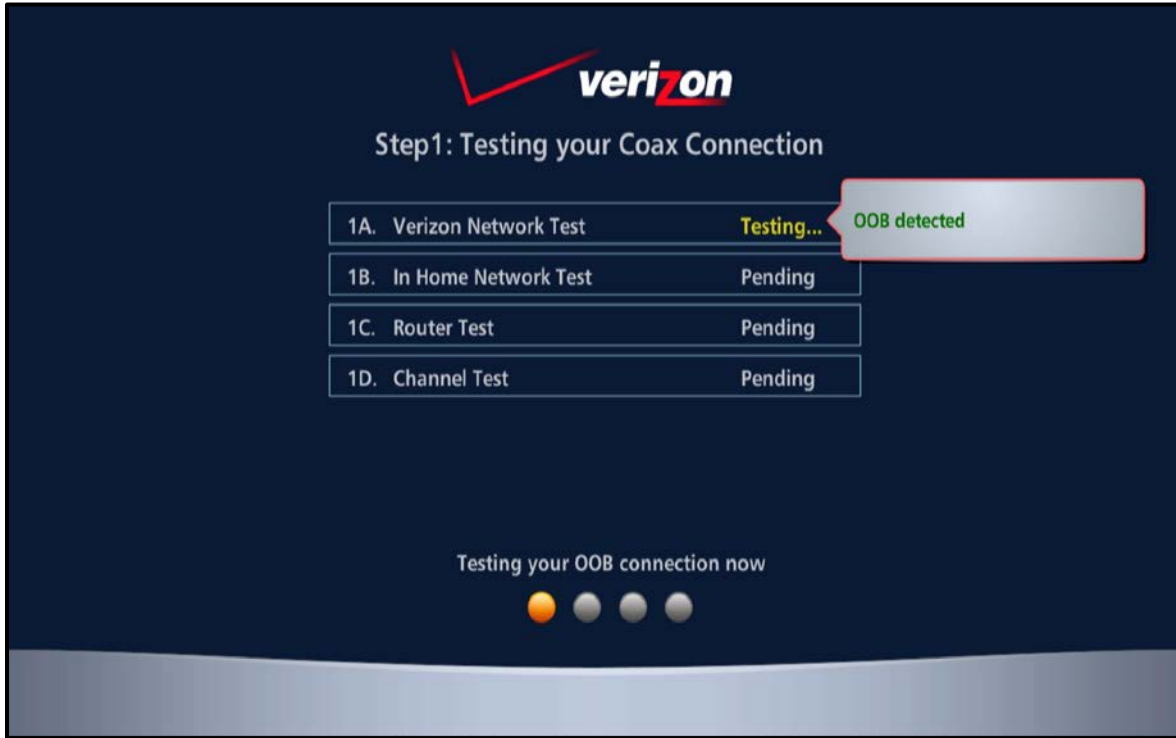

Figure 21 – Step 1:-Coax Connection Test Screen (2 of 5)



Figure 22 – Step 1: Sample Coax Connection Warning Screen (3 of 5)

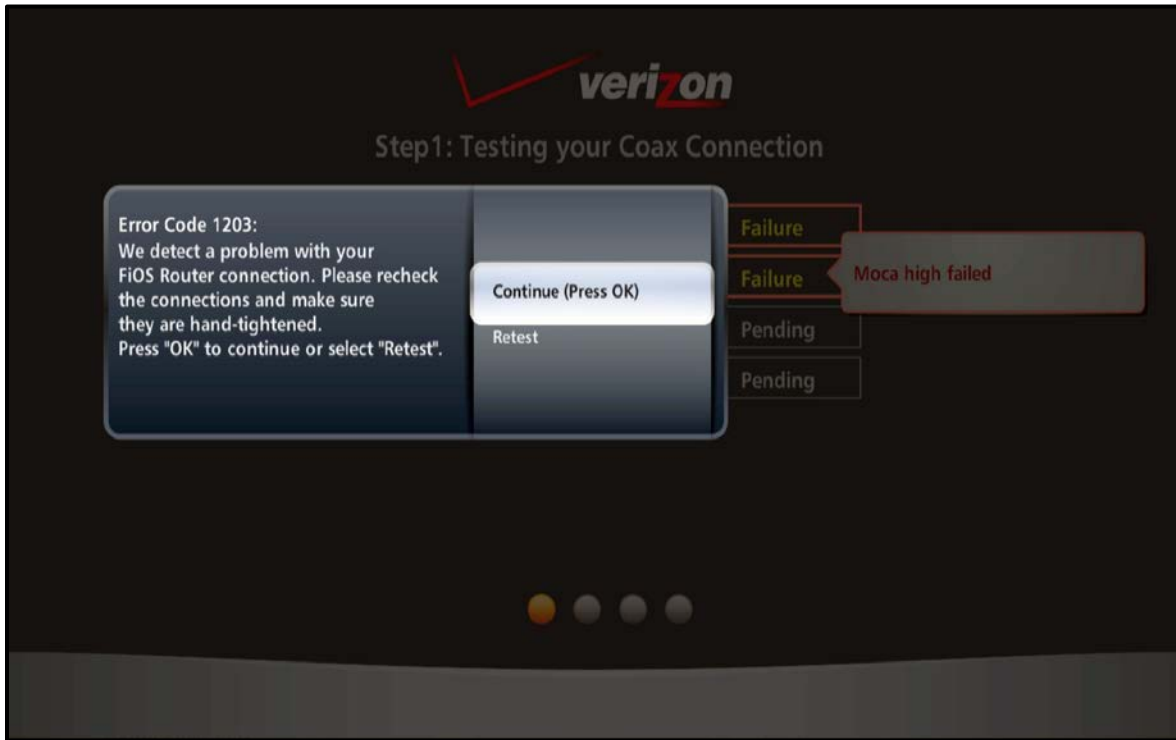

Figure 23 – Step 1: Step 1: Sample Coax Connection Error Screen (4 of 5)

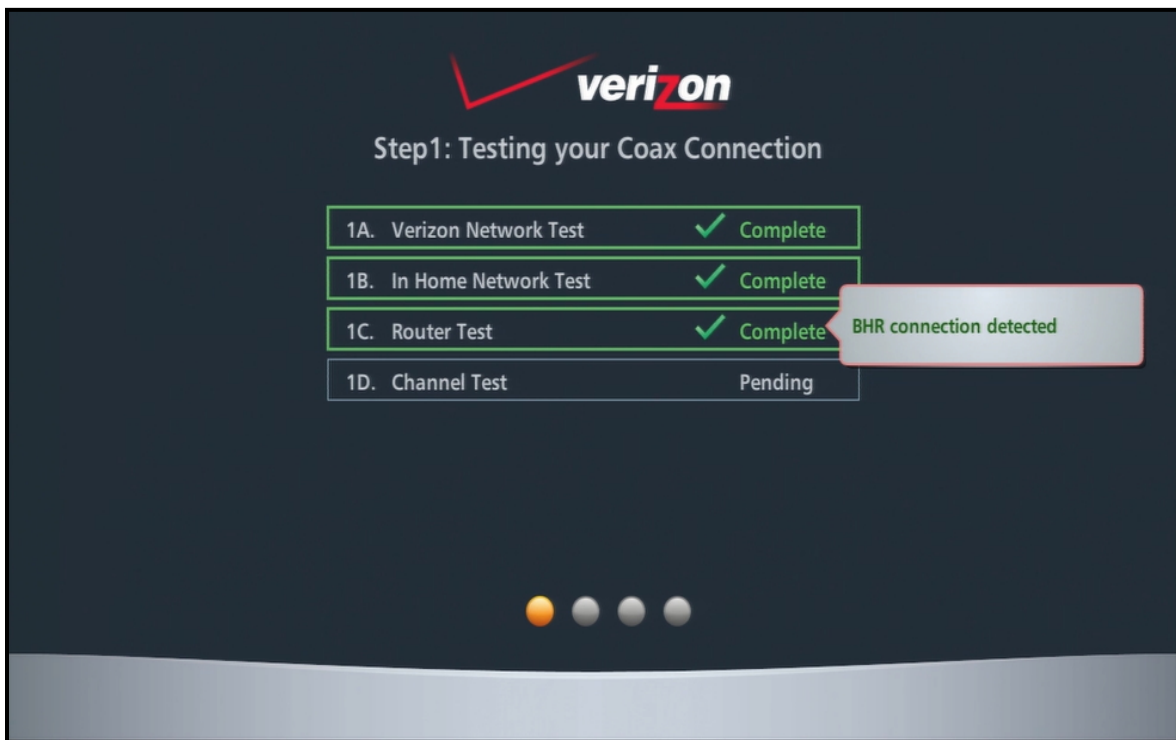

Figure 24 – Step 1: Coax Connection Test Screen n (5 of 5)

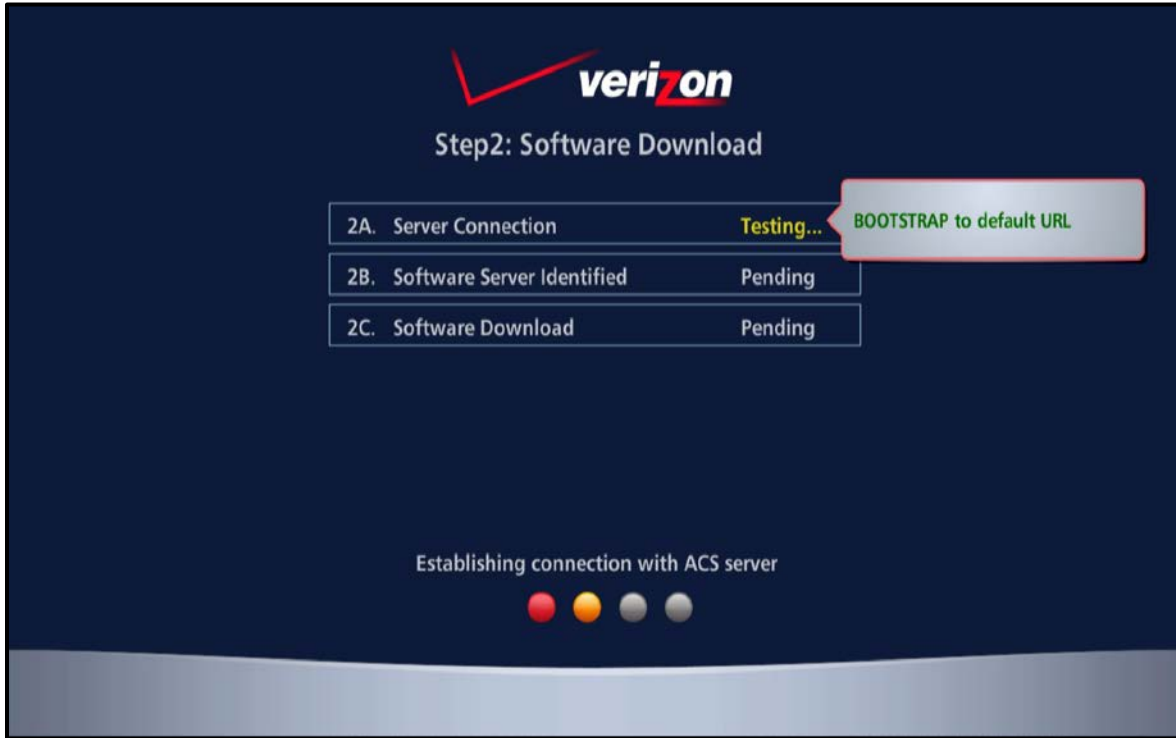

Figure 25 – Step 2: Software Download Test Screen (1 of 3)

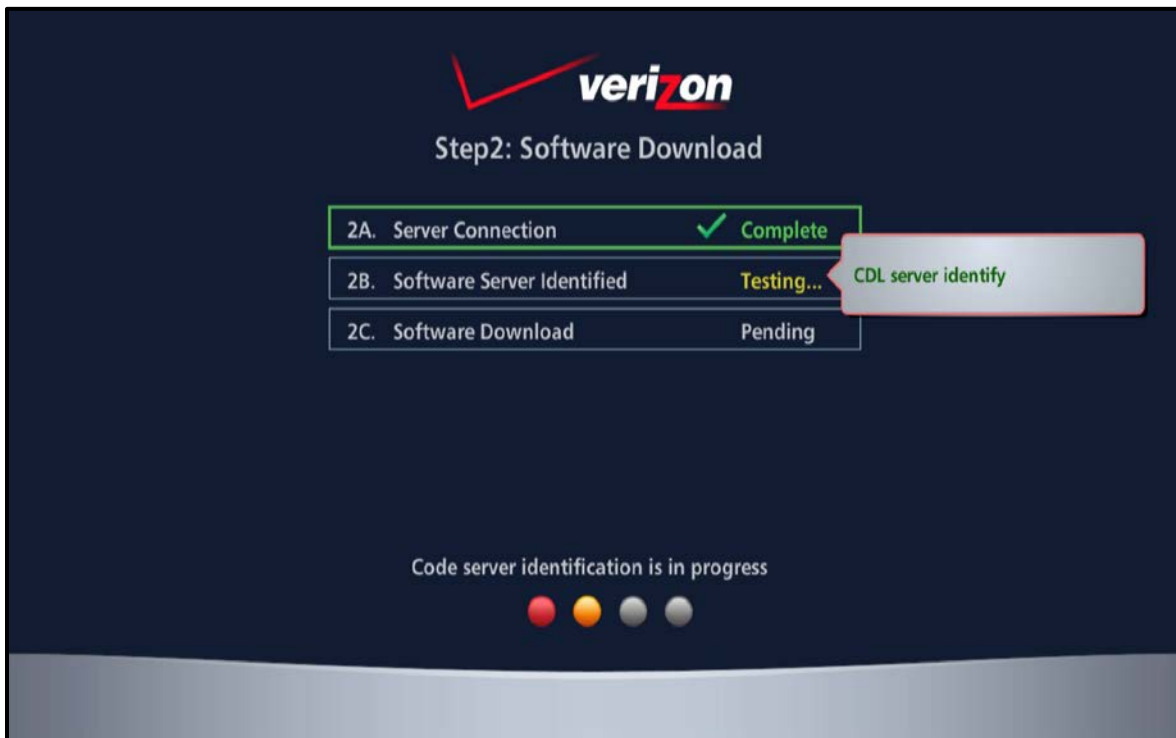

Figure 26 – Step 2: Software Download Test Screen (2 of 3)

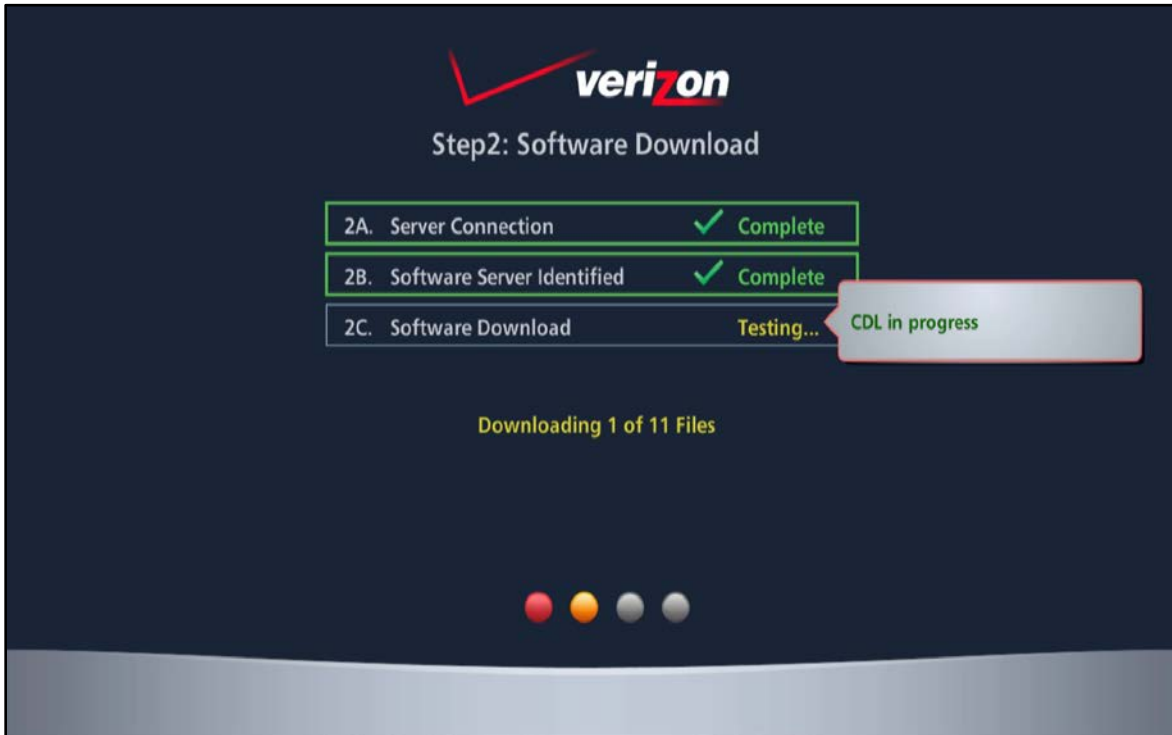

Figure 27 – Step 2: Software Download Test Screen (3 of 3)

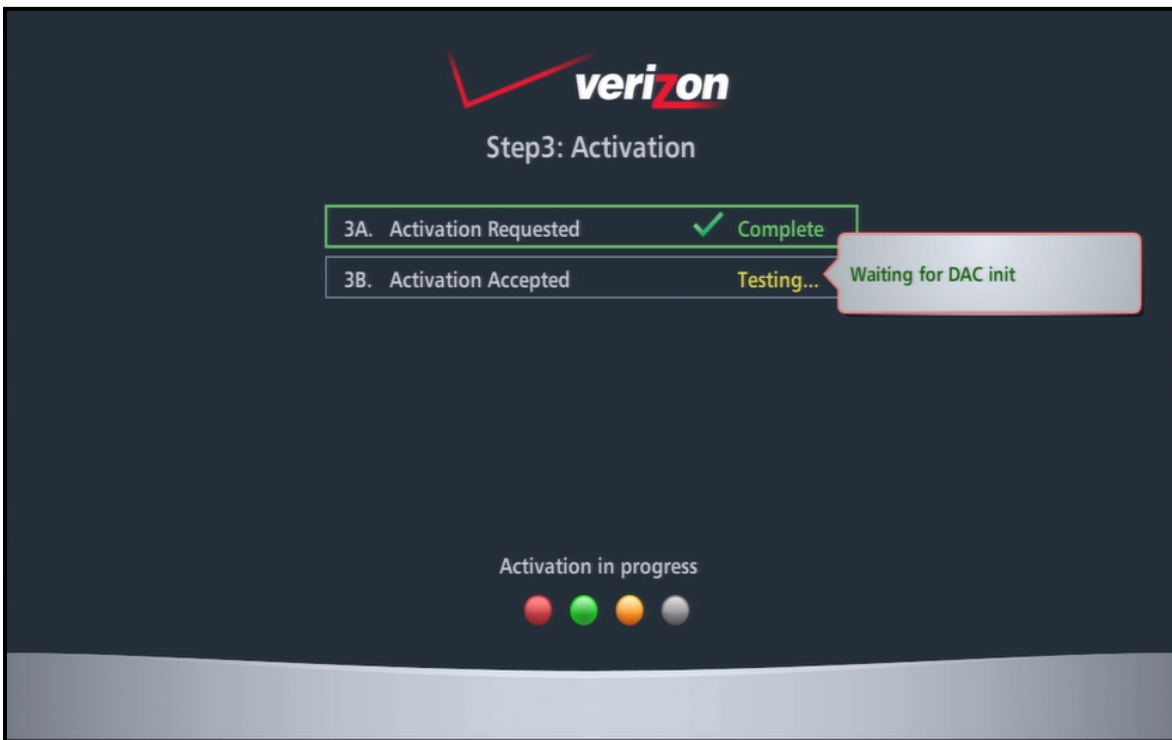
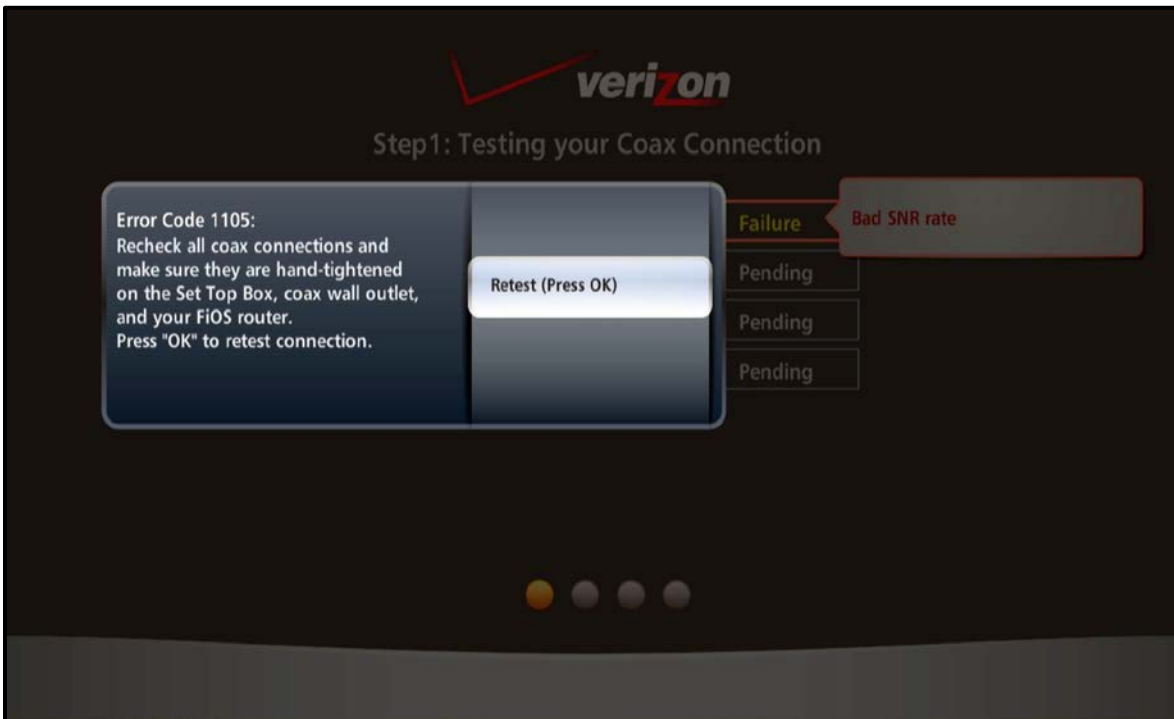

Figure 28 – Step 3: Activation Screen



Figure 29 – Activation Complete Screen

Sample VMS1100 Self-Test Error and Warning Screens



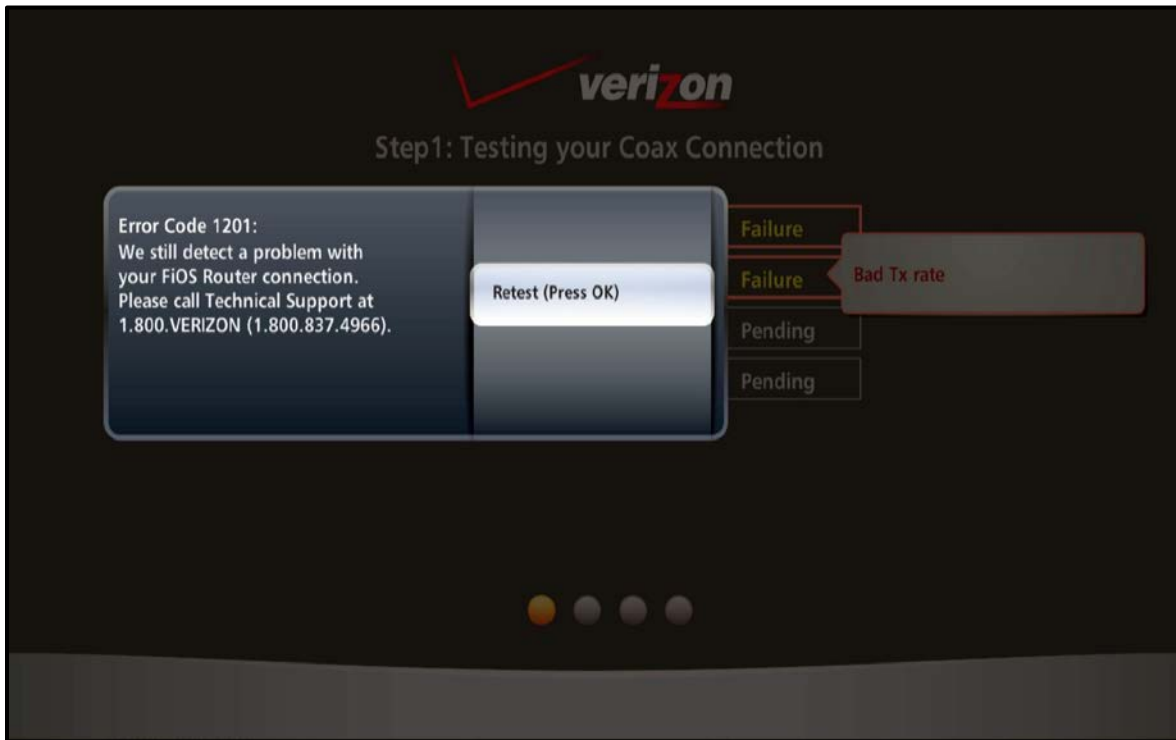
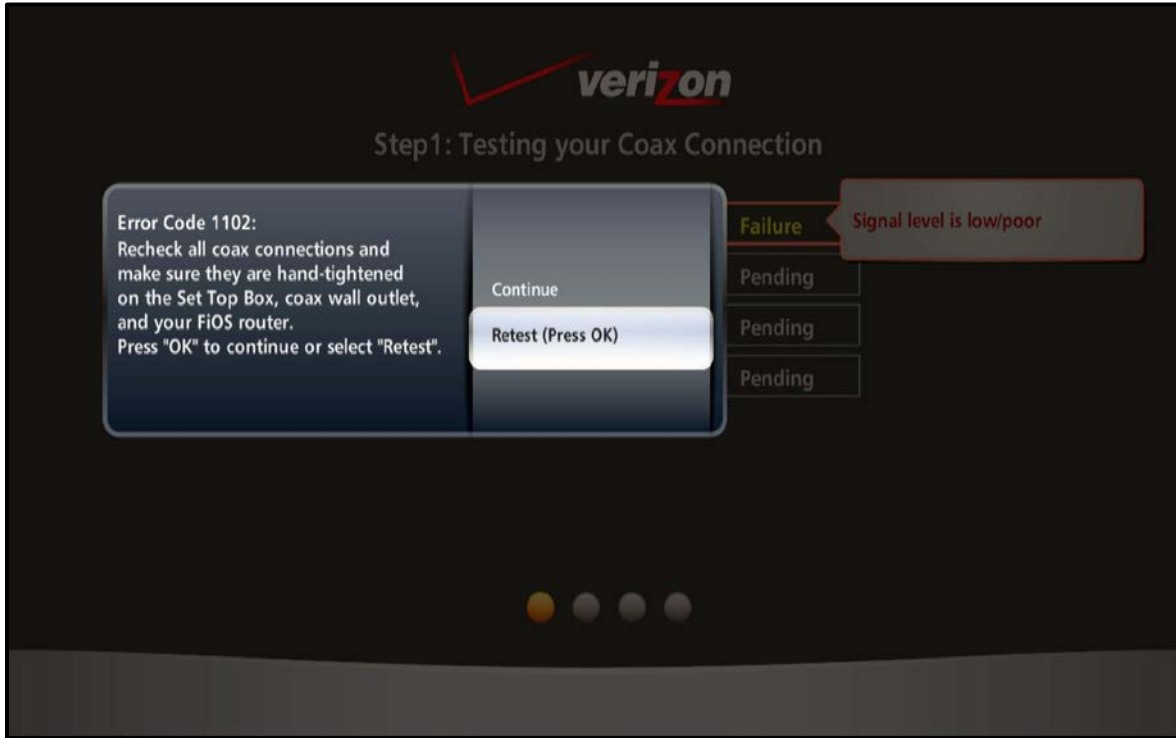

Operational Check for the Remote Control

The operational check tests communication with the remote control.

Table 9 – Remote Control Test

FEATURE	TESTING PROCEDURE
Power ON	Press Power on the remote control to turn ON the VMS1100. Tune to the output channel (3 or 4), if using the RF output.
Channel Selection	Scan through the channels using the Channel + or - keys. Tune to several channels by entering the channel number using the numeric keys.
Volume Control	Press Volume + or - on the remote control to increase the volume to its upper limit, lowest level, and to a comfortable level. Press mute to turn the sound off. Press mute again to restore the sound.

If the VMS1100 does not operate properly, see [Troubleshooting](#) for more information.

Accessing the Basic User Interface (BUI)

The BUI contains onscreen display (OSD) diagnostics, front panel diagnostics, and user settings. The BUI allows you to retrieve diagnostics without having to power OFF the application.

Note: *It is recommended that you use the BUI menu to access the OSD diagnostics. Do the following to open the OSD diagnostics:*

1. **Method 1** - Press and hold the **D** key on the IR remote control for five seconds and then release the key to display the BUI Main Menu (see Figure 30).
 - a. Select Diagnostics to navigate to the onscreen diagnostics.
 - b. Select User Settings to navigate to the high-definition video User Settings menu.
2. **Method 2** – Power ON the VMS1100 and then immediately press the **Select** key (or **OK** key) on the IR remote control twice.



Figure 30 – Basic User Interface (BUI) Main Menu

Note: The MotoPLYR diagnostics are not available once the VMS1100 is booted up. Please refer to the MotoPLYR Client Installation and Operation Manual for more information.

Optimizing the High-Definition Settings

This section describes how to optimize the SD and HD video settings and closed captioning based on subscriber preferences.

Do the following before changing the output settings:

1. Connect the VMS1100 to the other home entertainment devices.
2. Plug the power cord on the VMS110 into an electrical wall outlet.
3. Check that the VMS1100 has successfully completed the auto-provisioning process and has connectivity to the IPC1100 set-top(s) through the home network.
4. Turn ON the TV.

Note: For an HDMI connection, check that the TV is ON and that **HDMI** is selected as the input before adjusting the settings. ARRIS recommends using certified Standard (or "category 1") HDMI cables for 1080i or 720p resolutions. A certified high-speed (or "category 2") HDMI cable is recommended for resolutions of 1080p.

There are two methods for accessing the User Setting menu to optimize the output settings:

- Use the BUI menu. See [Accessing the Basic User Interface \(BUI\)](#) for more information.
- Manually configure the user settings (see below).

To optimize the user settings:

1. Power OFF the VMS1100 and immediately press the **Select** key and then press the **Menu** key on the remote control.

If the TV is ON, the onscreen menu will display the user settings that you can configure (see Figure 31).

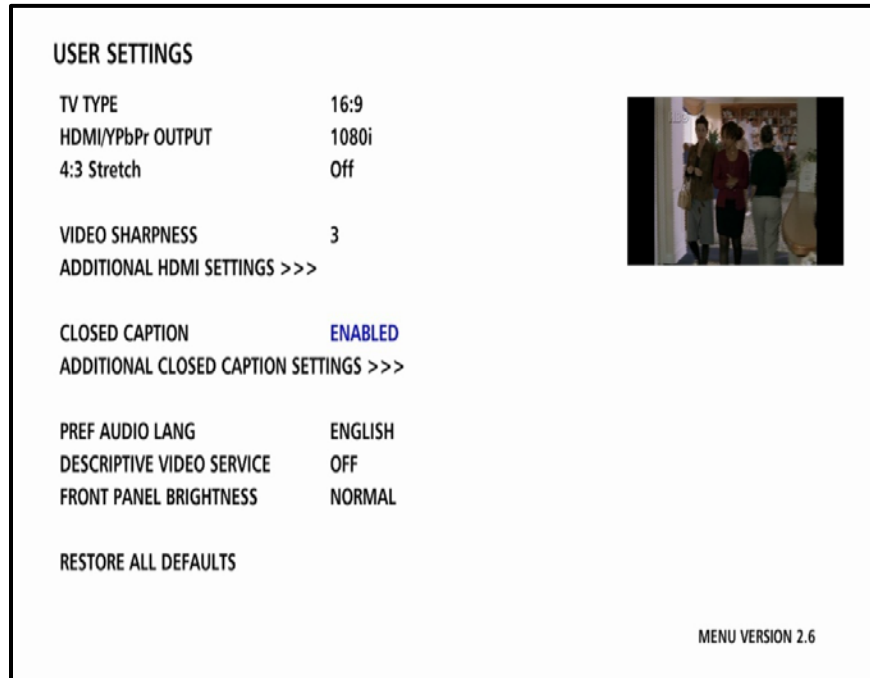

Figure 31 – User Settings Screen

2. Use the remote control or the cursor keys on the front panel to navigate the onscreen menus:
 - o Press the ▲ and ▼ keys to highlight the setting you wish to change.
 - o Press the ► key to select an option.
 - o To exit the setting and move to another setting, press the ▲ or ▼ key.
 - o To exit the menu and save your settings, press the **Power** or **Menu** key.
3. If the User Setting screen does not display on the HDTV screen, the TV may not support the default video output setting. Use the front panel display to adjust the settings as described in [There is no video on the TV screen](#) in the Troubleshooting section.

Table 10 – User Settings Fields

SETTINGS	DESCRIPTION
TV Type	<p>Allows you to specify the style of television connected to the set-top. Options include 16:9, 4:3 LETTERBOX, and 4:3 PAN SCAN. By default, the 16:9 option is selected. The options are used as follows:</p> <ul style="list-style-type: none"> • 16:9 designates that a widescreen television is connected to the set-top. • 4:3 LETTERBOX designates that a standard screen television is connected to the VMS set-top and that widescreen programs should be scaled to fit the screen with black bars above and below the picture. • 4:3 PAN SCAN designates that a standard screen television is connected to the VMS set-top and that widescreen programs should be cropped so that the picture fills the entire screen.

SETTINGS	DESCRIPTION
HDMI/YPbPr OUTPUT	<p>Allows you to specify the video output format of the VMS set-top for all content (when the 4:3 override setting is OFF) or for all 480p, 720p, and 1080i content (when the 4:3 override is ON).</p> <p>Options include:</p> <ul style="list-style-type: none"> • 1080p60 — The VMS set-top will present programs in the High-Definition 1080p60 format (1920 x 1080 pixels). • 1080i — Default option: The VMS set-top will present programs in the High-Definition 1080i format (1920 x 1080 pixels). • 720p — The VMS set-top will present programs in the High-Definition 720p format (1280 x 720 pixels). • 480p — The VMS set-top will present programs in the Enhanced-Definition 480p format (720 x 480 pixels). • 480i — The VMS set-top will present programs in the Standard-Definition 480i format (720 x 480 pixels). <p>Some televisions may only support certain video formats. Please consult your television's user manual for more information on format compatibility.</p> <p>The VMS set-top can detect when the HDMI connection is in use. If you are not using the HDMI connection on the VMS set-top, the HDMI/YPbPr Output setting will display as YPbPr Output in the User Settings Menu.</p>
4:3 Stretch	<p>On — The VMS set-top will automatically stretch all standard-definition programs to a widescreen aspect ratio and present the video in the format designated by the HDMI/YPbPr Output setting. Note that the Stretch option is only available when the TV Type setting is 16:9.</p> <p>Off — Default option: The VMS set-top will create a widescreen version of a standard-definition program by adding black bars to the left and the right of the picture and present the video in the format designated by the HDMI/YPbPr Output setting.</p>
Video Sharpness	<p>Controls the sharpness adjustment for the video.</p> <p>Ranges from 1 (softest) to 5 (sharpest). Default is 3.</p>
Closed Caption	<p>Enables or disables closed captions. The front panel display indicates the status of the closed captions.</p> <p>Available options: Enabled or Disabled (default)</p>
Pref Audio Lang	<p>Allows selection of a preferred audio language.</p>
Descriptive Video Service	<p>Enabled Descriptive Video Service (DVS), if available in the content.</p>
Front Panel Brightness	<p>Controls the brightness adjustment for the front panel clock display.</p>
Restore All Defaults	<p>Resets all the User Setting configurable parameters to their default values.</p>

Additional HDMI Settings

The Additional HDMI Settings menu is used to configure advanced options that affect the operation of the VMS1100 with HDMI and DVI display devices. Adjustable options include:

- Display mode
- Color Space
- Audio Output mode
- Lip Sync
- Lip Sync Delay
- 1080p24 Pass-Through

The Additional HDMI Settings menu screen is illustrated and defined below:

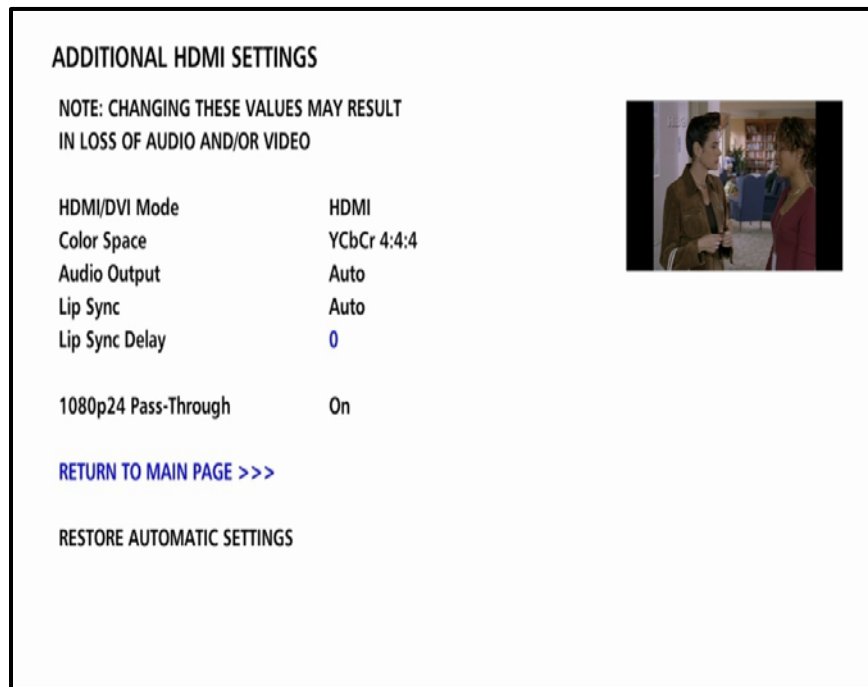

Figure 32 – Additional HDMI Settings Screen

Table 11 – Additional HDMI Settings Fields

FIELD	DESCRIPTION
Additional HDMI Settings	<p>The Additional HDMI Settings option is available whenever an HDMI connection is in place.</p> <p>Selecting this option will present a new menu screen with settings specific to the HDMI connection, for example DVI/HDMI mode, Color Space, Audio Output, and Lip Sync settings.</p>
HDMI/DVI Mode	<p>The HDMI/DVI Mode setting allows you to optimize the HDMI output to work with both DVI-equipped televisions and HDMI-equipped televisions.</p> <p>By default, this option is set to HDMI. The options are used as follows:</p> <p>HDMI — The VMS1100 is optimized to work with an HDMI television or home theater receiver.</p> <p>DVI — The VMS1100 is optimized to work with a DVI television or display device (connected via an HDMI-to-DVI adapter).</p>
Color Space	<p>The Color Space setting allows you to adjust the color space used by the VMS1100 to generate the video signals on the HDMI output. By default, this option is set to YCC 4:4:4. The options are used as follows:</p> <p>YCC 4:4:4 — The VMS1100 will generate video signals within the YCC color space.</p> <p>RGB — The VMS1100 will generate video signals within the RGB color space.</p> <p><i>Note: Adjusting these settings could result in a loss of video. Only a professional installer or someone with a good working knowledge of the color spaces supported by the TV should change this setting.</i></p>
Audio Output	<p>The Audio Output setting allows you to specify the digital audio format delivered over the HDMI output by the VMS1100.</p> <p>The options are used as follows:</p> <p>Auto (default) —The VMS1100 will provide the digital audio format specified by the connected device (TV or home theater receiver) when that device was first connected to the VMS1100.</p> <p>L-PCM — The VMS1100 will provide all audio in the Linear Pulse Code Modulation digital audio format. The L-PCM format is widely supported by most HDMI televisions and home theater receivers.</p> <p>Pass-Through — The VMS1100 will provide the same digital audio format on the HDMI output as is provided with the program being viewed at that time. For example, if the program has a Dolby Digital soundtrack, the VMS1100 will pass the Dolby Digital audio to the HDMI output. This option is most useful when connecting the VMS1100 to a home theater receiver that has HDMI switching capability.</p> <p><i>Note: Adjusting these settings could result in a loss of audio. Only a professional installer or someone with a good working knowledge of the digital audio formats supported by the TV and/or home theater receiver should change this setting.</i></p>

FIELD	DESCRIPTION
Lip Sync	<p>The Lip Sync setting allows you to adjust the amount of time the audio signal is delayed with respect to the video signal on the HDMI output. Some HDMI televisions and home theater receivers add an extra delay to the video signal during processing which can produce an effect where the audio noticeably “leads” the video.</p> <p>By default, this option is set to Auto. The options are used as follows:</p> <p>Auto — The VMS1100 will automatically delay the audio signal on the HDMI output by the amount of time requested by the connected HDMI device.</p> <p>Manual — The VMS1100 will delay the audio signal on the HDMI output by the amount of time selected for the Lip Sync Delay setting.</p> <p>Off — The VMS1100 will not delay the audio signal on the HDMI output.</p>
Lip Sync Delay	<p>The Lip Sync Delay setting is only available when the Lip Sync option has been set to Manual. The Lip Sync Delay setting can be adjusted between 0 milliseconds (msec) and 500 milliseconds in 50 millisecond increments.</p> <p>If the Lip Sync option has been set to either Auto or Off, this option will be disabled and no longer selectable in the menu.</p> <p>Use this option to adjust the HDMI audio delay if you notice that the video image routinely seems to be “behind” the audio soundtrack when using your HDMI device.</p>
1080p24 Pass-Through	Enables the pass through of 1080p24 content directly to the TV.
Return To Main Page	Use this option to return to the User Settings Menu main screen.
Restore Automatic Settings	<p>Use this option to restore all of the settings on this screen (HDMI/DVI Mode, Color Space, Audio Output, and Lip Sync) to their default value.</p> <p>You can also use this option if audio and/or video has been lost after adjusting these settings from their default values.</p>

Additional Closed Caption Settings

The Additional Closed Caption Settings menu is used to adjust the various display options for closed caption legibility. Customizable options include font size, font style, font color, and font opacity. You may also select to view different closed caption services if these are included within the broadcast program.

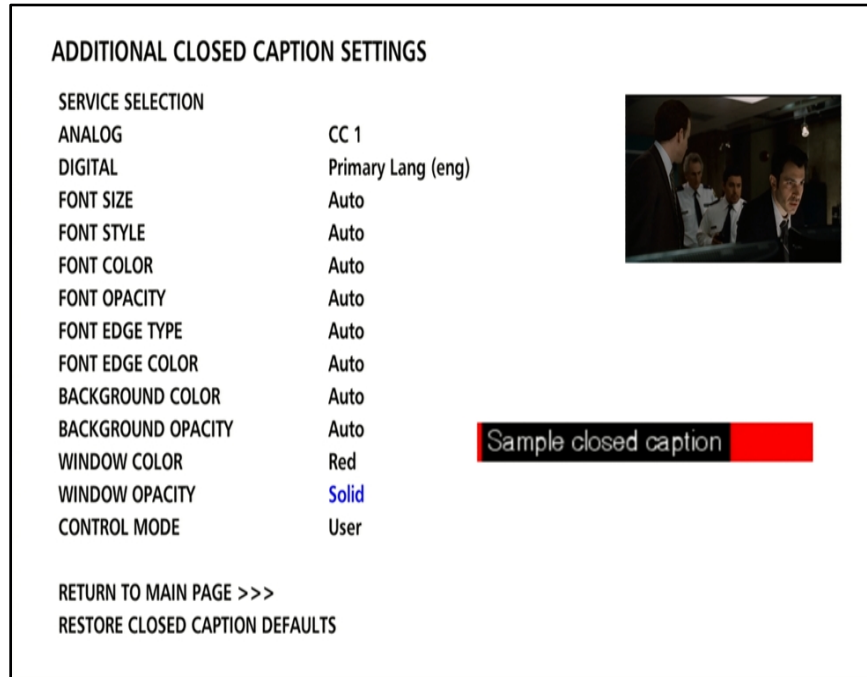

Table 12 – Additional Closed Caption Settings Fields

FIELD	DESCRIPTION
Service Selection	Sets the service used by the VMS1100 to render (draw) the closed captions:
Analog	This setting affects closed captions for analog and digital standard definition services. Available options are: CC1 (default), CC2 , CC3 , CC4 , T1 , T2 , T3 , or T4
Digital	This setting affects closed captions for digital enhanced definition and high definition services. Available options: <ul style="list-style-type: none"> • Primary Language (default) • Secondary Language • 3, 4, 5, or 6

FIELD	DESCRIPTION
Font Size	<p>Sets the font size for closed captions.</p> <p>Available options:</p> <ul style="list-style-type: none"> Auto (default) Standard Large Small
Font Style	<p>Sets the font style for closed captions.</p> <p>Available options:</p> <ul style="list-style-type: none"> Auto (default) Mono Serif Proportion Serif Mono No Serif Proportion No Serif Casual Cursive Small
Font Color	<p>Sets the font color. Available options:</p> <ul style="list-style-type: none"> Primary Language (default) Secondary Language 3, 4, 5, or 6Auto White Black Red Green Blue Yellow Magenta Cyan
Font Opacity	<p>Sets the opacity. Available options:</p> <ul style="list-style-type: none"> Auto (Default) Transparent Translucent Solid Flashing

FIELD	DESCRIPTION
Font Edge Type	Sets the edge appearance. Available options: Auto None Raised Depressed Uniform Left Shadowed Right Shadowed
Font Edge Color	Sets the edge color. Available options: Auto (Default) White Black Red Green Blue Yellow Magenta Cyan
Background Color	Sets the background color for closed captions. Available options: Auto (Default) White Black Red Green Blue Yellow Magenta Cyan
Background Opacity	Sets the background opacity for closed captions. Available options: Auto (default) Transparent Translucent Solid Flashing
Window Color	
Window Opacity	

FIELD	DESCRIPTION
Control Mode	Sets the closed caption settings. Available options: Auto (default) User
Return to Main Page	Selecting this option will return you to the User Setting screen.
Restore Closed Caption Defaults	To reset all of the Additional Closed Caption settings to their default values: Select this option and press the ► key.

Graphics Overlaying the Video

The VMS1100 can generate graphics that overlay the video programming or fill the entire television screen. Common examples include onscreen menus (such as the User Setting menu), closed captions, and IPG. The VMS1100 overlays these graphics whenever you open a menu, enable closed captions, or scroll through a program grid.

Onscreen graphics are available for all VMS1100 video outputs.

4

Diagnostics

Diagnostics are displayed on the onscreen display (OSD) and VMS1100 front panel display. You can access, control, and navigate through the diagnostic screens using the VMS1100 front panel controls or remote control. The diagnostics confirm proper installation, including the following:

- Checking error states and signal integrity
- Identifying the cable terminal on the network
- Verifying communications with the headend

The following information applies to the diagnostics outlined in this section:

- All indicators are in decimal notation, unless noted otherwise.
- All signal level and quality indicators use a 1% to 100% scale, unless noted otherwise.
- All sample displays are illustrative; actual data may differ from the examples provided in this manual.

Note: All sample displays used in this manual are for illustrative purposes only. The actual data may differ from the examples provided.

Accessing the Diagnostics

Do the following to start using the diagnostics:

1. Make sure the VMS1100 is powered ON.
2. Choose either method below to access the User Settings screen:
 - o BUI menu

Press and hold the **D** key on the IR remote control for five seconds and then release the key to display the BUI Main Menu. Select **01 Diagnostics** on the BUI main menu.

- o Manually configure the user settings

Press **Power** and then immediately press **Select** on the remote control twice to open the Diagnostics main menu. This method will power OFF the application and is not recommended if diagnostic information is needed for video or session status.

The Diagnostics main menu will display on the OSD and **d01** will appear in the VMS1100 display panel window.

d0 Diagnostics Main Menu

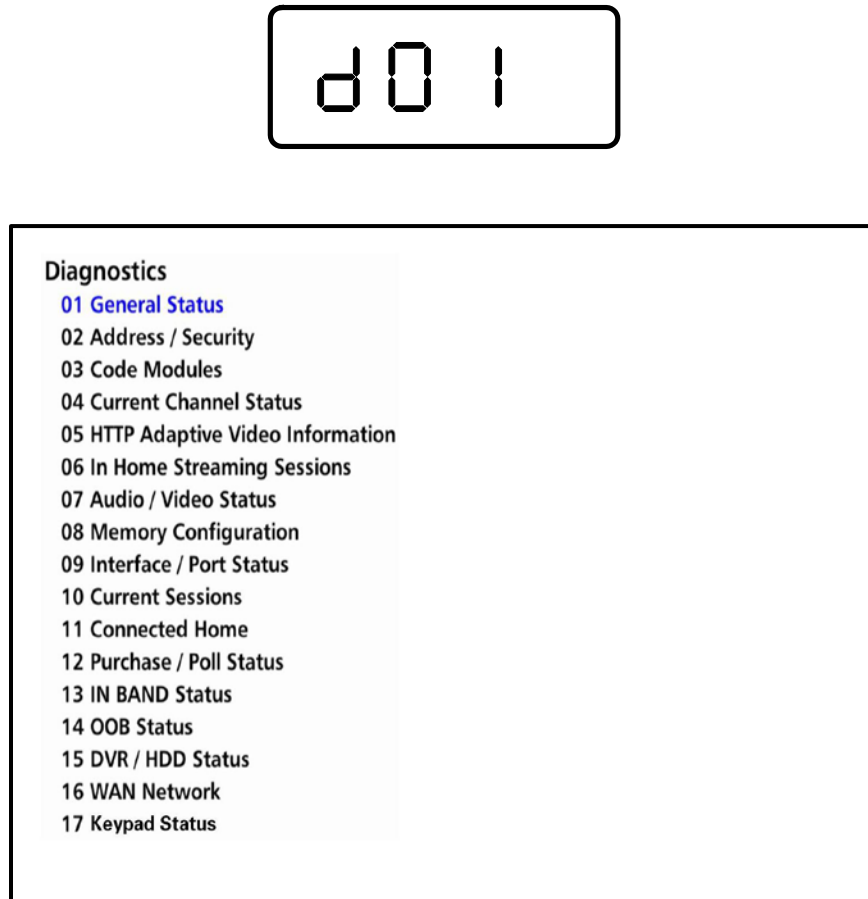

Figure 33 – Diagnostics Main Menu

Use the following keys on the remote control or VMS1100 front panel to navigate the Diagnostics menus:

1. Press channel ▲, channel ▼, cursor ▲, or cursor ▼ to select d01 through E.
2. Press **cursor** ◀, **cursor** ▶, select or enter to execute the selected diagnostic.
3. Select **E** from the main menu or press **Power** to exit.

d01 General Status

This diagnostic displays system status information on the OSD and front panel. The information is updated each time the diagnostic is displayed.

General Status	
Error:	E00
Platform ID:	0x0340
Chip Set:	Bcm7425B2
Family ID:	0x002d
Model ID:	0x9002
Settop Local Time:	Wed Apr 10 2013 12:05:45 GMT-0400
DST Active:	Yes
STD Time Offset:	GMT-0500
DST Entry Time:	Sun Apr 07 2013 03:00:00 GMT-0400
DST Exit Time:	Sun Oct 27 2013 02:00:00 GMT-0500
Total Run Time:	0H 4M
Version Number:	KA1.2-Maint.298785
Encryption Algorithm:	CONFORMING_CSA
Connected:	True
Channel Map Present:	True
VMS Activation Status:	False

Page 1 of 2 vvv Scroll Down vvv

General Status		^^^ Scroll Up ^^^
Power State:	On	
Provisioning Status:	N/A	
Provisioning Errors:	-1	
Provisioning Error and Description:	NOT SET	
Provisioning Error Corrective Action:	NOT SET	
SSL Device ID:	0x001AD15E20,000000193D8674,00001CEFB152	
DTCP Device ID:	FFDFA41A1F	
Config File Version:	N/A	
Boot Inform Window:	90	

Page 2 of 2

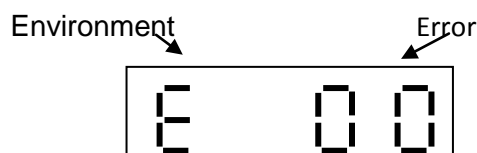

Table 13 – General Status Fields (Page 1 of 2)

FIELD	DESCRIPTION																										
Error	Error codes display on the front panel and OSD. If multiple errors occur, the last recorded error is displayed.																										
	<table border="1"> <thead> <tr> <th>ERROR CODE</th> <th>DESCRIPTION</th> </tr> </thead> <tbody> <tr> <td>EP00</td> <td>No error</td> </tr> <tr> <td>EP01</td> <td>Not connected</td> </tr> <tr> <td>EP03</td> <td>DRAM error</td> </tr> <tr> <td>EP04</td> <td>SRAM error</td> </tr> <tr> <td>EP07</td> <td>ROM verification failure</td> </tr> <tr> <td>EP08</td> <td>RAM test failure</td> </tr> <tr> <td>EP09</td> <td>Battery test failure</td> </tr> <tr> <td>EP11</td> <td>Invalid unit address</td> </tr> <tr> <td>EP12</td> <td>Power on self test failure</td> </tr> <tr> <td>EP14</td> <td>GITV startup failure</td> </tr> <tr> <td>EP15</td> <td>TSI structure corrupt</td> </tr> <tr> <td>EP18</td> <td>Driver initialization failure</td> </tr> </tbody> </table>	ERROR CODE	DESCRIPTION	EP00	No error	EP01	Not connected	EP03	DRAM error	EP04	SRAM error	EP07	ROM verification failure	EP08	RAM test failure	EP09	Battery test failure	EP11	Invalid unit address	EP12	Power on self test failure	EP14	GITV startup failure	EP15	TSI structure corrupt	EP18	Driver initialization failure
ERROR CODE	DESCRIPTION																										
EP00	No error																										
EP01	Not connected																										
EP03	DRAM error																										
EP04	SRAM error																										
EP07	ROM verification failure																										
EP08	RAM test failure																										
EP09	Battery test failure																										
EP11	Invalid unit address																										
EP12	Power on self test failure																										
EP14	GITV startup failure																										
EP15	TSI structure corrupt																										
EP18	Driver initialization failure																										
Platform ID	A unique, 16-bit hexadecimal number that identifies the platform image (also called the ROM ID).																										
Chip Set	Identifies the Chip set used by the hardware																										
Family ID	The manufacturer and product family, in hexadecimal.																										
Model ID	The model, in hexadecimal.																										
Settop Local Time	The local time configured by the system																										
DST Active	Indicates Daylight Savings Time																										
STD Time Offset	The time zone, based on standard time offset from GMT																										
DST Entry Time	Indicates entry of Daylight Savings Time and if DST is currently active																										
DST Exit Time	Indicates exit of Daylight Savings Time and if DST is currently active																										

Total Run Time	The number of hours and minutes since product last rebooted
Version Number	Software version of the platform code
Encryption Algorithm	Indicates secure processor decrypt scheme, for example: CSA — Connect Scrambler algorithm DES — Data Encryption Standard
Connected	An operations connect or disconnect message determines whether the product is True or False .
Channel Map Present	Indicates if the product is configured with a Channel Map.
VMS Activation Status	Indicates the Activation Status as provisioned by the headed as True or False (may be VMS or Client Activation Status, depending on product)

Table 14 – General Status Fields (Page 2 of 2)

FIELD	DESCRIPTION
Power State	Indicates logical power state of product, for example, On or Standby
Provisioning Status	Indicates the Status of auto-provisioning in descriptive text
Provisioning Errors	Indicates any error codes provided by the auto-provisioning process
Provisioning Error and Description	Indicates any auto-provisioning error in descriptive text
Provisioning Error Corrective Action	Indicates the corrective action associated with any auto-provisioning error in descriptive text
SSL Device ID	Indicates the Device ID used in SSL
DTCP Device ID	Indicates the DTCP Device ID
Config File Version	Indicates the version number of the configuration file used to provision the product.
Boot Inform Window	Indicates the time window configured for the TR-069 inform delay.

d02 Unit Address / Security

This diagnostic displays the unit address of the M-Card (cable card), if inserted in the M-Card™ DEVICE ONLY slot.

Unit Address	
CableCard Inserted:	Yes
Unit Address:	000-00637-07573-160
Host Serial No	
Host Serial No.:	M11220TDM266
4 MAC Addresses Installed	
MAC - Address 2:	00 21 1e d6 17 03
MAC - Address 4:	00 21 1e d6 17 05
MAC - Address 5:	00 21 1e d6 17 04
MAC - Address 6:	00 21 1e d6 17 06
Page 1 of 2	vvv Scroll Down vvv

Separable Security		^^^ Scroll Up ^^^
Card Interface:	GOOD	
CableCard ID:	000-063-707-573-0	
Host ID:	044-980-705-028-0	
Data ID:	370-328-774-92	
Validation:	Valid	
Pairing Method:	Not Available	
Provider Phone #:	Not Available	
Cable Card		
Object Name:	MCblCard	
Object Ver:	06.28	
Manufacturer:	0x0000	
HW Version:	05540500030f	
Boot Version:	04.01	
2nd Version:	Not Available	
Serial Number:	MT1220TNAD61	
MAC Address:	20 e5 64 38 7b b2	
Page 2 of 2		

The front panel displays the unit address of the device when the Address/Security screen is displayed, if the device supports a unit address. See the following examples:

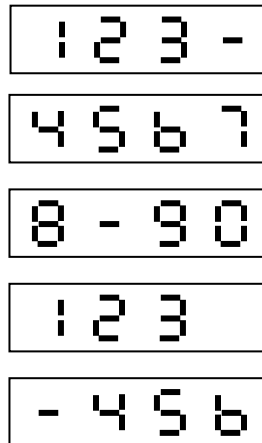

Table 15 – Unit Address Fields (Page 1 of 2)

FIELD	DESCRIPTION
CableCARD Inserted	YES — CableCARD is inserted NO — CableCARD is not inserted
Unit Address	A unique decimal number that indicates the unit address of the CableCARD.
Host Serial Number	Displayed on the Unit Address Diagnostic screen.
4 MAC Addresses Installed	The MAC addresses are stored in protected flash and displayed in hexadecimal.

Table 16 – Separable Security Fields (Page 2 of 2)

FIELD	DESCRIPTION
CARD Interface	CableCARD Interface is a status indication of the interface between the VMS and CableCARD. It will indicate 'Good' if no errors were detected, 'Error' if there is a problem detected with establishing the CableCARD interface, or 'Unsupported CARD' if the inserted CableCARD is not an M-CARD.
CableCARD ID	The unique identifier provided by the CableCARD.
Host ID	The unique identifier in the VMS Device Certificate.
Data ID	A value generated by the CableCARD for the Pairing report.

FIELD	DESCRIPTION
Validation	<ul style="list-style-type: none"> • UNKNOWN if a Validation message was not received by the product • VALID or INVALID as set by the Host Validation Message received from the headend • BINDING if the CableCARD is busy with the binding authentication process • NOT BOUND if Card validation status is not bound for CableCARD reasons • HOST CERTIFICATE INVALID if the status is not bound because the Host Certificate was invalid • HOST SIGN FAILED if status is not bound because of failure to verify Host's SIGN • AUTH KEY FAILED if status is not bound because of failure to match AuthKey from the Host Device • FAILED if binding failed for other reasons
Pairing Method	Set to 'MMI' or 'Reportback' as received by a message from the headend, or set to 'Unknown' if the headend message was not received.
Provider Phone #	Phone Number of the Provider as configured at the headend.
Cable Card	
Object Name	Code object name executing on the CableCARD.
Object Ver.	Code object version executing on the CableCARD.
Manufacturer	CableCARD manufacturer.
HW Version	Version number provided by the CableCARD.
Boot Version	Version number provided by the CableCARD.
2nd Version	Version number provided by the CableCARD.
Serial Number	The CableCARD Serial Number provided by the CableCARD.
MAC Address	The CableCARD MAC Address provided by the CableCARD.

d03 Code Modules

This diagnostic includes information about the firmware loaded in flash memory and all non-volatile code versions are installed on the VMS series. It is possible to access the diagnostics of the application operating system and all associated objects when the native suite is running.

Host Download Information	
Group ID:	87
Region ID:	N/A
Primary Server Download Path:	Unicast
Secondary Server Download Path:	Undefined
Code Installation May Start Time:	Thu Apr 04 2013 21:12:00 GMT-0500
Code Installation Must Start Time:	Fri Apr 05 2013 05:12:00 GMT-0500
Code Installation Start Time:	Tue Apr 09 2013 09:28:40 GMT-0400
Code Installation End Time:	Tue Apr 09 2013 09:32:49 GMT-0400
Code Installation Status:	Completed
Number of Software Objects:	11
Campaign Download Status:	MRL downloading
Campaign Version:	1.0.0

Page 1 of 14 vww Scroll Down vww

MRL Information		^^^ Scroll Up ^^^
MRL XML File Name:	MasterXml.xml	
MRL Multicast IP Address:	232.192.0.1	
MRL Multicast Destination Port:	49152	
MRL Source IP Address:	204.120.170.205	
MRL PID:	1980	
MRL Url:		
MRL IPMC Join Interval:	10	
Next MRL IPMC Join Time:	Wed Jul 24 2013 15:47:34 GMT-0400	
Last Successful MRL IPMC Join Time:	Wed Jul 24 2013 15:38:15 GMT-0400	
MRL Error:	DL26	
Select Multicast, Unicast, or NoTrigger and Press OK		
MRL Download Trigger >>>	Multicast	

Page 2 of 14 vww Scroll Down vww

Card Download		^^^ Scroll Up ^^^
MCard Download Channel:	Not Available	
MCard DL PID:	Not Available	
MCard DL Segment Count:	Not Available	
MCard DL Status:	Reserved	
MCard DL Error:	Not Available	
MCard Object Name:	Not Available	
MCard Object Version:	Not Available	

Page 3 of 14 vww Scroll Down vww

host Object Table 1	
Object Name:	KA1.2_Maint
Object Version:	0.0.0.0
Object Size:	35774448 Bytes
Download Status:	Executing
Associated DL Errors:	DL00
Download Server IP Address:	https://gil1.mot-mobility.com/95335ed8-8a45-48bb-8a66-79f68
Current DL Server Type:	Unicast
Number of Bytes Downloaded:	35774448
Download Start Time:	Tue Apr 09 2013 09:27:55 GMT-0400
Download Complete Time:	Tue Apr 09 2013 09:27:59 GMT-0400
CDL % Complete:	100
Multicast IP:	N/A
Multicast IP Destination Port:	N/A
Object PID:	N/A

Page 4 of 14 vww Scroll Down vww

If a download is in progress, the completion percentage for the current download will display on the VMS1100 front display panel.

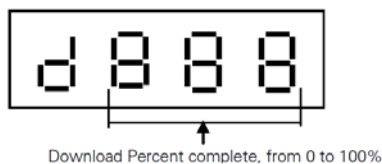

Table 17 – Code Modules – Host Download Information Fields (Page 1)

FIELD	DESCRIPTION
Group ID	Identifies the product configured Group.
Region ID	Identifies the product configured Region.
Primary Server Download Path	Available primary method for Code download options: <ul style="list-style-type: none"> •Multicast •Unicast •N/A
Secondary Server Download Path	Available secondary method for Code download options: <ul style="list-style-type: none"> •Multicast •Unicast •Undefined •N/A
Code Installation May Start Time	Configured time from the MRL when the product may start to download.
Code Installation Must Start Time	Time from the MRL when the product must start to download.
Code Installation Start Time	Date and time (local time) when the code installation was started.
Code Installation End Time	Date and time (local time) when the code installation was complete.
Code Installation Status	Available code installation status options: <ul style="list-style-type: none"> Pending In progress Completed Failed <p>Failure status indicates two attempts for installation of the successfully downloaded campaign have failed.</p>
Number of Software Objects	Number of software objects loaded on the set-top including the objects being currently downloaded.
Campaign Download Status	Available download status options of the campaign: <ul style="list-style-type: none"> • MRL Downloading • (Code Name) Downloading • Download Complete • No New Campaign
Campaign Version	Version of the software object loaded / downloading onto the set-top, expressed as major-minor 'x.y.z' version number.

Table 18 – Code Modules – MRL Information Fields (Page 2)

FIELD	DESCRIPTION
MRL XML File Name	MRL file name, if available
MRL Multicast IP Address	Multicast address required for MRL file download. This parameter is optional if the MRL gets downloaded via IP unicast method.
MRL Multicast Destination Port	Destination port parameter for the MRL file download. This parameter is optional if the MRL gets downloaded via the IP unicast method
MRL Source IP Address	Source IP address of the server. For multicast, this server is responsible for Multicasting the MRL file. For unicast, the STB downloads the MRL file from this server.
MRL PID	PID of the MRL file in the DSMCC carousel, if available.
MRL Url	
MRL IPMC Join Interval	Interval, in minutes, for the product to join the MRL Multicast address for downloading the MRL file, if available.
Next MRL IPMC Join Time	Scheduled data and time when the product is expected joined the MRL multicast, if available.
Last Successful MRL IPMC Join Time	Time when the product last successfully joined the MRL multicast, if available.
MRL Error	Indicates the error (DLxx format), if any, that occurred during the download: <ul style="list-style-type: none"> • DL00 - No-error • DL21 - Invalid MRL source • DL22 - Unable to join MRL multicast • DL23 - Failed to authenticate MRL file • DL24 - Invalid MRL file • DL25 - Unable to parse MRL • DL26 - MRL without matching target type • DL27 - MRL missing campaign for target type

Table 19 – Code Modules – Card Download Fields (Page 3)

FIELD	DESCRIPTION
MCard Download Channel	Download channel configured for the MCard Object
MCard DL PID	Download PID detected for the M-Card Object
MCard DL Segment Count	Download segment count, if M-Card object is in the process of downloading.
MCard DL Status	Download status from M-Card: <ul style="list-style-type: none"> • 0x00 Idle • 0x01 WaitDLPID • 0x02 WaitSeg0 • 0x03 Loading • 0x04 AuthStor • 0x05 WaitEnabl • 0x06 WaitReset
MCard DL Error	<ul style="list-style-type: none"> • 0x00 None • 0x01 Segment 0 timeout • 0x02 Header CRC error • 0x03 Image CRC error • 0x04 Image authentication error • 0x05 Flashing error • 0x06 Object enable timeout • 0x07 Done and waiting for reset • 0x08 Wrong image version • 0x09 Host busy • 0x0A Host did not find download PID
MCard Object Name	M-Card object name of the object being downloaded.
MCard Object Version	M-Card object version of the object being downloaded.

Note: Additional Host Object Table pages will display as the number of software objects increases.

Table 20 – Code Modules – Host Object Table Fields (Page 4)

FIELD	DESCRIPTION
Object Name	Name of the software object loaded or downloading onto the set-top.
Object Version	Version of the software object loaded / downloading onto the set-top.

FIELD	DESCRIPTION
Object Size	Indicates the object size.
Download Status	Status of the object download, expressed as a text string, which may include: <ul style="list-style-type: none"> • Available • Download-in-progress • Download-Completed • Download-Paused • Authenticating • Activation-Pending • Installing • Executing • Executing-but-Deletion-Pending • Error • Other
Associated DL Errors	Indicates the error, if any, that occurred during the download: <ul style="list-style-type: none"> • DL00 - No-error • DL01 - Object incompatible with the target STB • DL02 - The object cannot be found • DL03 - Reserved • DL04 - Reserved • DL05 - Reserved • DL06 - The object fails validation / authentication • DL07 - Storage capacity exceeded • DL08 - Reserved • DL11 - Download timed out • DL12 - Unable to join the multicast group • DL13 - Low memory • DL14 - Invalid object format • DL15 - Unsupported object type
Associated DL Errors (continued)	<ul style="list-style-type: none"> • DL16 - Unable to reach unicast URL • DL17 - Unable to resolve unicast URL • DL18 - File does not exist" • DL19- Cannot access file • DL31 - Could not flash
Download Server IP Address	IP address of the server from which the object is downloaded. In case of Multicast, it represents the Source IP.
Current DL Server Type	Type of download server currently being used:

FIELD	DESCRIPTION
	<ul style="list-style-type: none"> • Multicast • Unicast • N/A
Number of Bytes Downloaded	Indicator of the download progress provides the current value of the number of bytes received
Download Start Time	Date and time (local time) when the object download started.
Download Complete Time	Date and time (local time) when the object download completed
CDL % Complete	Indicator of download progress provides the current percent complete of the object download.
Multicast IP	The Multicast address required for the object download. Meaningful, only if the object is downloaded via IP multicast.
Multicast Destination Port	Multicast Destination port for the object download. Meaningful, only if the object is downloaded via IP multicast
Object PID	PID for the object in the DSMCC carousel; the number of objects will increase the number of pages displayed, as necessary.

d04 Current Channel Status

This diagnostic displays current channels and services entering the home, including screens for Current Channel Status. Six screens will display for the six IB tuners and a seventh screen will display for the IP stream.

The following screens illustrate information for IB tuner 1, IB Tuner 2, and IP Stream:

Current Channel Status	
IB Tuner1	
ECM Data Present:	False
Virtual Channel Number:	2
Service Encrypt Mode:	CLR
Preview:	NO
Purchasable:	NO
Purchased:	NO
EPOCH Num:	Not Available
Auth Reason:	Not Available
VCT ID:	2
CCI:	00
APS:	00
CIT:	0

Page 1 of 7 vvv Scroll Down vvv

Current Channel Status		^^^ Scroll Up ^^^
IB Tuner2		
ECM Data Present:	N/A	
Virtual Channel Number:	N/A	
Service Encrypt Mode:	Not Available	
Preview:	Not Available	
Purchasable:	Not Available	
Purchased:	Not Available	
EPOCH Num:	Not Available	
Auth Reason:	Not Available	
VCT ID:	1	
CCI:	Not Available	
APS:	Not Available	
RC Flag:	Not Available	
CIT:	Not Available	

Page 2 of 7 vvv Scroll Down vvv

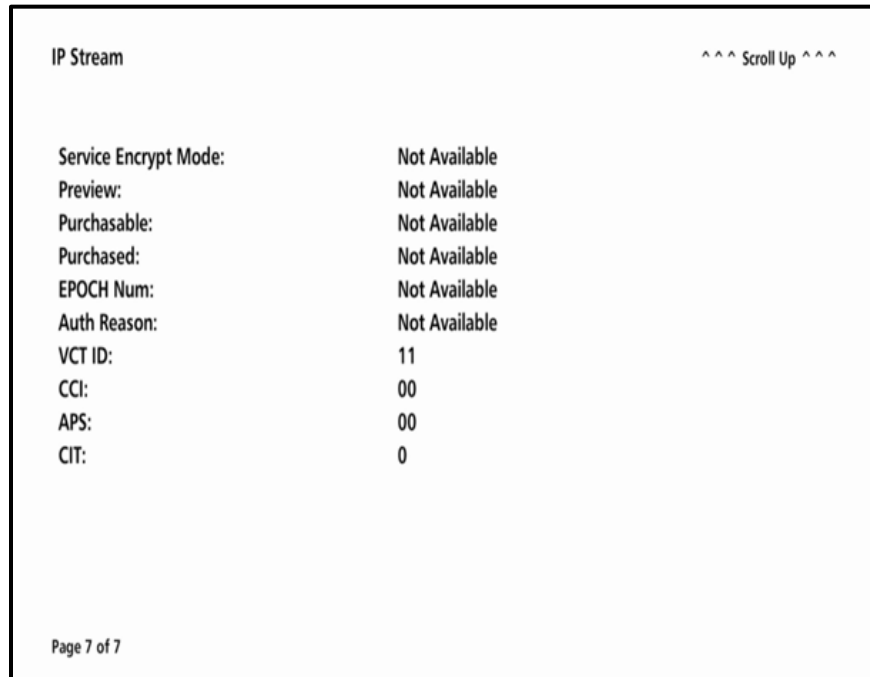

Table 21 – Current Channel Status- – IB Tuner ID Fields (Pages 1 & 2)

FIELD	DESCRIPTION
IB Tuner ID	Indicates the source of the current channel being reported: <ul style="list-style-type: none"> • Tuner 1 • Tuner 2 • Tuner 3 • Tuner 4 • Tuner 5 • Tuner 6 • IP Stream
The following information displays for each IB Tuner ID:	
ECN Data Present	Indicates if an Entitlement Control Message is detected for the acquired digital QAM service.
Virtual Channel Number	Indicates the Virtual Channel Number of the service acquired by that tuner.
Service Encrypt Mode	Indicates if the of the service acquired by that tuner is encrypted. Values include: <ul style="list-style-type: none"> • UNE - Unencrypted • CLR - Clear • ENC - Encrypted • FWK - Fixed Working Key • FPK – Fixed Program Key

FIELD	DESCRIPTION
Preview	Indicates whether the current program is in Preview mode
Purchasable	Indicates that the current program is available to be purchased for viewing
Purchased	Indicates that the current program was already purchased for viewing
EPOCH Num	Indicates the Identifier of the IPPV EPOCH.
Auth Reason	The service authorization reason is displayed in hexadecimal format.
VCT ID	Indicates the Virtual Channel Table provisioned for the product.
CCI	Copy control information: <ul style="list-style-type: none"> • 00 - Copy free • 01 - No more copies • 10 - Copy once • 11 - Never copy • N/A - Value is invalid or cannot be retrieved
APS	Analog Protection System; <ul style="list-style-type: none"> • 00 – No Macrovision • 11 – Type 3 Macrovision N/A - Value is invalid or cannot be retrieved
CIT	The constrained image trigger as delivered in the PRK or the Set DRM API: <ul style="list-style-type: none"> • 0 – Not set • 1 – Set N/A - Value is invalid or cannot be retrieved

d05 HTTP Adaptive Video Information

HTTP Adaptive Video Information	
Buffer Fullness:	N/A
Buffer Status:	N/A
Stream Type:	N/A
Acquisition Time:	N/A
Decoder Bitrate:	N/A
Download Segment Bitrate:	N/A
Playlist Name:	N/A
Sequence Number:	N/A
Segment Duration:	N/A
DRM Type:	N/A
Source IP:	N/A
Source Port:	N/A

Table 22 – HTTP Adaptive Video Information Fields

FIELD	DESCRIPTION
Buffer Fullness	Indicates the percent fullness of the buffer in the receiver.
Buffer Status	The status of the receiver buffer indicating if over-run or under-run is detected. Possible values: Overflow Underflow OK
Stream Type	The type of the stream received over the top. Examples are: HLS Progressive DL
Acquisition Time	Time taken to acquire the last segment, expressed in milliseconds. This is the time between the request and receipt of the last segment.
Decoder Bitrate	This parameter is from the video decoder and is the bitrate of the chunk or segment that was last pulled out of the buffer.
Download Segment Bitrate	This parameter is the transfer rate - the bit rate of the last chunk or segment it pulled down from the server.

FIELD	DESCRIPTION
Playlist Name	This playlist contains the variant playlist names for different bit rates.
Sequence Number	The sequence number of the segment which is currently being played.
Segment Duration	Duration of each chunk or segment expressed in milliseconds.
DRM Type	The type of DRM being used. Possible values: Secure Media AES N/A
Source IP	IP address of streamer server
Source Port	The port of streamer server that is being used for the OTT streaming.

d06 In Home Streaming Sessions

This diagnostic displays a status of the In Home Streaming Sessions, including sessions streaming into the VMS and sessions streaming out of the VMS to the IP Clients.

In Home Streaming Sessions: STREAMING-IN

Local IP Address:	192.168.71.135
Source IP:	N/A
Source Port:	N/A
Fail to Establish Secure Stream:	N/A
IP Client Rx Buffer Packet Count:	N/A
Platform Media Player Event Status:	N/A

Page 1 of 7 vvv Scroll Down vvv

In Home Streaming Sessions: STREAMING-OUT ^^^ Scroll Up ^^^

Stream Type:	LIVE
Destination IP:	192.168.71.139
Destination Port:	33425
Tuner ID:	0
TCP Retransmission Count:	0
Server (VMS) Buffer Overflow:	False
Server (VMS) Tx Buffer Packet Count:	0

Page 2 of 7 vvv Scroll Down vvv

Note: Additional Streaming Out pages will display for up to six tuners.

Table 23 – In Home Streaming Sessions – STREAMING-IN Fields (Page 1)

FIELD	DESCRIPTION
Local IP Address	IP address of the local device receiving the stream
Source IP	IP address of the streamer server for an incoming stream.
Source Port	Port of the streamer server that is being used for the current streaming session (incoming to the current STB).
Fail to Establish Secure Stream	This parameter indicates when a client device fails to set up a secure stream with a server. The client STB will set it to TRUE in case of failure. After a successful secure stream set up, it will be set to FALSE .
IP Client Rx Buffer Packet Count	Number of packets in the client buffer.
Platform Media Player Event Status	Status of the media player in the client device. Possible values: Playing Paused Stopped Trick Play

Table 24 – In Home Streaming Sessions – STREAMING-OUT Fields (Page 2 (up to 7))

FIELD	DESCRIPTION
Stream Type	Type of in-home stream. Possible values: LIVE - refers to QAM or IP tuning and live or LOD content VOD DVR
Destination IP	IP address of client if the current stream is an outgoing stream from the current STB.
Destination Port	Port of client that is being used for the current streaming session (outgoing from the current STB).
Tuner ID	Tuner number associated with the stream, if available (N/A for streams that are not associated with a tuner).
TCP Retransmission Count	Number of TCP packets that needed a retransmission since the last reboot. This parameter is meaningful for a serving session.
Server (VMS) Buffer Overflow	Indicates whether the server buffer has encountered overflow condition.
Server (VMS) TX Buffer Packet Count	Number of packets in the server buffer.

d07 Audio / Video Status

This diagnostic displays the Ethernet Return status. The information is updated each time this diagnostic is displayed.

Audio/Video Status	
SPDIF:	DD
Audio Mute:	False
Video Mute:	False
Input Source:	IB Tuner
Audio Mode:	STEREO
Input Format:	4:3 528x480 29

Table 25 – Audio / Video Status Fields

FIELD	DESCRIPTION
Audio SPDIF	<p>Indicates S/PDIF Mode as set by application software.</p> <ul style="list-style-type: none"> • N/A Audio S/PDIF mode is not applicable. • IEC958PCM PCM audio selected. • DD (Dolby Digital) For Dolby Digital selection, the following speaker selection is set: <ul style="list-style-type: none"> • 1/0 right front or left front. • 2/0 right front and left front. • 3/0 right front and left front and center. • 2/1 right front and left front and (right rear or left rear). • 3/1 right front and left front and center and (right rear or left rear). • 2/2 right front and left front and right rear and left rear. • 3/2 right front and left front and center and right rear and left rear
Audio Mute	<p>Audio Mute indicates if any of the audio outputs have been muted by the software, for example, selectable output control.</p>

FIELD	DESCRIPTION
Video Mute	The Video Mute indicates if any of the video outputs have been muted by the software, for example, selectable output control.
Input Source	<ul style="list-style-type: none"> • Input source for the audio and video, for example, IB Tuner.
Audio Mode	<p>Audio Mode indicates the audio Mode of in incoming digital service. Valid values include:</p> <ul style="list-style-type: none"> • N/A: the audio mode is not applicable to the currently tuned stream. • Mono: the audio mode is monophonic. • Stereo: the audio mode is stereo. • Surround: the audio mode is surround sound. • 5.1: the audio mode is Dolby Digital 5.1 surround sound. • 7.1: the audio mode is Dolby Digital 7.1.
Input Format	Includes the aspect ratio (4:3 or 16:9), the screen pixel size (nnnnXnnnn), pixel display (i for interlaced, p for progressive), and frames per second (24, 25, 30, 60).

d08 Memory Configuration

This diagnostic displays the VMS1100 series memory configuration. The information is updated when the diagnostic is displayed.

Note: The Memory Configuration table will increase and scroll to multiple pages depending on the number of processes detected.

Memory Configuration		
Total Memory:		1580 MB
Memory Free:		1321 MB
Total CPU Load:		8 %
% CPU and Memory per Process		
Process	CPU Load	Memory Usage
init	0.00%	0.09%
mocad	0.00%	0.65%
ntpd	0.00%	0.1%
telnetd	0.00%	0.09%
busyBoxEnable	0.00%	0.09%
start_lighttpd.	0.00%	0.09%
start_php.sh	0.00%	0.09%
start_platform.	0.00%	0.09%
procman	0.00%	0.34%
sh	0.00%	0.09%
php-cgi	0.00%	0.79%
halserver	5.50%	66.02%
Page 1 of 6		vvv Scroll Down vvv

Table 26 – Memory Configuration Fields

FIELD	DESCRIPTION
Total Memory	The allocated system RAM in MB
Memory Free	The size of free RAM memory expressed in megabytes (MB)
Total CPU Load	Total process load on the CPU
CPU Load Average Per Process	Average CPU load percentage per process
Memory Usage	RAM memory used per process (scroll down for more processes)

d09 Interface / Port Status

The Interface Status diagnostic displays when running in KreaTV. There is no front panel display. The information on the OSD is updated when you display the diagnostic.

Interface / Port Status	
DVI / HDMI	
Mode:	HDMI
Color Space:	YCC
Device Connected:	Yes
Video Xmission:	Muted
HDCP Enabled:	False
Output Format:	1920 x 1080i
Aspect Ratio:	16:9
EDID DATA	
1920x1080i:	Yes
1280x720p:	Yes
720x480p:	Yes
720x480i:	No
1920x1080p_24:	Yes
1920x1080p_30:	Yes
1920x1080p_60:	No
Page 1 of 2	vvv Scroll Down vvv

User Setting		^^^ Scroll Up ^^^
TV Type:	16:9	
Output Type:	1080i	
1080p Passthrough Enabled:	Off	
Closed Caption Enabled:	Yes	
CC Analog Service Selection:	CC3	
CC Digital Service Selection:	D1	
Detection of 3DTV Primary Formats		
Side by Side:	No	
Top Bottom:	No	
Other:	Yes	
HDMI Audio Output:	PCM	
HDMI Audio Rate:	48 kHz	
Page 2 of 2		

Table 27 – Interface Status -DVI/HDMI Fields (Page 1 of 2)

FIELD	DESCRIPTION
Mode	Indicates the connector mode: DVI or HDMI
Color Space	Indicates the color space used over the HDMI connection: YCC or RGB
Device Connected	<ul style="list-style-type: none"> Indicates whether a device is connected to the HDMI port: Yes or No.
Video Xmission	Video transmission — Indicates whether the VMS1100 is transmitting video over the HDMI port
HDCP Enabled	Indicates whether the VMS1100 is using HDCP to encrypt video transmitted over the HDMI link — Yes or No . If the Video Xmission status is Not Active, the HDCP Enabled status is No
Output Format	<p>Indicates the timing format of the video sent through HDMI:</p> <ul style="list-style-type: none"> 1920 x 1080p — 1920 pixels wide by 1080 pixels high, progressive 1920 x 1080i — 1920 pixels wide by 1080 pixels high, interlaced 1280 x 720p — 1280 pixels wide by 720 pixels high, progressive 720 x 480p — 720 pixels wide by 480 pixels high, progressive 720 x 480i — 720 pixels wide by 480 pixels high, interlaced 640 x 480p — 640 pixels wide by 480 pixels high, progressive
Aspect Ratio	Indicates the aspect ratio of the video sent through HDMI: 4:3 or 16:9 .
EDID DATA	<p>Indicates the video timing formats that were read from the Extended Display Identification Data (EDID) register for the connected device. In particular, the detailed timing description blocks. The list displays a selection of common formats that the TV or repeater supports that have been read by the Product.</p> <p>If the Product cannot read any formats, EDID Data is blank. An asterisk (*) after the aspect ratio means the Product supports the format.</p>

Table 28 – User Setting Fields (Page 2 of 2)

SETTINGS	DESCRIPTION
TV Type	<p>Indicates how the style of television connected to the product was set (16:9 or 4:3) and the preferred content control method (for example, Letterbox, pan and scan, undistorted)</p> <ul style="list-style-type: none"> • 16:9 designates that a widescreen television is connected to the set-top. • 4:3 LETTERBOX designates that a standard screen television is connected to the VMS set-top and that widescreen programs should be scaled to fit the screen with black bars above and below the picture. • 4:3 PAN SCAN designates that a standard screen television is connected to the VMS set-top and that widescreen programs should be cropped so that the picture fills the entire screen.
Output Type	<p>Allows you to specify the video output format of the VMS set-top for all content (when the 4:3 override setting is OFF) or for all 480p, 720p, and 1080i content (when the 4:3 override is used).</p> <p>Possible options:</p> <ul style="list-style-type: none"> • 1080p60 — High-Definition 1080p, 60 fps format (1920 x 1080 pixels). • 1080i — (Default option) High-Definition 1080i format (1920 x 1080 pixels). • 720p — High-Definition 720p format (1280 x 720 pixels) • 480p — Enhanced-Definition 480p format (720 x 480 pixels). • 480i — Standard-Definition 480i format (720 x 480 pixels).
1080p24 Passthrough Enabled	<p>Turns ON or OFF the passthrough of 1080p24 content directly to the TV.</p>
Closed Caption Enabled-	<p>Turns closed captions ON or OFF. The front panel display indicates the status of the closed captions.</p> <p>Possible options: Yes or No (default)</p>
CC Analog Service Selection	<p>Sets the analog service used for closed captions:</p> <ul style="list-style-type: none"> • CC1 (default), CC2, CC3, CC4, T1, T2, T3, or T4
CC Digital Service Selection	<p>Sets the digital service used for closed captions:</p> <ul style="list-style-type: none"> • D1 PRIMARY LANGUAGE (default) • D2 SECONDARY LANGUAGE • D3, D4, D5, or D6

SETTINGS	DESCRIPTION
Detection of 3DTV Primary Formats	Indicates if the 3D video timing formats are read from the Extended Display Identification Data (EDID) register for the connected device.
Side by Side	Indicates if 3D 'Side by Side' was detected: Yes or No
Top Bottom	Indicates if 3D 'Top Bottom' was detected: Yes or No
Other	Used for 2D for other formats in the EDID register.
HDMI Audio Output	Indicates the format of the audio: <ul style="list-style-type: none"> • PCM • DD • AAC
HDMI Audio Rate	Indicates the audio rate, for example: <ul style="list-style-type: none"> • 32 kHz • 44.1 kHz • 48 kHz • 96 kHz

d10 Current Sessions

Current Sessions	
OTT Stream:	0
Linear Recording:	0
Local Playback:	1
Remote Streaming:	0

Table 29 – Current Sessions Field

FIELD	DESCRIPTION
OTT Stream	<p>Number of over the top (OTT) HLS streams detected (0 or 1 session).</p> <p>If a host VMS goes offline, an OTT session will be started for clients connected to that VMS allowing connected clients to continue TV viewing.</p> <p>Note: An OTT session has a limited/scaled back channel map, so not all channels will be available for the IP clients.</p>
Linear Recording	Number of linear recording sessions set up.
Local Playback	<p>Number of local playback sessions: 0 or 1.</p> <p>If live session, will have LOD</p>
Remote Streaming	Number of remote streaming sessions to IP client STBs (live, recorded, or VOD).

d11 Connected Home

Elements included in the Connected Home system will appear in the status. This diagnostic displays the MoCA network status.

Connected Home	
Network Link Type:	MoCA
LAN MAC Address:	00:21:1e:d6:17:04
MoCA Link Status:	True
MoCA Connectivity Loss Count:	0
Ethernet Link Status:	True
Ethernet Connectivity Loss Count:	0
Additional Information >>>>	
MoCA Node Network	
MoCA Phy Rates	
MoCA Power and Attenuation Level	
MoCA Packet Counts	
MoCA QoS	
Ethernet H/W Configuration	
Registered Client List	
DHCP Link Status	
LAN and QoS	

Table 30 – Connected Home Fields

FIELD	DESCRIPTION
Network Link Type	Describes the link type: MoCA , Ethernet , or None The value is set to None to indicate that a connection is not established yet.
LAN MAC Address	MAC address assigned to the Local Area Network
MoCA Link Status	The status of the MoCA link. TRUE = Active FALSE = Inactive
MoCA Connectivity Loss Count	Number of time MoCA connectivity was lost since last boot.
Ethernet Link Status	The status of the Ethernet link. TRUE = Active FALSE = Inactive
Ethernet Connectivity Loss Count	Number of times Ethernet connectivity was lost since the last boot.

FIELD	DESCRIPTION
Additional Information	Selectable information screens for the following menu items: <ul style="list-style-type: none"> • MoCA Node Network • MoCA Phy Rates • MoCA Power and Attenuation Level • MoCA Packet Counts • MoCA QoS • Ethernet H/W Configuration • Registered Client List • DHCP Link Status • LAN and QoS

MoCA Node Network

MoCA Node Network		
RF Frequency:	1150 MHz	MoCA: 1.1 / 2.0
RF Password:	999999999888888888	
Number of Nodes in Network:	2	
Number of Nodes Connected to the Local Device:	1	
Local MoCA Node ID:	1	
Total Devices in Network :		
Node ID	MoCA MAC Address	Network Coordinator Indication
0	00:7f:28:0d:bb:2e	False
1*	00:21:1e:d6:17:04	True

Table 31 – Connected Home – MoCA Node Network Fields

FIELD	DESCRIPTION
RF Frequency	Displays the frequency of the MoCA RF channel in use by the set-top: 1150 (default) to 1500 MHz
MoCA: Network/Local Version	Network and Local MoCA version IDs in the format NN/LL: <ul style="list-style-type: none"> • NN is the 2-digit Network MoCA version • DHCP is the 2-digit Local MoCA node version

FIELD	DESCRIPTION
RF Password	MoCA RF Password. Default is 999999999888888888
Number of Nodes in Network	Total number of nodes (i.e., devices) residing on the MoCA network.
Number of Nodes Connected to the Local Device	Total number of MoCA nodes/devices connected to the local node.
Local MoCA Node ID	<p>MoCA assigned node ID of the set top.</p> <ul style="list-style-type: none"> • mocaNodeID will range from 0-7 for devices in the MoCA 1.0 network • mocaNodeID will range from 0-15 for devices in the MoCA 1.1 or 2.0 network
Total Devices in Network	<p>List of the MoCA MAC address for each node in the network and indication of the Network Coordinator:</p> <ul style="list-style-type: none"> • Node ID: MoCA-assigned node ID associated with the connected device. The NodeID ranges from 0-7 for devices in the MoCA 1.0 network. The NodeID ranges from 0-15 for devices in the MoCA 1.1 or 2.0 network • MoCA MAC Address: MoCA layer MAC address used for the Phy level home network connection. • Network Coordinator Indication: Shows which node in the MoCA network is acting as the Network Coordinator.

MoCA Tx and Rx Phy Rates

MoCA Tx and Rx Phy Rates		
Node ID	Tx Phy Rate(Mbps)	Rx Phy Rate(Mbps)
0	233.00	245.00
1*	***	***

Table 32 – Connected Home – MoCA Tx and Rx Phy Rates Fields

FIELD	DESCRIPTION
Phy Rate Table	<p>Table of the Phy Rates associated with each node in the MoCA network and any associated warning indications:</p> <ul style="list-style-type: none"> • Bw: Node has a link supporting less than 100 Mbps (the associated BHR RF LED will also blink). • Fr: Node received significant packet errors caused by thermal noise or interfering signals. • Pw: There is insufficient power at the node.
Tx Phy Rate	The physical layer transmit rate of the STB being polled to the connected node (indicated by node ID), expressed in Mbps.
Rx Phy Rate	The physical layer receive rate by the STB being polled from the connected node (indicated by nodeID), expressed in Mbps.

MoCA Power and Attenuation Level

MoCA Power and Attenuation Level			
Node ID	Tx Atten Level (dB)	MoCA Tx Power (dBm)	MoCA Rx Power (dBm)
0	22	-19	-50
1*	0	0	0

Table 33 – Connected Home – MoCA Power and Attenuation Level Fields

FIELD	DESCRIPTION
MoCA Power and Attenuation Level Table	Table of the Attenuation and Power associated with each node in the MoCA network
Tx Attenuation Level	MoCA transmit attenuation level (dB) for each direct link between the local device and each MoCA node on the MoCA network, if available.
MoCA Tx Power	The RF transmit power level at the connected MoCA node expressed in dBm for the link between the connected node and the STB being polled.
MoCA Rx Power	The RF receive power level at the STB being polled expressed in dBm for the link between the connected node and the STB being polled.

MoCA Rx Packet Count

MoCA Rx Packet Count				
Node ID	Rx Packet Count	PER Window	Uncorrectable PER	Uncorrectable Packet Count
0	3	60	0 E-7	0
1*	0	60	0 E-7	0

Table 34 – Connected Home – MoCA Rx Packet Count Fields

FIELD	DESCRIPTION
MoCA Packet Count and PER Table	Table of the Rx Packet Count, Packet Error Rate, and number of Uncorrectable Packets associated with each node in the MoCA network
Rx Packet Count	MoCA received packet count for each direct link between the local device and each MoCA node on the MoCA network, if available.
PER Window	Window time in minutes for PER calculation. Expected range: 60 to 240 minutes . Window will be considered as t minutes in the past up to the current time.
Uncorrectable PER	This parameter indicates the fraction of received packets that could not be corrected for the time period within PER Window. The value is expressed in 10-7. For example, the value 5 will represent the PER 5E-7 .
Uncorrectable Packet Count	MoCA received uncorrectable packet count for each direct link between the local and each MoCA node on the MoCA network, if available.

MoCA Priority QoS

MoCA Priority QoS		
Traffic Type	Priority LAN	DSCP Mark
Best Effort	N/A	0x00(Class 0)
AV Stream	5	0x28(Class 5)
AV Control	7	0x38(Class 7)

Table 35 – Connected Home – MoCA Priority QoS Fields

FIELD	DESCRIPTION
MoCA Priority QoS Table	Table of the Traffic Type and associated Priority LAN and DSCP Mark
Traffic Type	Traffic type that is to be tagged.
Priority LAN	The priority code point setting of a particular traffic type as defined by IEEE 802.1p. Possible values: <ul style="list-style-type: none"> • 0-7 • N/A indicates Priority is Not Assigned
DSCP Mark	DSCP value to be used.

Ethernet Hardware Configuration

Ethernet Hardware Configuration	
Ethernet MAC Address:	00 21 1e d6 17 03
Driver Loaded:	True
Flow Control:	False
Jumbo Packet:	False
Link Speed:	1000
Link Duplex:	True

Table 36 – Connected Home – Ethernet Hardware Configuration Fields

FIELD	DESCRIPTION
Ethernet MAC Address	MAC Address used for the Ethernet connection.
Driver Loaded	This parameter indicates whether the Ethernet driver is loaded. Possible values: <ul style="list-style-type: none"> • True = Loaded • False = Not loaded
Flow Control	This parameter indicates whether flow control has been enabled. Possible values: <ul style="list-style-type: none"> • True = Enabled • False = Disabled
Jumbo Packet	This parameter indicates whether Jumbo packets have been enabled. Possible values: <ul style="list-style-type: none"> • True = Enabled • False = Disabled
Link Speed	The link speed expressed in Mbps. Possible values: 10, 100 and 1000
Link Duplex	This parameter indicates whether Duplex mode is enabled (after auto negotiation) for the link. Possible values: <ul style="list-style-type: none"> • True = Enabled • False = Disabled

Registered Client List (IP Client)

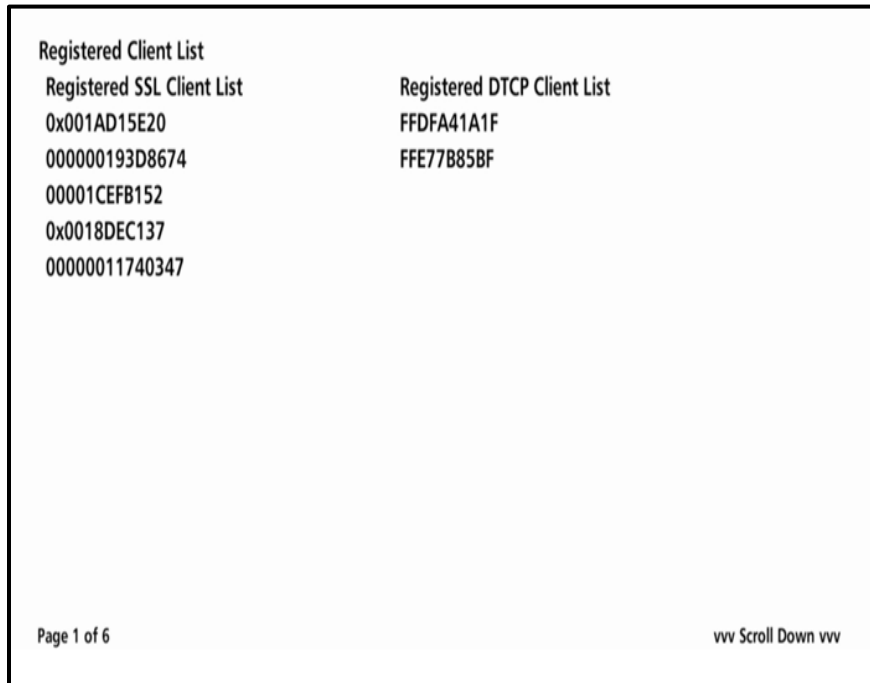

Table 37 – Connected Home – Registered Client List Fields

FIELD	DESCRIPTION
Registered SSL Client List	Comma-separated list of SSL Device IDs of the registered IP client STBs. An updated list must be supplied when an IP client is added or removed
Registered DTCP Client List	Comma-separated list of DTCP IP Device IDs of the registered IP client STBs. An updated list must be supplied when an IP client is added or removed (scroll down the list as the number of registered clients increase).

DHCP Link Status

DHCP	
IP Address:	192.168.71.135
Subnet Mask:	255.255.255.0
IP Address Lease Time:	Wed Apr 10 2013 12:01:58 GMT-0400
Time Remaining:	21102
IP Address Renewal Attempt Count:	2
IP Address Renewal Success Count:	1
Renew Lease Control:	False
BHR IP Address:	192.168.71.1
BHR DNS 1 IP Address:	192.168.71.1
BHR DNS 2 IP Address:	N/A

Table 38 – Connected Home – DHCP Link Status Fields

FIELD	DESCRIPTION
IP Address	IP Address of either the Ethernet or MoCA IP device, depending on the link type.
Subnet Mask	Subnet Mask of the device.
IP Address Lease Time	Date and time (local time) when the IP address was assigned by the BHR.
IP Address Lease Time Remaining	Time (expressed in seconds) remaining before the IP lease expires.
IP Address Renewal Attempt Count	The number of times the IP Address was attempted for renewal since the last reboot.
IP Address Renewal Success Count	The number of times the IP Address was renewed successfully since the last reboot.
Renew Lease Control	Also known as the DHCP Renew Lease Control. This indicates if the IP Lease will be broken to force the device to reacquire an IP address.
BHR IP Address	IP Address of the BHR from the DHCP interaction.
BHR DNS 1 IP Address	IP Address of the DNS server from the DHCP interaction.
BHR DNS 2 IP Address	IP Address of a second DNS server, if detected from the DHCP interaction.

LAN and QoS

LAN and QoS		
Wake On LAN:		FALSE
VLAN / QoS Status:		TRUE
Ethernet Priority QoS		
Traffic Type	Priority LAN	DSCP Mark
Best Effort	N/A	0x00(Class 0)
AV Stream	5	0x28(Class 5)
AV Control	7	0x38(Class 7)

Table 39 – Connected Home – LAN and QoS Fields

FIELD	DESCRIPTION
Wake On LAN	Indicates whether the WOL feature is enabled. Possible values: <ul style="list-style-type: none"> • True = Enabled • False = Disabled
Status VLAN/QoS	Indicates whether VLAN 802.1p status is enabled. Possible values: <ul style="list-style-type: none"> • True = Enabled • False = Disabled
Ethernet Priority QoS Table	Table of the Traffic Type and associated Priority LAN and DSCP Mark
Traffic Type	Traffic type that is to be tagged.
Priority LAN	Priority code point setting of a particular traffic type as defined by IEEE 802.1p. Possible values: <ul style="list-style-type: none"> • 0-7 • N/A indicates Priority is Not Assigned Possible
DSCP Mark	DSCP value to be used.

d12 Purchase / Poll Status

This diagnostic displays the status of subscriber event purchases on the OSD and front panel. The displays are updated each time this diagnostic is viewed.

Purchase / Poll Status	
Purchases Balance	
Purchases Balance:	10
Unsent:	00
Unack:	00
Last Seq Num:	33168
Last RB Time:	N/A
IPPV Status	
Credit Balance:	10010
Last Poll Status	
Prep Command:	N/A
	N/A
Prep ACK:	N/A
	N/A
Poll Request:	N/A
	N/A
Poll ACK:	N/A
	N/A

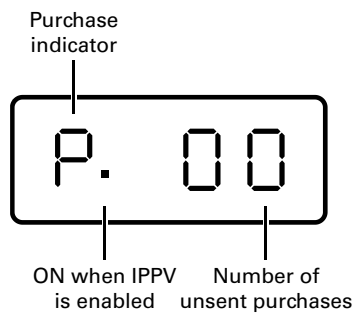



Table 40 – Purchase / Poll Status Fields

FIELD	DESCRIPTION
Purchases Balance	Purchases balanced configured by the headend. The purchases balance is the number of purchases that can be made.
Unsent	The number of purchases in the VMS remaining to be polled. It can be an integer from 0 to 63.
Unack	The number of reports that have not been acknowledged by the controller. It is an integer.
Last Seq Num	The last acknowledged sequence number of a purchase sent by the controller. It is a 16-bit, unsigned hexadecimal number.
Last RB Time	The last time the Product attempted to report back purchases to the controller, in GPS seconds.
IPPV Status	If IPPV is enabled, the IPPV status indicator is ON . If IPPV is disabled, the IPPV status indicator is OFF .
Credit Balance	Credit available for IPPV Purchase.
Last Poll Status:	
Prep Command	“Last Prepare for Poll Command” sequence number and time of the last prepare for poll request command that was sent by the controller. Note that each requesting process maintains an independent sequence of poll requests to uniquely identify the poll responses.
Prep ACK	“Last Prepare for Poll Acknowledge” sequence number and time of the last Report Purchase request sent by the controller.
Poll Request	Sequence number and time of the last send poll buffer command that was sent by the controller.
Poll Acknowledge	Sequence number and time of the last Poll Acknowledge message sent by the controller.

d13 IN BAND Status

This diagnostic displays the in-band status for the last attempted tuned channel. The information is updated every five seconds.

Inband Status	
Inband Tuner 1	
Mode:	QAM64
Carrier Lock:	True
Carrier Loss Lock Count:	0
PCR Lock:	True
Data Detection:	True
Frequency:	555 MHz
SNR Value:	23.3 dB
SNR Quality Indicator:	POOR
Signal Level/Received Power:	-28



Page 1 of 12 vvv Scroll Down vvv

Note: Additional information is available for the remaining five tuners on pages 3 thru 12. Scroll down to display for each additional tuner.

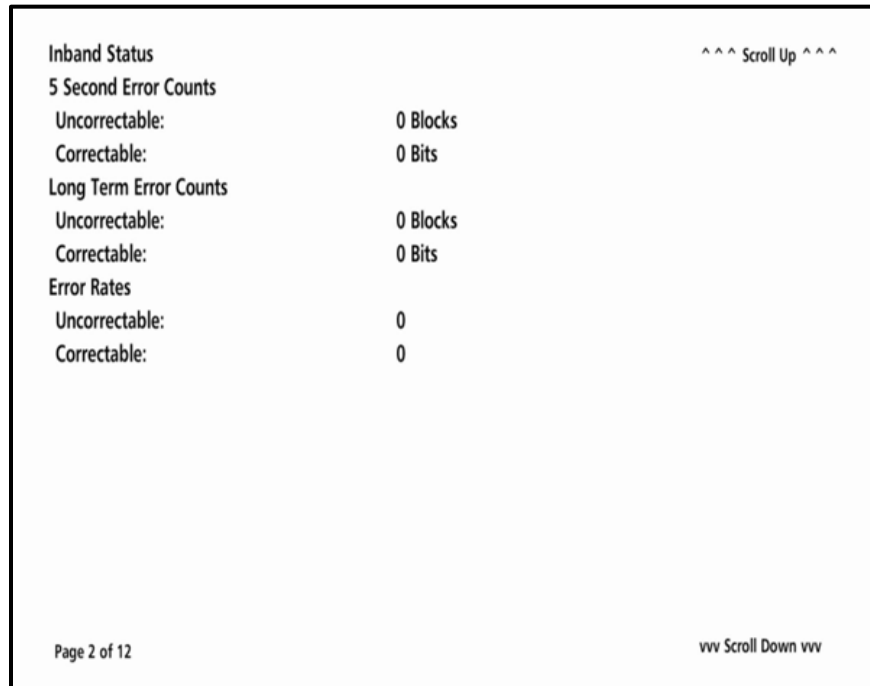

Table 41 – In Band Status Fields (Page 1)

FIELD	DESCRIPTION									
Mode	The values displayed on the OSD are: <ul style="list-style-type: none"> • 64 QAM — 64 QAM digital channel • 256 QAM — 256 QAM digital channel 									
Carrier Lock	Indicates whether the in-band receiver is locked to the carrier. If a digital carrier is not present, it indicates the carrier is not locked: <table border="1" data-bbox="678 1220 1386 1409"> <thead> <tr> <th>OSD</th> <th>Front Panel Indicator</th> <th>Description</th> </tr> </thead> <tbody> <tr> <td>YES</td> <td>L</td> <td>Carrier locked</td> </tr> <tr> <td>NO</td> <td>U</td> <td>Carrier unlocked</td> </tr> </tbody> </table>	OSD	Front Panel Indicator	Description	YES	L	Carrier locked	NO	U	Carrier unlocked
OSD	Front Panel Indicator	Description								
YES	L	Carrier locked								
NO	U	Carrier unlocked								
Carrier Loss Lock Count	Indicates the cumulative number of times the inband tuner has lost lock on the inband frequency since last the tune.									
PCR Lock	Indicates whether the in-band receiver is locked to the current program clock reference for a digital video service on the specified tuner. If a digital carrier is not present, it indicates the PCR is not locked.									
Data Detection	Indicates whether data is being carried on the in-band stream. The indicators cover all packet processors regardless of the stream they are monitoring: <table border="1" data-bbox="678 1793 1386 1850"> <thead> <tr> <th>OSD</th> <th>Front Panel Indicator</th> <th>Description</th> </tr> </thead> <tbody> </tbody> </table>	OSD	Front Panel Indicator	Description						
OSD	Front Panel Indicator	Description								

FIELD	DESCRIPTION
	<p>YES ON In-band data detected within last 5 seconds</p> <hr/> <p>NO OFF In-band data not detected within last 5 seconds</p>
Frequency	The in-band frequency is center RF carrier frequency tuned for the digital service on the specified tuner. The frequency is displayed in MHz in xxxx.xxx format and ranges from 54 to 860 MHz .
SNR Value	When carrier lock has been established, displays an estimate of the carrier signal-to-noise ratio in dB.
SNR Quality Indicator	<ul style="list-style-type: none"> • GOOD — Good value • FAIR — Marginal signal level, check the signal • POOR — Unusable signal • INVALID — Invalid SNR value
Signal Level/Received Power	Indicates the number of correctable and uncorrectable digital multiplex errors, up to 9999 . It is updated every 5 seconds and reset each time the VMS1100 series is power cycled or another digital multiplex is tuned. The maximum value displayed is 9999 , even if there were more than 9999 errors.

Table 42 – In Band Status Fields (Page 2)

FIELD	DESCRIPTION
5 Second Error Counts	Indicates the number of correctable and uncorrectable digital multiplex errors. It is updated every 5 seconds and reset each time the Product is power cycled or another digital multiplex is tuned. The maximum value displayed is 9999 , even if there were more than 9999 errors.
Long Term Error Counts	Indicates the number of correctable and uncorrectable digital multiplex errors in the digital multiplex either since the last tune or over the last 24 hours.
Error Rates	Indicates the estimated error rates for Uncorrectable Blocks and Correctable Bits. Rates are displayed as a cumulative calculated value from either the last tune or over the last 10 minutes, whichever interval is shorter.

d14 Out-of-Band (OOB) Status

This diagnostic indicates the out-of-band control channel status. The information is updated every five seconds.

OOB Status	
OOB Status:	Active
OOB Frequency:	75.25 MHz
Carrier Lock:	True
Carrier Lock Loss Count:	0
Data:	True
EMM Data:	False
SNR:	23.2 dB GOOD
EMM Provider ID:	0x0001
EMM PID:	0x1503
Network PID:	0x0777
Signal Level/Received Power:	-25
Hunt Mode:	Hunted
LKC:	75.25 MHz
Man. Freq:	75.25 MHz

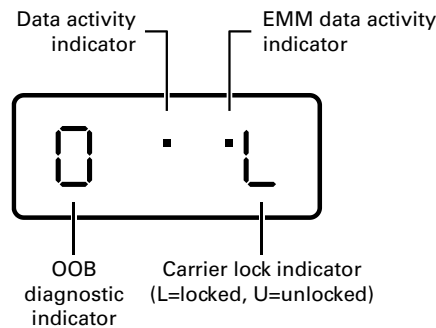

Table 43 – Out-of-Band Status Fields

FIELD	DESCRIPTION
OOB Status	Indicates if the control channel is activated from both head-end connect and ACS activation.
OOB Frequency	Indicates the OOB tuner center frequency, from 70 to 130 MHz.

FIELD	DESCRIPTION									
Carrier Lock	Indicates whether the OOB receiver is locked to the carrier:									
	<table border="1"> <thead> <tr> <th>OSD</th> <th>Front Panel</th> <th>Description</th> </tr> </thead> <tbody> <tr> <td>True</td> <td>L</td> <td>Carrier locked</td> </tr> <tr> <td>False</td> <td>U</td> <td>Carrier unlocked</td> </tr> </tbody> </table>	OSD	Front Panel	Description	True	L	Carrier locked	False	U	Carrier unlocked
OSD	Front Panel	Description								
True	L	Carrier locked								
False	U	Carrier unlocked								
Carrier Lock Loss Count	Indicates the cumulative number of times the OOB tuner has lost lock since the last reboot.									
Data	Indicates whether data is being carried by the OOB and EMM traffic, which is tracked separately:									
	<table border="1"> <thead> <tr> <th>OSD</th> <th>Front Panel</th> <th>Description</th> </tr> </thead> <tbody> <tr> <td>YES</td> <td>ON</td> <td>OOB data detected within last 5 seconds</td> </tr> <tr> <td>NO</td> <td>OFF</td> <td>OOB data not detected within last 5 seconds</td> </tr> </tbody> </table>	OSD	Front Panel	Description	YES	ON	OOB data detected within last 5 seconds	NO	OFF	OOB data not detected within last 5 seconds
OSD	Front Panel	Description								
YES	ON	OOB data detected within last 5 seconds								
NO	OFF	OOB data not detected within last 5 seconds								
EMM Data	Indicates whether EMM data is being carried on the OOB stream:									
	<table border="1"> <thead> <tr> <th>OSD</th> <th>Front Panel</th> <th>Description</th> </tr> </thead> <tbody> <tr> <td>YES</td> <td>ON</td> <td>EMM data detected within last 5 seconds</td> </tr> <tr> <td>NO</td> <td>OFF</td> <td>EMM data not detected within last 5 seconds</td> </tr> </tbody> </table>	OSD	Front Panel	Description	YES	ON	EMM data detected within last 5 seconds	NO	OFF	EMM data not detected within last 5 seconds
OSD	Front Panel	Description								
YES	ON	EMM data detected within last 5 seconds								
NO	OFF	EMM data not detected within last 5 seconds								
SNR	<p>When carrier lock has been established, displays an estimate of the carrier signal-to-noise ratio in dB, with an explanation:</p> <ul style="list-style-type: none"> • GOOD — Good value • FAIR — Marginal signal level, check the signal • POOR — Unusable signal • INVALID — Invalid SNR value 									
EMM Provider ID	Displays the conditional access stream for the VMS1100 series, in hexadecimal.									
EMM PID	Displays the packet identifier (PID) stream the VMS1100 series tunes to for EMM data, in hexadecimal.									
Network PID	Displays the network PID to which the VMS1100 is tuned to receive network messages, in hexadecimal.									
Signal Level/Received Power	Indicates the estimated received power for that frequency in dBmV.									

FIELD	DESCRIPTION
Hunt Mode	The hunt mode includes Hunted, None, Round Robin (RR), Search (SRCH), Fixed Frequency (FIX), or EMM Provider ID (EMM).
LKC	<p>The last known carrier is the last valid OOB frequency displayed in MHz and ranges from 70 to 130 MHz, with the specific values of: 75.25, 104.20, 72.75, 92.25, 98.25, 107.25, 107.40, 110.25, 116.25, and 103.75.</p> <p>LKC will remain blank during hunting if a valid carrier has not been found, and will be populated once a valid OOB is found.</p>
Man Freq	Only displayed when VMS1100 series is not hunting and the operator presses "menu" button. The operator can then scroll up or down to one of the specific OOB frequencies.

d15 DVR/Hard Drive Status

This two-page diagnostic displays the DVR and hard drive status.

DVR Status	
Record Capacity:	996916 MB
Number of Installed Drives:	1
Hard Drive Status	
Drive Location:	Internal
Model Number:	ST1000VM002-1CT162
Device ID:	W1G08VYQ
Type:	Internal
Total Size:	1000 GB
State:	Active
Max Temp:	100F 38C
Temp:	100F 38C
Over Temp:	No
Over Temp Count:	0
Number of Partitions:	2

Page 1 of 3 vvv Scroll Down vvv

Hard Drive Partitions 1		^^^ Scroll Up ^^^
Partition Name:	gpfs	
Size of Each Partition:	3288 MB	
Size of Free Space per Partition:	3117 MB	
Size of Used Space per Partition:	171 MB	
SMART Values		
Reallocated Sector Count:	107	
Reallocated Sector Count Threshold:	N/A	

Page 2 of 3 vvv Scroll Down vvv

Hard Drive Partitions 2		^^^ Scroll Up ^^^
Partition Name:	storage	
Size of Each Partition:	996916 MB	
Size of Free Space per Partition:	993032 MB	
Size of Used Space per Partition:	3883 MB	
SMART Values		
Reallocated Sector Count:	117	
Reallocated Sector Count Threshold:	N/A	

Page 3 of 3

Table 44 – DVR Status Fields (Page 1 of 3)

FIELD	DESCRIPTION
Record Capacity	Recording capacity, in bytes.
Number of Installed Drives	Number of internal and external hard drives.
Hard Drive Status	
Drive Location	Identification number sequentially assigned to each installed drive and whether the drive is Internal or External.
Model Number	Drive model number assigned at the factory.
Device ID	A text string of up to 20 characters that identifies the disk drive; "N/A" is displayed if the value is invalid or cannot be retrieved.
Type	Drive type: Internal or External
Total Size	Drive size in decimal GB. (1 decimal GB = 1x109 bytes. For example, 120 decimal GB = 120x109 bytes).
State	Hard drive state: Standby — The hard drive is working normally, but is at rest (the State returns to Active any time disc access is necessary). Active — The hard drive is accessing data. Failed — The hard drive hardware has failed.

Hard Drive Status (Continued)

FIELD	DESCRIPTION
Max Temp	For an internal hard drive only, its maximum temperature in degrees F.
Temp	For an internal hard drive only, its temperature in degrees F.
Over Temp	Indicates whether the drive is excessively hot: Yes — The internal drive temperature exceeds 140° F (60° C). The front panel Over-Temp Indicator is on and remains lit until the next over-temp sample is taken (at least once an hour). No — There is no over-temp problem.
Over Temp Count	The cumulative number of times that the hard drive temperature has been measured over 60° C, with the temperature checked at least once an hour.
Number of Partitions	The total number of partitions on the hard drive.

Table 45 – Hard Drive Partitions Fields (Pages 2 & 3)

FIELD	DESCRIPTION
Partition Name	Volume name for the partition assigned in software, for example, GPFS, or Storage or Partitions.
Size of Each Partition	The space used and allocated in MB for each of the internal hard drive's partitions.
Size of Free Space per Partition	The free space in MB for each of the internal hard drive's partitions.
Size of Used Space per Partition	The used space in MB for each of the internal hard drive's partitions
SMART Values	The SMART values and thresholds for the Hard Drive, if SMART is enabled.
Reallocated Sector Count	SMART (Self-Monitoring, Analysis and Reporting Technology) reallocated sector count value read from the drive
Reallocated Sector Count Threshold	The threshold assigned for use in the SMART Threshold Exceeds Condition, if available.

d16 WAN Network

WAN Network Status	
Failed Inform Count:	0

Table 46 – WAN Network Fields

FIELD	DESCRIPTION
Failed Inform Count	Indicates the number of failed inform attempts since the last successful Inform.

d17 Keypad Status

This diagnostic verifies the functionality of the front panel indicators and the front panel keypad. Each highlighted character corresponds with a front panel key press.

The front panel key presses should also highlight the corresponding character and a front panel indication. Also, a segment on the front panel 7-segment display should illuminate with each press of a front panel key.

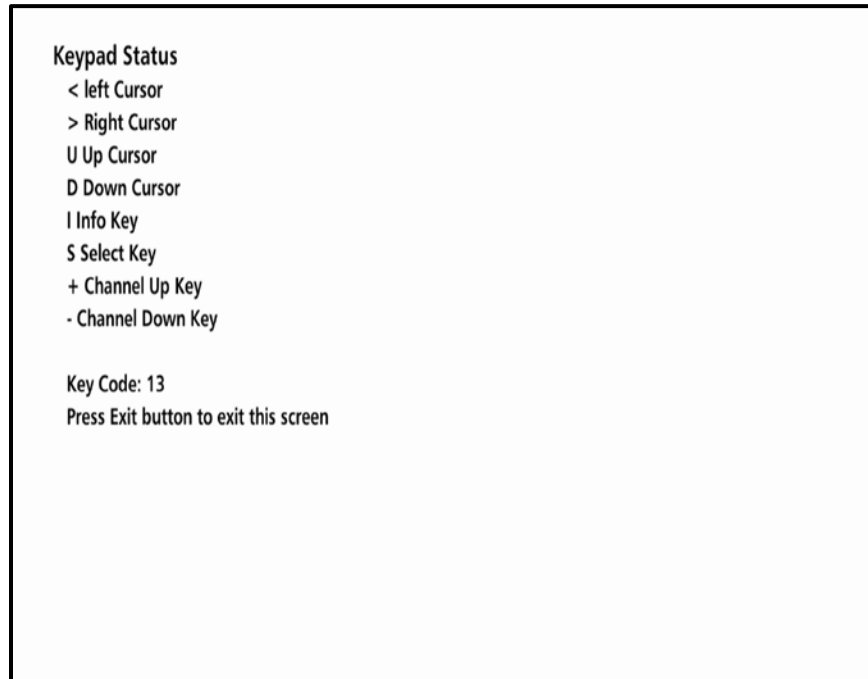

Table 47 – Keypad Status Fields

FIELD	DESCRIPTION
Key Code	Indicates the key code of a front panel key or an IR Key press.

5

Troubleshooting

See the troubleshooting guidelines listed below for a possible solution to the problem you are experiencing with the installation. If the problem is not resolved after performing the diagnostics, contact the TSCC for assistance (see [Getting Help](#) for more information).

Table 48 – Troubleshooting Guidelines

PROBLEM	POSSIBLE SOLUTION
The VMS will not power ON	<p>The VMS1100 may have received a software update and may not power ON while the new software is being installed. Try again in a few minutes.</p> <ul style="list-style-type: none"> • Verify that the AC power cord is connected to the VMS set-top and an AC outlet. Unplug the VMS set-top from the AC outlet, plug it back in, and then press the POWER button. • If the VMS set-top is connected to a switched outlet on another unit, verify that that unit is powered on. Unplug the power cord from the VMS1100 AC outlet, plug it back in, and then press the POWER button. It is recommended that you use an unswitched outlet, if possible. • Press the POWER button on the VMS1100 front panel instead of the remote control. The batteries in the remote control may be depleted.
The remote control does not work	<ul style="list-style-type: none"> • Verify that the remote control is in “STB” mode. • Verify that there are no obstructions between the remote control and the VMS. Aim the remote control directly at the VMS1100 front panel, not the TV or VCR. • The angle between the remote control and the VMS1100 may be too large. Stand in front of the VMS1100 and not too far to either side. • Press and release operation keys one at a time, firmly and deliberately. • Try changing channels using the buttons on the VMS1100 front panel. • Check the batteries in the remote control. Install new batteries if needed.
There is no audio when viewing cable channels	<ul style="list-style-type: none"> • Verify that the mute button on the VMS1100 or the remote control has not been pressed. Press MUTE on the remote control to restore sound. • If the VMS1100 audio output is connected to the TV, verify that the mute button on the TV has not been pressed. • If the VMS1100 audio output is connected to a home theater receiver, verify that the receiver is set to the appropriate input source and the mute button on the receiver has not been pressed. • Verify that you have the correct cables for the audio

PROBLEM	POSSIBLE SOLUTION
	<p>connections.</p> <ul style="list-style-type: none"> • Verify that the audio cables are firmly connected between the VMS1100 and the audio playback device (TV, receiver, DVD player, etc.).
<p>There is no audio from the center and/or surround speakers of a home theater receiver connected to the VMS</p>	<p>Not all Dolby® Digital programs feature full 5.1 surround sound. In some cases, the programs may only contain left and right stereo audio.</p> <ul style="list-style-type: none"> • Verify that the S/PDIF cable (coaxial or optical) is firmly connected to the VMS1100 and the home theater receiver. • Verify that the home theater receiver is set to a surround sound audio mode (Dolby Digital, Dolby Pro Logic II®, Dolby Pro Logic®). • Verify that the receiver is properly configured to work with all connected speakers.
<p>There is no video on the TV screen</p>	<ul style="list-style-type: none"> • Verify that the TV is powered on and set to the appropriate input source for the VMS. • Verify that the VMS1100 is powered on and tuned to an authorized cable channel. • Verify that all video cables between the VMS1100 and the TV are firmly connected. • Verify that the coaxial cable feed is firmly connected to the VMS1100 and the wall jack. • If the VMS1100 video output is connected to a home theater unit, verify that the home theater unit is powered on and set to the appropriate input source. • If the VMS1100 video output is connected to a TV through an HDMI connection, power OFF the TV and then power OFF the VMS1100 set-top. Wait one second and then power ON the devices.
<p>There is no video on the TV screen (continued)</p>	<p>Not all HDTVs can display every output format (1080i, 720p, 480p, or 480i) available on the VMS1100. To select a different format:</p> <ul style="list-style-type: none"> • Ensure that your VMS1100 is plugged into a power outlet and is turned off. • Ensure the TV is turned ON and tuned to the appropriate channel for the set-top • Press the MENU key on the front panel. Your settings are displayed on the VMS1100 front panel display. • Use the ▲ and ▼ keys on the front panel to display the HDMI/YPbPr OUTPUT setting. • Press the ► key to cycle through the available output formats until a picture displays on the TV.
<p>No graphics or program guides appear on the TV screen</p>	<p>If you use the IEEE-1394 connection, on-screen graphics, including closed captions and program guides, are not displayed by the VMS. On-screen graphics and captions may still be overlaid by your TV, if enabled. Alternatively, use HDMI or component video instead.</p>

PROBLEM	POSSIBLE SOLUTION
<p>No closed captions display</p>	<ul style="list-style-type: none"> • Verify on the User Settings menu that closed captions are enabled on the VMS1100 set-top. • Verify that closed captions are enabled on the TV. <p><i>Note: Closed captioning may not be available on the current program.</i></p>
<p>There are black bars to the right and left of the picture</p>	<p>Widescreen TVs display 4:3 programs in this format unless set to Stretch. Turn ON the 4:3 OVERRIDE feature in the User Settings menu. This enables most widescreen TVs to stretch the video to fill the screen (see your TV manual for information about stretching 4:3 video).</p> <ul style="list-style-type: none"> • If the VMS set top is connected to a widescreen TV, verify that the TV TYPE is set to 16:9 in the User Settings menu. <p>Many HD programs are broadcast in pillar-box format with black bars to the left and right of the picture. These programs are broadcast in 16:9 HD formats, even though the video is not 16:9.</p>
<p>There are black bars above and below the picture</p>	<p>All 4:3 HDTVs display HD programs in letterbox format (black bars above and below the picture) because of the shape of the display screen.</p> <ul style="list-style-type: none"> • Turn ON the 4:3 OVERRIDE feature in the User Settings menu. This enables most standard screen TVs to display a full screen picture when the VMS1100 set top is tuned to a 4:3 program. • Set the TV TYPE to 4:3 Pan-Scan. This enables the VMS set top to remove the black bars above and below the picture when possible. <p>Some SD programs are broadcast in the letterbox format with black bars above and below the picture. Some widescreen TVs offer a zoom feature that may be able to remove the black bars (see your TV manual for information about zooming 4:3 video).</p>
<p>There are black bars on all four sides of the picture</p>	<p>This may occur on a 4:3 TV if the 4:3 OVERRIDE setting is OFF. To set 4:3 SD programming to fill the screen, depending on the capabilities of the TV, set 4:3 OVERRIDE to 480i or 480p.</p> <p>This may occur on a 16:9 TV if the active video for an SD broadcast is in letterbox format. To confirm, wait for a commercial or look for a graphic, such as a network logo. If the commercial fills the screen from top to bottom, or the graphic appears below the active video, the program is being letterboxed by the broadcaster. You can minimize this by activating the zoom feature on the TV.</p> <p>A broadcaster may include black bars on either side of a widescreen broadcast. This is called a “hybrid” aspect ratio and results in a black border surrounding the video on a 4:3 TV. Because this is part of the broadcast, the VMS set top cannot correct the video. You may be able to minimize the border using the zoom feature on the TV.</p>
<p>Colors do not appear correctly</p>	<p>Be sure to match up each signal to the same YPbPr connection on the TV. Otherwise, colors will not appear correctly on your TV.</p>

PROBLEM	POSSIBLE SOLUTION
The VMS set-top is making a humming noise	The VMS1100 includes an integrated hard drive and a fan for cooling. During normal operation, the VMS1100 emits a low humming noise, similar to a personal computer. The noise varies in volume occasionally when the speed of the internal fan adjusts to changes in the temperature around the VMS set-top. Please note the hard drive will stay on even when the VMS1100 is turned off (standby).



Definitions, Acronyms and Abbreviations

Table 49 – Definitions, Acronyms and Abbreviations

ACRONYM	DESCRIPTION
AV	Audio/Video
BUI	Basic User Interface
DG	Dreamgallery
DHCP	Dynamic Host Configuration Protocol
DNS	Domain Name Service
DRAM	Dynamic Random Access Memory
EDID	Extended Display Identification Protocol
FQDN	Fully Qualified Domain Name
HDCP	High-bandwidth Digital Content Protection
HDD	Hard Disk Drive
HDMI	High-Definition Multimedia Interface
ICMP	Internet Control Message Protocol
IP	Internet Protocol
IPTV	Internet Protocol Television
KA	KreaTV Americas
LAN	Local Area Network
LED	Light Emitting Diode
MAC	Media Access Control
MoCA	Multi-Media Over Coax Alliance
MP	MotoPLYR

MRL	Media Resource Locator
NTP	Network Time Protocol
ONT	Optical Network Terminator
OSD	Onscreen Diagnostics
OOB	Out of Band
PER	Packet Error Ratio
PFD	Protected Flash Data
QAM	Quadrature Amplitude Modulation
rDVR	Remote DVR
SMART	Self-Monitoring, Analysis, and Reporting Technology
STB	Set-top box
TR-069	Technical Report 069
UI	User Interface
URL	Uniform Resource Locator
USB	Universal Serial Bus
UTF	Unicode Transformation Format
VMS	Video Media Server
WAN	Wide Area Network
XML	Xtensible Markup Language



ARRIS Enterprises, Inc.
3871 Lakefield Drive, Suwanee, GA 30024
www.arrisi.com

365-095-25654 x.1 11/2013

