

# Wireless Broadband Router

**MI424WR**  
**rev. G**

## User Manual



# Contents

## FiOS Router User Manual

### 1

#### Introduction

- 1.0 Introduction
- 1.1 Package Contents
- 1.2 System Requirements
- 1.3 Features
- 1.4 Getting to Know the FiOS Router

### 2

#### Connecting the FiOS Router

- 2.0 Introduction
- 2.1 Setting Up the FiOS Router
- 2.2 Computer Network Configuration
- 2.3 Configuring the FiOS Router
- 2.4 Features
- 2.5 Main Screen

### 3

#### Setting Up a Wireless Network

- 3.0 Introduction
- 3.1 Overview
- 3.2 Connecting a Wireless Client
- 3.3 Wireless Status
- 3.4 Basic Security Settings
- 3.5 Advanced Security Settings
- 3.6 Setting Up a Wireless Client

### 4

#### Configuring My Network Settings

- 4.0 Introduction
- 4.1 Accessing My Network Settings
- 4.2 Using My Network Settings

# Contents

## FiOS Router User Manual (con't)

### 5

#### Using Network Connections

- 5.0 Introduction
- 5.1 Accessing Network Connections
- 5.2 Network (Home/Office) Connection
- 5.3 Ethernet Connection
- 5.4 Wireless Access Point Connection
- 5.5 Coax Connection
- 5.6 Broadband Ethernet Connection
- 5.7 Broadband Coax Connection
- 5.8 WAN PPPoE Connection
- 5.9 WAN PPPoE 2 Connection

### 6

#### Configuring Security Settings

- 6.0 Introduction
- 6.1 Overview
- 6.2 Firewall
- 6.3 Access Control
- 6.4 Port Forwarding
- 6.5 DMZ Host
- 6.6 Port Triggering
- 6.7 Remote Administration
- 6.8 Static NAT
- 6.9 Advanced Filtering
- 6.10 Security Log

### 7

#### Parental Controls

- 7.0 Introduction
- 7.1 Activating Parental Controls
- 7.2 Rule Summary

# Contents

## FiOS Router User Manual (con't)

### 8

#### **Configuring Advanced Settings**

- 8.0 Introduction
- 8.1 Using Advanced Settings
- 8.2 Utilities
- 8.3 DNS Settings
- 8.4 Network Settings
- 8.5 Configuration Settings
- 8.6 Time Settings
- 8.7 Firmware Upgrade
- 8.8 Routing Settings

### 9

#### **Monitoring the FiOS Router**

- 9.0 Introduction
- 9.1 Router Status
- 9.2 Advanced Status

### 10

#### **Troubleshooting**

- 10.0 Introduction
- 10.1 Troubleshooting Tips
- 10.2 Frequently Asked Questions

### A

#### **Configuring Quality of Service**

- A.0 Introduction
- A.1 Traffic Priority
- A.2 Traffic Shaping

# Contents

## FiOS Router User Manual (con't)

### B

#### Specifications

- B.0** Introduction
- B.1** General
- B.2** LED Indicators
- B.3** Environmental

### C

#### Notices

- C.0** Introduction
- C.1** Regulatory Compliance Notices
- C.2** Modifications
- C.3** NEBS Requirements
- C.4** GPL

# 1

- 1.0** Introduction
- 1.1** Package Contents
- 1.2** System Requirements
- 1.3** Features
- 1.4** Getting to Know the FiOS Router

# Introduction

**The Verizon FiOS® Router lets you transmit and distribute digital entertainment and information to multiple devices via coaxial cables. The FiOS Router also supports Ethernet and Wi-Fi networking, making it one of the most versatile and powerful routers available.**

# 1

## Introduction

### 1.1 Package Content

#### 1.1 Package Content

The following is a list of the items included with the FiOS Router:

- Black Power adapter
- Yellow cable (Ethernet, 6 ft.)
- White cable (Ethernet, 10 ft.)
- Quick Start Guide
- Installation Guide
- User Manual CD
- Wireless Networking Guide
- Wall-mount template
- Vertical stand

#### 1.2 Minimum System Requirements

The FiOS Router must be used with the following systems and software:

- Computer with Ethernet capability
- Microsoft Windows 2000, XP, Vista, or 7; Mac OS 10.1 or greater; Linux/BSD, Unix
- Internet Explorer 5.0 or higher; Netscape Navigator 7.0 or higher
- TCP/IP network protocol installed on each computer



## 1.3 Features

The FiOS Router features:

- Multiple networking standards support, including:
  - WAN - Ethernet and MoCA interfaces
  - LAN - 802.11b/g/n, Ethernet, and MoCA interfaces
- Integrated wired networking with 4-port 10/100/1000 Mbps Ethernet switch and MoCA
- Integrated wireless networking with 802.11b/g/n access point featuring:
  - 802.11n enabled to support speeds up to 160 Mbps wirelessly
  - 802.11g enabled to support speeds up to 54 Mbps wirelessly
  - 802.11b compatibility, communicating with 802.11b wireless products at speeds up to 11 Mbps
- Enterprise-level security, including:
  - Fully customizable firewall with Stateful Packet Inspection
  - Content filtering with URL-keyword based filtering, parental control, customizable filtering policies per computer, and E-mail notification
  - Denial of service protection against IP spoofing attacks, intrusion and scanning attacks, IP fragment overlap, ping of death, and fragmentation attacks
  - Event logging
  - Intrusion detection
  - MAC address filtering
  - NAT
  - DMZ hosting
  - Access control
  - Advanced wireless protection featuring WPA, WPA2, WEP 64/128 bit encryption, 802.1x authentication, and MAC address filtering
  - ICSA certification

# 1 Introduction

## 1.3 Features

- Other options, including:
  - DHCP server option
  - DHCP server/PPPoE server auto-detection
  - DNS server
  - LAN IP and WAN IP address selection
  - MAC address cloning
  - Port forwarding
  - PPPoE support
  - QoS support (end to end layer 2/3) featuring Diffserv, 802.1p/q prioritization, configurable upstream/downstream traffic shaping, random early detection and pass-through of WAN-side DSCPs, PHBs, and queuing to LAN-side devices
  - Remote management and secured remote management using HTTPS
  - Reverse NAT
  - Static NAT
  - Static routing
  - Time zone support
  - VLAN multicast support
  - VPN IPSec (VPN pass-through only)

## 1.4 Getting to Know the FiOS Router

This section contains a quick description of the FiOS Router's lights (LEDs), ports, etc. The FiOS Router has several indicator lights on its front panel, a sticker on its bottom panel, and a series of ports and switches on its rear panel.

### 1.4a Front Panel

The front panel of the FiOS Router has a series of indicator lights: Power, WAN Ethernet, WAN Coax, Internet, LAN Ethernet (4), LAN Coax, USB (2), and Wireless. It also features a WPS button.

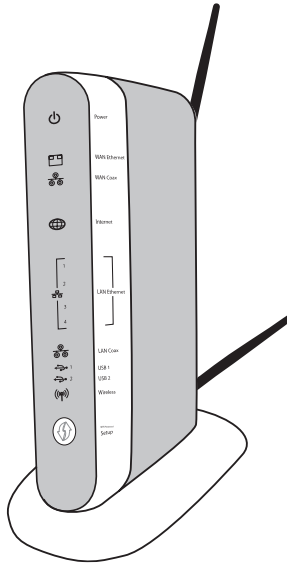

Front view – Verizon FiOS Router (rev. G)

# 1

## Introduction

### 1.4 Getting to Know the FiOS Router

#### Power

The Power LED displays the FiOS Router's current status. If the Power light glows steadily green, the FiOS Router is receiving power and fully operational. When the Power light flashes rapidly, the FiOS Router is initializing. If the Power light is not illuminated or glows red when the Power cord is plugged in and the Power switch is turned on, the FiOS Router has suffered a critical error and technical support should be contacted.

#### WAN Ethernet

The WAN Ethernet LED illuminates when the FiOS Router is connected to the Internet via Ethernet. If flashing, data traffic is passing across the port.

#### WAN Coax

The WAN Coax LED glows steadily or flashes when the FiOS Router is connected to the Internet via coaxial cable.

#### Internet

When the Internet LED glows steadily green, the FiOS Router is connected to the ISP (Internet Service Provider). If it glows amber, there is a physical connection to the ONT (Optical Network Terminator), but authentication has not taken place (i.e., no IP address is present).

#### LAN Ethernet (1, 2, 3, 4)

The LAN Ethernet LEDs illuminate when the FiOS Router is connected to a local network via one or more of its Ethernet ports. If flashing, data traffic is passing across the port(s).

#### LAN Coax

The LAN Coax LED glows steadily or flashes when the FiOS Router is connected to a local network via its Coax port.

**USB (1, 2)**

The USB LEDs illuminate when the FiOS Router is connected to a device via one of its USB ports.

**Wireless**

The Wireless LED illuminates when the FiOS Router’s wireless access point is turned on. If flashing, data traffic is passing across the wireless connection.

**Wi-Fi Protected Setup**

WiFi Protected Setup (WPS) is an easier way to set up a wireless network. Instead of entering passwords or multiple keys on each wireless client (laptop, printer, external hard drive, etc.), the FiOS Router can create a wireless network that only requires the pressing of buttons (one on the FiOS Router, and one on the client [either built-in, or on a compatible wireless card]) to allow wireless clients to join the FiOS Router’s wireless network. Although the WPS button is included on the FiOS Router, WPS functionality will not be enabled until a future firmware release. The button is included so that WPS can be activated at a later date without having to physically change the FiOS Router. The GUI does not include the WPS option.

**1.4b Bottom Panel**

The bottom panel of the FiOS Router has a sticker that contains important information about the FiOS Router, including default ESSID, MAC address, wireless keys, etc.



**Bottom panel sticker – Verizon FiOS Router (rev. G)**

# 1

## Introduction

### 1.4 Getting to Know the FiOS Router

#### 1.4c Rear Panel

The rear panel of the FiOS Router has eight ports (Coax, Power, LAN Ethernet [4], WAN Ethernet, and USB), a Power switch, a Reset button, and a wireless antenna.

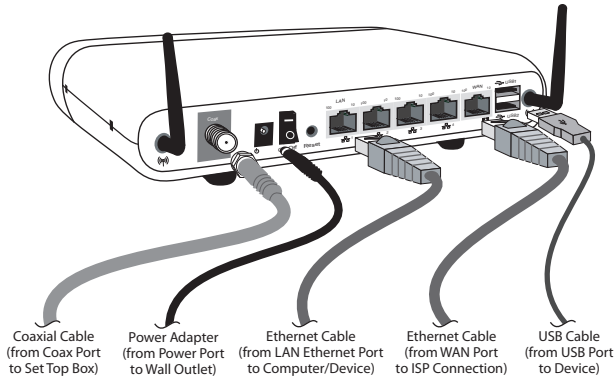

Rear view – Verizon FiOS Router (rev. G)

#### Coax Port

The Coax port connects the FiOS Router to the ISP or other devices using a coaxial cable.

#### Power Port

The Power port connects the FiOS Router to an electrical wall outlet via the Power cord.

#### Power Switch

The Power switch powers the FiOS Router on and off.

## Reset Button

To restore the FiOS Router's factory default settings, press and hold the Reset button for approximately ten seconds. The reset process will start about ten seconds after releasing the button. When the FiOS Router resets, all the lights on the front panel turn off, and then some of the lights start flashing. The FiOS Router has completed its reset process when the Power light glows steadily green.

**Caution!** Do not unplug the Power cord from the FiOS Router during the reset process. Doing so may result in the loss of the FiOS Router's configuration information. If this occurs, reset the FiOS Router again.

## LAN Ethernet Ports (4)

The LAN Ethernet ports connect devices to the FiOS Router via Ethernet cables to create a local area network (LAN). The LAN Ethernet ports are 10/100/1000 Mbps auto-sensing ports, and either a straight-through or crossover Ethernet cable can be used when connecting devices to the ports.

## WAN Ethernet Port

The WAN Ethernet port connects the FiOS Router to the ISP using an Ethernet cable.

## USB Ports

The USB ports provide up to 5 VDC for attached devices (to charge a cell phone, for example). In the future, with a firmware release upgrade, the USB host functionality will be available for devices such as external storage and cameras.

## Wireless Antenna

The FiOS Router's wireless antenna is used to transmit a wireless signal to other wireless devices on its wireless network.

# 2

- 2.0** Introduction
- 2.1** Setting up the FiOS Router
- 2.2** Computer Network Configuration
- 2.3** Configuring the FiOS Router
- 2.4** Main Screen

# Connecting the FiOS Router



Connecting the FiOS Router and accessing its Graphical User Interface (GUI) are both simple procedures. The latter procedure may vary slightly, depending on the computer's operating system. However, no configuration is necessary to access the GUI when taking advantage of Universal Plug-and-Play support.

## 2.1 Setting Up the FiOS Router

There are three parts to setting up the FiOS Router: **Connecting the Cables**, **Configuring the Router**, and **Connecting Other Computers/Set Top Boxes**.

### 2.1a Connecting the Cables

**Note:** If a different router was being used previously, disconnect it. Remove all router components, including power supplies and cables, as they will not work with the FiOS Router.

1. Get the FiOS Router and black Power cord from the box.
2. Plug the black Power cord in the black port on the back of the FiOS Router and then into a power outlet.
3. Turn the FiOS Router on.
4. Make sure the Power light on the front of the FiOS Router glows steadily green.
5. Plug the yellow Ethernet cable from the box into one of the four yellow Ethernet ports on the back of the FiOS Router.
6. Make sure the computer is powered on, then plug the other end of the yellow Ethernet cable into an Ethernet port on the computer.
7. Make sure at least one of the Ethernet LAN lights on the front of the FiOS Router glows steadily green. This may take a few moments.
8. The phone company previously installed a high-speed wall jack somewhere in the house. Locate it and note its type (Ethernet or coaxial). If Ethernet, follow steps 8a and 8b. If coaxial, follow steps 9a and 9b. Then, continue to step 10.
  - a. If connecting via Ethernet, get the white Ethernet cable from the box and plug one end in the white port on the back of the FiOS Router.
  - b. Plug the other end of the white Ethernet cable into the high-speed Ethernet jack.

9.
  - a. If connecting via coaxial cable, get a coaxial cable and connect one end to the red Coax port on the back of the FiOS Router.
  - b. Connect the other end of the coaxial cable to a coax jack.
10. Make sure the Ethernet WAN light (if connecting via Ethernet) or Coax WAN light (if connecting via coaxial cable) on the front of the FiOS Router glows steadily green. If connecting via coaxial cable, this may take a few minutes.

**Note:** If the Ethernet WAN light or Coax WAN light does not illuminate, make sure the cable (Ethernet or coaxial) is connected properly at both ends.

## 2.2 Computer Network Configuration

Each network interface on the computer should either be configured with a statically defined IP address and DNS address, or instructed to automatically obtain an IP address using the Network DHCP server. The FiOS Router is set up, by default, with an active DHCP server, and we recommend leaving this setting as is.

### 2.2a Configuring Dynamic IP Addressing

To set up a computer to use dynamic IP addressing:

#### Windows 7

1. In the Control Panel, select **View Network Status and Tasks** (below "Network and Internet").
2. Under "Connect or disconnect," click **Local Access Connection**.
3. The "Local Area Connection Status" window appears. Click **Properties**.
4. The "Local Area Connection Properties" window appears. Select **Internet Protocol Version 4 (TCP/IPv4)**, then click **Properties**.
5. The "Internet Protocol Version 4 (TCP/IPv4) Properties" window appears.
6. Click the "Obtain an IP address automatically" radio button.
7. Click the "Obtain DNS server address automatically" radio button.
8. Click **OK** in the Internet Protocol Version 4(TCP/IPv4) Properties window, then click **OK** in the Local Area Connection Properties screen to save the settings.

## 2 Connecting the FiOS Router

### 2.2 Computer Network Configuration

#### Windows Vista

1. Select **Network and Sharing** in the Control Panel.
2. Click **View Status**, then click **Properties**.
3. Click **Continue** in the “User Account Control” window.
4. In the “General” tab of the “Local Area Connection Properties” window select **Internet Protocol Version 4 (TCP/IPv4)**, then click **Properties**.
5. The “Internet Protocol Version 4 (TCP/IPv4) Properties” window appears.
6. Click the “Obtain an IP address automatically” radio button.
7. Click the “Obtain DNS server address automatically” radio button.
8. Click **OK** in the Internet Protocol Version 4(TCP/IPv4) Properties window, then click **OK** in the “Local Area Connection Properties” screen to save the settings.

#### Windows XP

1. Select **Network Connections** in the Control Panel.
2. Right-click **Ethernet Local Area Connection**, then click **Properties**.
3. In the “General” tab, select **Internet Protocol (TCP/IP)**, then click **Properties**.
4. The “Internet Protocol (TCP/IP) Properties” window appears.
5. Click the “Obtain an IP address automatically” radio button.
6. Click the “Obtain DNS server address automatically” radio button.
7. Click **OK** in the “Internet Protocol (TCP/IP) Properties” screen, then click **OK** in the “Local Area Connection Properties” screen to save the settings.

## Windows 2000

1. Select **Network and Dialing Connections** in the Control Panel.
2. Right-click on the Ethernet connection's icon, then click **Properties**.
3. Select **Internet Protocol (TCP/IP)** component, then click Properties.
4. The "Internet Protocol (TCP/IP) Properties" window appears.
5. Click the "Obtain an IP address automatically" radio button.
6. Click the "Obtain DNS server address automatically" radio button.

## Macintosh OS X

1. Click on the Apple icon in the top left corner of the desktop.
2. From the menu that appears, select **System Preferences**.
3. The "System Preferences" window appears. Click **Network**.
4. From the "Network" window, make sure "Ethernet" in the list on the left is highlighted and displays "Connected."
5. Click **Assist me**.
6. From the tab that appears, click **Diagnostics**.
7. Follow the instructions in the "Network Diagnostics" assistant.

## Linux

1. Login into the system as a super-user by entering "su" at the prompt.
2. Type "ifconfig" to display the network devices and allocated IPs.
3. Type "pump -i <dev>," where <dev> is the network device name.
4. Type "ifconfig" again to view the newly allocated IP address.
5. Make sure no firewall is active on device <dev>.

## 2 Connecting the FiOS Router

### 2.3 Configuring the FiOS Router

### 2.3 Configuring the FiOS Router

1. Open a web browser on the computer connected to the FiOS Router. In the “Address” text box, type:

**http://192.168.1.1**

then press **Enter** on the keyboard.

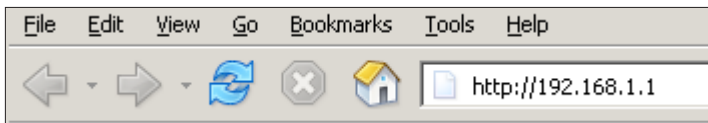

2. The “Login Setup” screen appears. Select a new user name and password and enter them in the appropriate text boxes (the password must be entered twice, for validation purposes). Write the new user name and password down on a piece of paper and keep it in a safe place, since they will be needed to access the FiOS Router’s GUI (Graphical User Interface) in the future.

**Login Setup**

**Step 1.**  
We now require you to change your default login User Name and Password. Please select a new login User Name and Password and type it into the appropriate fields below.

**NOTE:** The password must be at least 6 characters long and include at least one alpha numeric character. The password cannot begin with characters such as "?!@#%&\*".

<b>New User Name:</b>	<input type="text" value="admin"/>
<b>New Password:</b>	<input type="password"/>
<b>Retype New Password:</b>	<input type="password"/>

**Step 2.**  
Please select your appropriate Time Zone and click **OK**.

<b>Local Time:</b>	Aug 4, 2006 19:25:52
<b>Time Zone:</b>	<input type="text" value="Eastern_Time (GMT-05:00)"/> ▼

3. In the bottom part of the screen, select the correct time zone from the “Time Zone” drop-down list, then click **OK** at the bottom of the screen.

The FiOS Router is now configured.

### 2.3a Connecting Other Computers/Set Top Boxes

The FiOS Router can connect to other computers or set top boxes in three ways: via Ethernet, via wireless connection, or via coaxial cable.

#### Ethernet

1. Get an Ethernet cable and plug one end into one of the open yellow Ethernet ports on the back of the FiOS Router.
2. Plug the other end of the Ethernet cable into an Ethernet port on the computer.
3. Make sure the corresponding Ethernet LAN light on the front of the FiOS Router glows steadily green.
4. Repeat these steps for each computer to be connected to the FiOS Router via Ethernet.

#### Wireless

1. Make sure each computer to be connected wirelessly has built-in wireless or an attached wireless adapter.
2. Make sure the computer uses the same ESSID and WPA key as the FiOS Router by launching the computer's wireless application
3. Enter the ESSID and WPA key found on the sticker on the bottom of the FiOS Router in the computer's wireless settings and click **Save**.
4. Make sure the changes were implemented by surfing the Internet from the computer.
5. Repeat these steps for every other computer to be connected to the FiOS Router wirelessly.

## 2 Connecting the FiOS Router

### 2.4 Main Screen

#### Coaxial

1. Make sure all set top boxes are turned off.
2. Disconnect any adapter currently connected to the coaxial jack in the room where the FiOS Router is.
3. Connect one end of the coaxial cable to the coaxial wall jack, and the other end to the red Coax port on the back of the FiOS Router.
4. Power up the set top box.
5. Make sure the Coax LAN light on the front of the FiOS Router glows steadily green. This may take a few minutes. When it does, the set top box is connected to the FiOS Router.

## 2.4 Main Screen

After logging into the FiOS Router's GUI (see "Configuring the FiOS Router" at the beginning of this chapter), the "Main" screen appears.

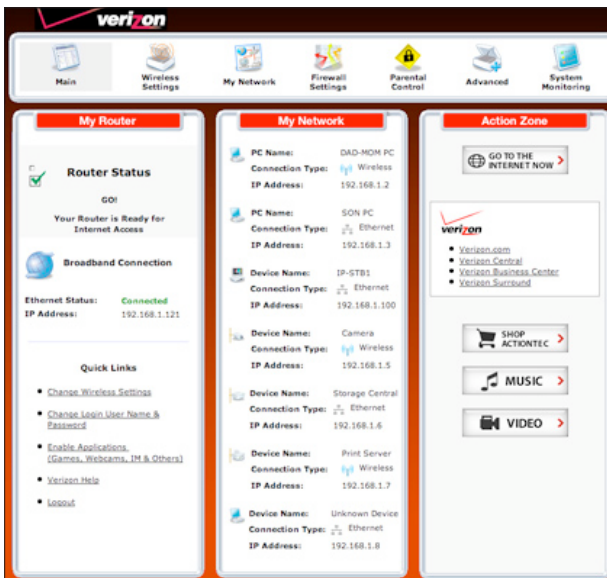



The Main screen has a menu occupying the top of the screen. Below that, the screen is divided into three columns: "My Router," "My Network," and "Action Zone."

## 2.4a Menu

The Main screen's menu contains links to all of the configuration options of the FiOS Router: **Wireless Settings** (explained in chapter 3 of this manual), **My Network** (chapter 5), **Firewall Settings** (chapter 6), **Parental Controls** (chapter 7), **Advanced** (chapter 8), and **System Monitoring** (chapter 9).

## 2.4b My Router

This section displays the status of the FiOS Router's network and Internet connection. A green light signifies the FiOS Router is connected; a yellow light means the FiOS Router is attempting to connect; and a red light signifies the FiOS Router's connection is down.

### Broadband Connection

The "Broadband Connection" section of the My Router column displays the state of the FiOS Router's broadband connection ("Connected" or "Disconnected") for the two connection options ("Coax Status" and "Ethernet Status"), and the WAN IP address of the broadband connection.

### Quick Links

The "Quick Links" section of the My Router column contains a list of frequently accessed settings, including "Change Wireless Settings," "Change Login User Name & Password," "Enable Gaming," and "Logout."

## **2** Connecting the FiOS Router

### 2.4 Main Screen

#### **2.4c My Network**

The “My Network” column of the Main screen displays the connection type, name, and IP address of all devices connected to the FiOS Router’s network. The icon associated with the device will be displayed normally (signifying an active device) or shaded (signifying the device has not been active for at least 60 seconds). The user can also configure the basic settings of each device by clicking on its icon. These settings are described in more detail in chapter 3.

#### **2.4d Action Zone**

This column contains links to various Verizon Web sites, and other informational links. Clicking on the icon above “Go to Internet Now” connects the user to the home page configured on the user’s web browser.

# 3

- 3.0** Introduction
- 3.1** Overview
- 3.2** Connecting a Wireless Client
- 3.3** Wireless Status
- 3.4** Basic Security Settings
- 3.5** Advanced Security Settings
- 3.6** Setting Up a Wireless Client

# Setting Up a Wireless Network

**Wireless networking enables you to free yourself from wires and plugs, making your devices more accessible and easier to use. This chapter explains how to create a wireless network using the FiOS Router, including accessing and configuring wireless security options.**

## 3.1 Overview

The FiOS Router provides the user with wireless connectivity over the 802.11b, g, and n standards (the most common wireless standards). 802.11b has a maximum data rate of 11 Mbps, 802.11g has a maximum data rate of 54 Mbps, and 802.11n has a maximum data rate of 160 Mbps. All standards operate in the 2.4 GHz range.

The FiOS Router's wireless feature is turned on, with wireless security activated, by default. The level of security is WPA2, with a unique WPA2 key already entered. This information is displayed on a sticker located on the bottom of the FiOS Router.

The FiOS Router integrates multiple layers of security. These include the IEEE 802.1x port-based authentication protocol, RADIUS client, EAP-MD5, EAP-TLS, EAP-TTLS, EAP-PEAP, Wired Equivalent Privacy (WEP), Wi-Fi Protected Access (WPA and WPA2) and firewall and VPN applications.

## 3.2 Connecting a Wireless Client

To connect a wireless client to the FiOS Router:

**Note:** The following procedure assumes the FiOS Router's default wireless settings are intact. If they have been changed, use the new ESSID and wireless security settings. For more details, see the "Setting Up a Wireless Client" section of this chapter.

1. In the wireless client's configuration interface, enter the FiOS Router's ESSID (found on a sticker on the bottom of the FiOS Router's case) in the appropriate text box or field (this varies depending on the wireless client's manufacturer).
2. Enter the FiOS Router's wireless key (also found on the sticker on the bottom of the FiOS Router's case) in the wireless client's configuration interface.
3. Save the changes and exit the wireless client's configuration interface. The client should now detect and join the FiOS Router's wireless network. If not, check the wireless client's documentation, or contact its manufacturer.

### 3.3 Wireless Status

Clicking on the “Wireless Settings” icon from the Main screen’s menu generates the “Wireless Status” screen, which displays the current status of the wireless connection.

Wireless Status	
Radio Enabled:	Yes
SSID:	XFAZ4
Channel:	Automatic
Security Enabled:	Yes
WEP 64-bit:	N/A
WEP 802.1x:	N/A
WPA2:	c475b6d8bdf49b0f64de8102a
SSID Broadcast:	Enabled
MAC Authentication:	Disabled
Wireless Mode:	Compatibility Mode(802.11b/g/n)
WMM:	Enabled
Received Packets:	0
Sent Packets:	109

#### 3.3a Radio Enabled

Displays whether the FiOS Router’s wireless radio is active.

#### 3.3b SSID

The SSID (Service Set Identifier) is the network name shared among all devices on a particular wireless network. The SSID must be identical for all devices on the wireless network. It is case-sensitive and cannot exceed 32 characters. Make sure the SSID is the same for all devices to be connected to the wireless network. The FiOS Router comes from the factory with an SSID already entered and displayed here. The default SSID can also be found on a sticker on the bottom of the FiOS Router.

#### 3.3c Channel

Displays the channel to which the wireless connection is currently set. All devices on the wireless network must be on the same channel to function correctly.

### 3.3d Security Enabled

Displays what kind of security is active on the wireless connection, and the security encryption key.

### 3.3e SSID Broadcast

Displays whether the FiOS Router is broadcasting its SSID. If activated, the SSID of the FiOS Router's wireless network is broadcast wirelessly.

### 3.3f MAC Authentication

Displays whether the FiOS Router is using MAC (Media Access Control) address authentication to allow wireless devices to join the network.

### 3.3g Wireless Mode

Displays the types of wireless device that can join the network. Options include 802.11b, 802.11g, 802.11 n, or Mixed (allows 802.11b-, 802.11g-, and 802.11n-equipped wireless devices to join the network).

### 3.3h WMM

Displays whether WMM is enabled on the FiOS Router.

### 3.3i Packets Received/Sent

Displays the number of packets received and sent since the FiOS Router's wireless capability was activated.

# 3 Setting Up a Wireless Network

## 3.4 Basic Security Settings

### 3.4 Basic Security Settings

To configure the FiOS Router's wireless network for basic security, select "Basic Security Settings" from the menu on the left side of any Wireless Settings screen. The "Basic Security Settings" screen appears.

**Note:** The FiOS Router's default wireless security is WPA2. This section explains how to activate WEP wireless security, which is a less robust security than WPA2. To set up WPA2 wireless security, see "WPA2" on page 37.

#### Basic Security Settings

Instructions for setting up a wireless network using basic WEP wireless security are set out below. However, we recommend that you establish stronger security using the Advanced Security Settings. To establish stronger security, select "OFF" in Step 4, click on APPLY and then go to Advanced Security Settings to setup security.

**1. Turn Wireless ON**

Wireless:  On  Off

**2. Change the SSID setting to any name or code you want**  
(SSID is the same thing as the name of your Wireless Network.)

SSID:

**3. Channel**

To change the channel of the frequency band at which the Router communicates, please enter it below. Then click apply to save your settings:

**NOTE:** In the United States, use channels 1-11.

Channel:

Keep my channel selection during power cycle.

**4. Click on the button next to WEP**

WEP prevents unintentional connections to your wireless home network. For greater protection against hacking and security breaches, see Advanced Security Settings.

WEP  Off

1. Click the "On" radio button to activate the FiOS Router's wireless radio.
2. Enter the name of the wireless network in the "SSID" text box (the SSID name in the figure above is an example; enter a different name for the SSID).
3. Select the channel at which the FiOS Router's wireless radio communicates by selecting it from the "Channel" drop-down list.
4. To preserve the channel selection in the event of a FiOS Router power cycle, click in the box next to "Keep my channel selection during power cycle."



5. Click the “WEP” radio button to activate WEP (Wired Equivalent Privacy) security on the wireless network.
6. Select a WEP security level from the “select a WEP Key” drop-down list (options include “64/40 bit” or “128/104 bit”).
7. Enter the key code in the “Key Code” text box. Each character must be a letter from A-F or a number from 0-9. If 64/40 bit was selected in step 5, enter 10 characters. If 128/104 was selected, enter 26 characters.
8. Write down the wireless settings displayed on the screen. Other wireless devices must use these same settings when configuring the device’s wireless networking scheme to join the FiOS Router’s wireless network.
9. Click **Apply** to save the settings.

**5. Select a WEP Key**

**NOTE:** - To create a 64/40 WEP Hex Key, you need to enter a combination of 10 digits. You can choose any letter from A-F or any number from 0-9. Sample HEX WEP Key: 0FB310FF28.  
 - To create a 64/40 WEP ASCII, you need to enter a combination of 5 ASCII characters. Sample ASCII WEP Key: hello.

**Select a WEP Key:** 64/40 bit Hex

**Key Code:** C475B6D8BD **0 Digits left**

**6. Write down wireless settings.**

In order for every computer to connect to this Router wirelessly, you need to make sure that the wireless setup for each computer uses the SAME settings listed below. Please make sure that you write down all of the values set on this screen.

**Current Wireless Status:**

Wireless:	<b>ON</b>
SSID:	XFAZ4
64-BIT WEP:	<b>OFF</b>
64-BIT WEP KEY:	C475B6D8BD
Channel:	Automatic
SSID Broadcast:	<b>Enabled</b>
MAC Authentication:	<b>Disabled</b>
Wireless Mode:	Compatibility Mode(802.11b/g/n)
Packets Sent:	110
Packets Received:	0

Apply

### 3.5 Advanced Security Settings

To configure the FiOS Router's advanced wireless network security settings, select "Advanced Security Settings" from the menu on the left side of any Wireless Settings screen. The "Advanced Security Settings" screen appears.

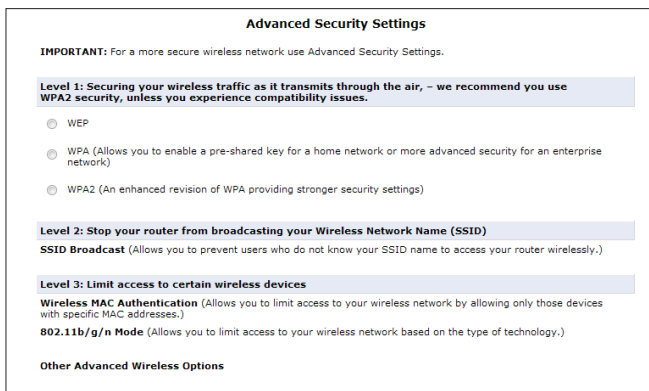

#### 3.5a Level 1 (Wireless Security)

This section is used to configure different types of wireless security. Select the type of wireless security to be applied to the wireless network by clicking the appropriate radio button, then configure the security settings in the subsequent screens.

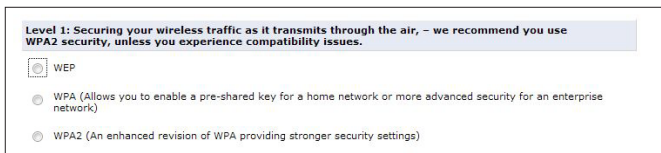

## WEP

If WEP was selected in the Advanced Security Settings screen, the “WEP” screen appears.

**WEP**

**WEP Mode:** WEP Only ▾

**Network Authentication:** Open System Authentication ▾

WEP Keys			
Active	Encryption Key	Entry Method	Key Length
<input checked="" type="radio"/> 1	C005675C1F	Hex ▾	64/40 bit ▾
<input type="radio"/> 2		Hex ▾	64/40 bit ▾
<input type="radio"/> 3		Hex ▾	64/40 bit ▾
<input type="radio"/> 4		Hex ▾	64/40 bit ▾

1. Select the appropriate WEP mode from the drop-down list. Options include WEP Only, or 802.1x. If selecting the latter, see the “802.1x” section on the next page.
2. Select the appropriate network authentication level from the drop-down list. Options include Open System Authentication, Shared Key Authentication, or Both.
3. Activate WEP key 1 by clicking the radio button next to “1” on the left side.
4. Select the length of key 1 by selecting “64/40 bit” or “128/104 bit” from the appropriate drop-down list in the “Key Length” column.
5. Select the type of key from the appropriate drop-down list in the “Entry Method” column. If “Hex” is selected, the key must be made up of hexadecimal digits. If “ASCII” is selected, the key can be made up of any characters.
6. Enter the key in the appropriate text box in the “Encryption Key” column. If 64/40 bit was chosen in step 2, enter 10 characters. If 128/104 bit was chosen, enter 24 characters. Depending on what option was selected in step 3, enter hexadecimal or ASCII characters.
7. Click **Apply** to save changes.

### 802.1x

If 802.1x was selected in step 1 of the previous procedure, another screen appears, relating to settings for 802.1x WEP.



The screenshot shows a configuration window titled "WEP+802.1x Radius Settings". It contains three input fields: "Server IP:" with a dotted IP address format (ip .0 .0 .0), "Server Port:" with the value "1812", and "Shared Secret:" with an empty text box. At the bottom of the window are two buttons: "Back" and "Apply".

802.1x WEP is a robust security protocol that uses port control with dynamically changing encryption keys automatically updated over the network. 802.1x WEP uses a RADIUS (Remote Authentication Dial-in Service) server for authentication purposes. This server must be physically connected to the FiOS Router. Also, the user must enable the RADIUS client embedded in the FiOS Router (to do this, see chapter 8, "Advanced Settings").

1. Enter the RADIUS server IP address in the "Server IP" text boxes.
2. Enter the RADIUS server's port number in the "Server Port" text box.
3. Enter the RADIUS server's shared secret in the "Shared Secret" text box.
4. Click **Apply** to save changes.

## WPA

If WPA (Wi-Fi Protected Access) was selected, the “WPA Key” screen appears.

1. Verify the authentication method selected is “Pre-Shared Key.”
2. Enter a phrase of at least eight characters in the “Pre-Shared Key” text box. Verify that “ASCII” is selected in the associated drop-down list.
3. Select the proper encryption algorithm (TKIP, AES, or TKIP+AES).
4. Click in the “Group Key Update Interval” check box to activate the group key update interval, and set the interval time in the text box to the right.
5. Click **Apply** at the bottom of the screen to save changes.

## WPA2

If WPA2 was selected, the “WPA2” screen appears.

1. Verify the authentication method selected is “Pre-Shared Key.”
2. Enter a phrase of at least eight characters in the “Pre-Shared Key” text box. Verify that “ASCII” is selected in the associated drop-down list.

## 3 Setting Up a Wireless Network

### 3.5 Advanced Security Settings

3. Select the proper encryption algorithm (TKIP, AES, or TKIP+AES).
4. Click in the “Group Key Update Interval” check box to activate the group key update interval, and set the interval time in the text box to the right.
5. Click **Apply** at the bottom of the screen to save changes.

#### 3.5b Level 2 (SSID Broadcast)

This section is used to configure the FiOS Router’s SSID broadcast capabilities. Enabling this option allows any wireless device using an SSID of “Any” to detect the FiOS Router’s wireless network. Disabling “SSID Broadcast” allows only those wireless users who know the SSID of the wireless network to detect and connect to the network.

**Level 2: Stop your router from broadcasting your Wireless Network Name (SSID)**  
SSID Broadcast (Allows you to prevent users who do not know your SSID name to access your router wirelessly.)

Selecting “SSID Broadcast” generates the “SSID Broadcast” screen.

**SSID Broadcast**

When SSID Broadcast is enabled, it means that any computer or wireless device using the SSID of "Any" can see your Router. To prevent this from happening, disable the SSID broadcast so that only those Wireless devices with your SSID can access your Router.

Enable    Disable

[Back](#)   [Apply](#)

Click the “Enable” radio button to enable SSID broadcasting. If enabled, the SSID of the FiOS Router’s wireless network will be broadcast wirelessly. To disable SSID broadcasting, click the “Disable” radio button.



## 3 Setting Up a Wireless Network

### 3.5 Advanced Security Settings

To set up wireless MAC authentication:

1. Click in the “Enable Access List” check box.
2. Select either “Accept all devices listed below” or “Deny all devices listed below” by clicking the appropriate radio button. Selecting “Accept...” causes all devices listed by MAC address to access the FiOS Router’s wireless network. Selecting “Deny...” causes all listed devices to be denied access.
3. Enter the MAC address of a device in the “Client MAC address” text box.
4. Click **Add**.
5. Repeat steps 3 and 4 to add more devices to the list.
6. When finished listing devices, click **Apply**.

To remove a MAC address, select it from the “List” list box, then click **Remove**.

#### 802.11b/g/n Mode

This option allows the user to select the wireless communication standard compatible with the devices to be connected on the wireless network from the drop-down list. Options include Compatibility (802.11b, g, and n devices can connect) Legacy (only 802.11b and g devices can connect), and Performance (only 802.11n devices can join).

**802.11 Mode**

Access to the Router’s network can be restricted to wireless devices using either 802.11b/g (11Mbps/54Mbps) or 802.11n (130 Mbps) wireless devices. Select the option that best applies to your wireless network. Then click Apply button to save your settings.

**NOTE:**  
‘Compatibility Mode’ to support 802.11bg & 802.11n.  
‘Legacy Mode’ to support only 802.11bg.

802.11 Mode:  ▼



### 3.5d Other Advanced Wireless Options

Clicking **Other Advanced Wireless Options** at the bottom of the Advanced Security Settings screen generates (after clicking through the “Warning” screen) another “Advanced Wireless Options” screen.

Advanced Wireless Options	
Transmission Rate:	Auto
Transmit Power:	100 %
CTS Protection Mode:	None
CTS Protection Type:	cts-only
Frame Burst - Max Number:	3
Frame Burst - Burst Time:	2
Beacon Interval:	100 ms
DTIM Interval:	1 ms
Fragmentation Threshold:	2348
RTS Threshold:	2348
MSDU Aggregation:	<input type="radio"/> Enable <input checked="" type="radio"/> Disable
MPPDU Aggregation:	<input checked="" type="radio"/> Enable <input type="radio"/> Disable
802.11n Guard Interval:	Dynamic
<a href="#">WMM Settings</a>	
<input type="button" value="Back"/> <input type="button" value="Apply"/>	

#### Transmission Rate

Always set to “Auto.”

#### Transmit Power

Adjust the power of the FiOS Router’s wireless signal by entering a percentage in this text box.

#### CTS Protection Mode

Activating CTS (Clear to Send) Protection Mode allows mixed 802.11b/g/n networks to operate at maximum efficiency. Select **Auto** from the drop-down list to activate. Select **None** to deactivate .

#### CTS Protection Type

Select from the two options: **cts-only** (for mixed 802.11b/g/n networks) or **rts-cts**. (for 802.11a/b/g networks).

## **3** Setting Up a Wireless Network

### 3.5 Advanced Security Settings

#### Frame Burst - Max Number

Frame Burst allows packet bursting, which increases overall network speed. Enter the maximum number of frame bursts in this text box.

#### Frame Burst - Burst Time

Enter the burst time of the frame bursts in this text box.

#### Beacon Interval

Enter the time period of the beacon interval in this text box.

#### DTIM Interval

Enter the DTIM (Delivery Traffic Indication Message) interval value (in milliseconds) in this text box. A DTIM is a countdown mechanism for the FiOS Router, informing wireless network clients of the next window for listening to broadcast and multicast messages.

#### Fragmentation Threshold

Setting the correct fragmentation threshold can increase the reliability of frame transmissions on the wireless network. Enter the fragmentation threshold in this text box.

#### RTS Threshold

Enter the RTS (Request to Send) threshold in this text box. This setting controls what size data packet the low level RF protocol issues to an RTS packet.

#### MSDU Aggregation

Use these radio buttons to enable or disable MSDU aggregation.

### MPDU Aggregation

Use these radio buttons to enable or disable MPDU aggregation.

### 802.11 Guard Interval

Always set to “Dynamic.”

### 3.5e WMM Settings

Clicking **WMM Settings** at the bottom of the Advanced Wireless Options screen generates (after clicking through the “Warning” screen) the “Wireless QoS (WMM)” screen. This screen allows the user to prioritize the types of data coming over the FiOS Router’s wireless network.

**Wireless QoS (WMM)**

<b>Wireless QoS (WMM):</b>		<input checked="" type="checkbox"/> Enabled	
<b>WMM Power Save:</b>		<input checked="" type="checkbox"/> Enabled	

ID	Tag	Priority	Action
0	DSCP Best Effort - 0x00	WMM AC Best Effort - 0	
1	DSCP Background - 0x08	WMM AC Background - 1	
2	DSCP Excellent Effort - 0x18	WMM AC Best Effort - 0	
3	DSCP Video - 0x28	WMM AC Video - 2	
4	DSCP Audio - 0x38	WMM AC Voice - 3	
<b>Add</b>			

Priority	Admission Control Mandatory	Quota
WMM AC Voice - 3	No <input type="checkbox"/>	0 <input type="text"/>
WMM AC Video - 2	No <input type="checkbox"/>	0 <input type="text"/>
WMM AC Best Effort - 0	No <input type="checkbox"/>	0 <input type="text"/>

### Wireless QoS (WMM)

Click in the check box to enable/disable Wireless QoS.

### WMM Power Save

Click in the check box to enable/disable WMM Power Save.

# 3 Setting Up a Wireless Network

## 3.5 Advanced Security Settings

### Priority Table

The upper table in the Wireless QoS screen is the Priority Table.

ID	Tag	Priority	Action
0	DSCP Best Effort - 0x00	WMM AC Best Effort - 0	
1	DSCP Background - 0x08	WMM AC Background - 1	
2	DSCP Excellent Effort - 0x18	WMM AC Best Effort - 0	
3	DSCP Video - 0x28	WMM AC Video - 2	
4	DSCP Audio - 0x38	WMM AC Voice - 3	
<b>Add</b>			

Use the green up and down arrows to adjust the priority of a particular type of wireless data. The data type at the top of the table has the highest priority on the wireless network; at the bottom is the lowest. Additionally, the user can add a custom type of data by clicking **Add** and, in the screen that appears, creating a new type of data tag. Finally, clicking the Action icon in the row corresponding to an existing type of data allows the user to modify that type of data's Tag and WMM access.

### Admission Control Table

The lower table in the Wireless QoS screen is the Admission Control Table.

Priority	Admission Control Mandatory	Quota
WMM AC Voice - 3	No	0
WMM AC Video - 2	No	0
WMM AC Best Effort - 0	No	0

This table allows the user to adjust a wireless data type's admission control by selecting Yes/No from the corresponding row's drop-down list. Also, if needed, enter a Quota amount in the appropriate Quota text box.

## 3.6 Setting Up a Wireless Client

If the computer has wireless capabilities and is running Windows XP, Vista, or 7, it will automatically recognize the existing wireless network and try to create a wireless connection. View this connection under Windows' "Network Connections."

### 3.6a Setting Up a Wireless Windows Client (Windows 7)

If the computer has wireless capabilities and is running Windows 7, it will automatically recognize the existing wireless network and try to create a wireless connection. To manually connect to a wireless network:

1. Click the wireless icon the system tray (in the lower right corner of the desktop) and, from the menu that appears, click the FiOS Router's wireless network name from the list.

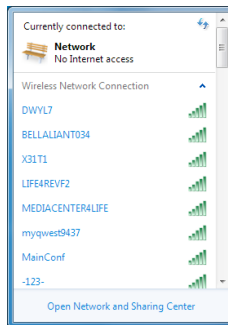

# 3 Setting Up a Wireless Network

## 3.6 Setting Up a Wireless Client

2. When the “Connect” button appears under the network’s name, click on it.

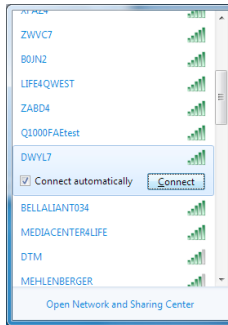

3. A “Connect to a Network” window appears. Enter the security key of the wireless network in the appropriate text box, then click OK.

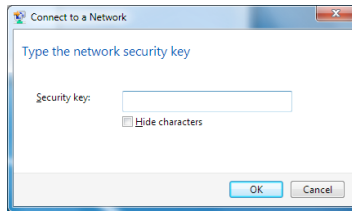

- The connection is made. To check the status of the connection, click on the wireless icon in the service tray again. In the example, the computer has successfully joined the wireless network "DWYL7."

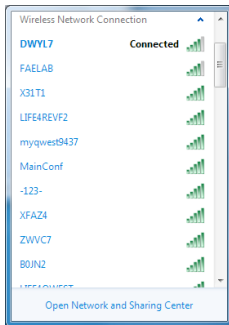

### 3.6b Setting Up a Wireless Windows Client (Windows Vista)

If the computer has wireless capabilities and is running Windows Vista, it will automatically recognize the existing wireless network and try to create a wireless connection. View this connection under Windows "Network Connections."

- Click the wireless icon the system tray (in the lower right corner of the desktop) and, from the menu that appears, select **Connect to a Network**.
- A "Connect to a Network" window appears. Select the FiOS Router's wireless network.

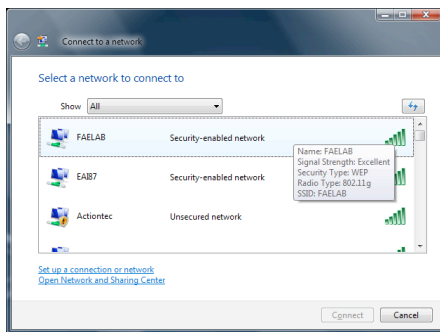

# 3 Setting Up a Wireless Network

## 3.6 Setting Up a Wireless Client

3. Another Connect to a Network window appears. Enter the WPA key of the network in the appropriate text box.

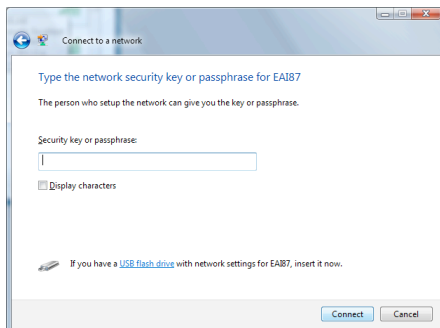

4. Click **Connect**. A third Connect to a Network window appears, stating that the connection was successful.

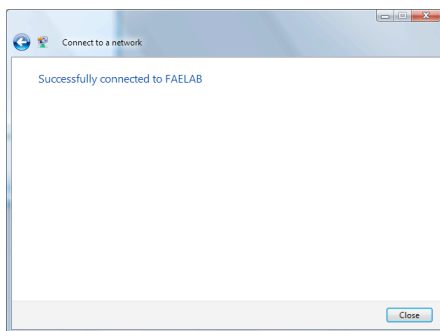



### 3.6c Setting Up a Wireless Windows Client (Windows XP)

This section assumes the FiOS Router's wireless network is set up with WPA security.

1. Click **Network Connections** in the Control Panel. The "Network Connections" window appears.

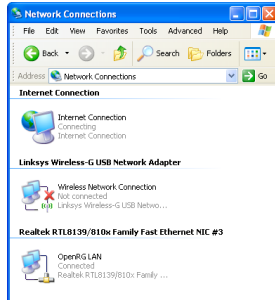

2. Double-click the wireless connection icon. The "Wireless Network Connection" screen appears, displaying the available wireless connections. Select the FiOS Router's network.

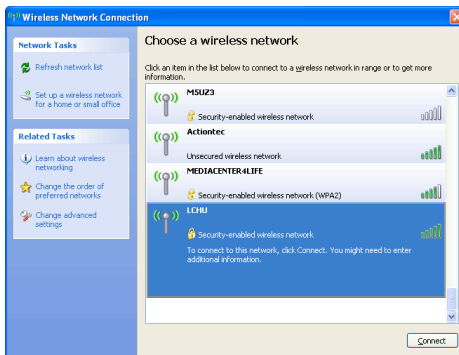

## 3 Setting Up a Wireless Network

### 3.6 Setting Up a Wireless Client

- Click the connection once to mark it, then click **Connect** at the bottom of the screen. The following login window appears, asking for a “Network Key,” which is the pre-shared key used when configuring the FiOS Router’s WPA security (see the “WPA” section in this chapter).

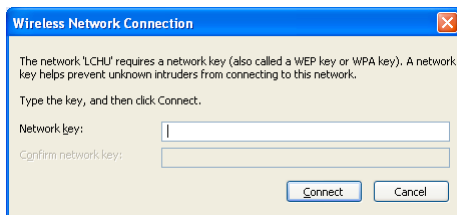

- Enter the network (WPA) key in both text boxes and click **Connect**. After the connection is established, its status will change to “Connected,” as shown below.

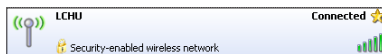

An icon appears in the notification area, announcing the successful initiation of the wireless connection.

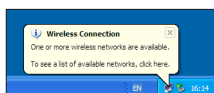

- Test the connection by disabling all other connections in the Network Connections window and surfing the Internet.

## Manual Wireless Network Connection

If the login window shown in step 3 does not appear and the connection attempt fails, configure the connection manually using the following procedure:

1. Click the connection once to mark it and then click **Change Advanced Settings** in the “Related Tasks” box on the left part of the window.

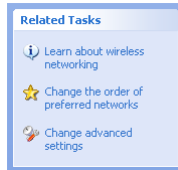

2. The “Wireless Network Connection Properties” window appears. Select **Wireless Networks**.

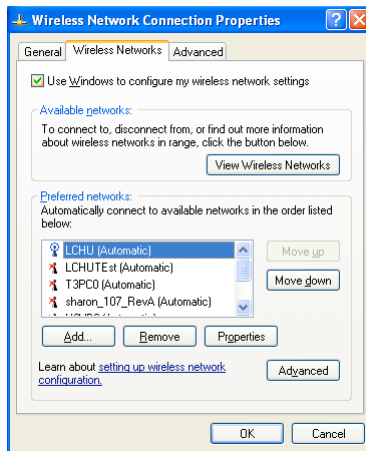

# 3 Setting Up a Wireless Network

## 3.6 Setting Up a Wireless Client

3. Click the connection to highlight it, then click **Properties**. The connection's "Properties Window" appears.

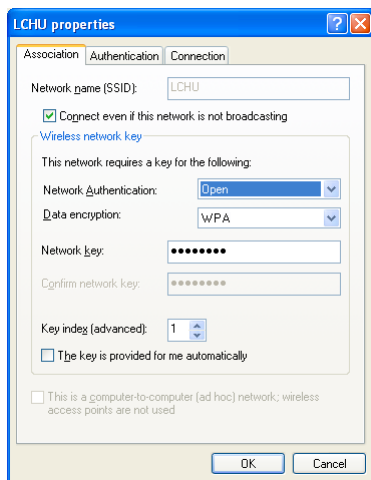

4. From the "Network Authentication" drop-down list, select "Open."
5. From the "Data Encryption" drop-down list, select "WPA."
6. Enter the pre-shared key in both the "Network key" and the "Confirm network key" text boxes.
7. Click **OK**, then **OK** again.
8. When attempting to connect to the wireless network, the login window appears, pre-populated with the pre-shared key. Press **Connect** to connect.

Since the network is now secured, only users who know the pre-shared key will be able to connect.

# 4

- 4.0** Introduction
- 4.1** Accessing the My Network Settings
- 4.2** Using the My Network Settings

# Configuring My Network Settings

Once the FiOS Router is physically connected and the FiOS Router's Main screen is displayed in a web browser, a list of devices connected to the FiOS Router's network appears in the "My Network" column of the screen. From here, basic network settings can be configured.

## 4.1 Accessing My Network Settings

To access My Network, click the “My Network” icon in the Main screen.



The “My Network” screen appears:



On the far right side of the screen, in the “Connected Devices” section, is a list of the devices currently connected to the FiOS Router’s network, sorted by connection type and number. The rest of the screen contains the “My Network” section, which displays each device connected to the FiOS Router’s network, and a series of basic configuration settings for each device.

### 4.2 Using My Network Settings

Various settings can be accessed for a particular device, as follows.

#### 4.2a Access Device

For devices that can be accessed (such as Internet cameras and networked hard drives), locate it in the My Network column, then click **Access Devices** to use the device over the network.

#### 4.2b Access Shared Files

To access the shared files on a particular device, locate the device in the My Network column, then click **Access Shared Files**. A list of shared files appears on the screen.

#### 4.2c Website Blocking

Clicking **Website Blocking** generates the “Parental Control” screen. For more information about using parental controls, see chapter 7, “Using Parental Controls.”

#### 4.2d Block Internet Services

Internet services blocking is used to prevent a device on the network from accessing particular services available on the Internet, such as receiving email or downloading files from FTP sites. To set up Internet services blocking on a networked device:

1. Locate the device in the My Network column, then click **Block Internet Services**. The “Access Control” screen appears.





- Click **Add** in the “Networked computer/Device” column. The “Add Access Control Rule” screen appears.

Add Access Control Rule	
Networked Computer / Device	Any
Protocol	Any
When should this rule occur?	Always
<input type="button" value="Apply"/> <input type="button" value="Cancel"/>	

- If this access control rule applies to all networked devices, select “Any” from the “Networked Computer/Device” list box. If this rule applies to certain devices only, select “User Defined” and click **Add**. Then, in the “Edit Network Object” screen, add a network object (for more details about adding network objects, see the “Advanced Settings” chapter of this manual).
- Select the Internet protocol to be blocked from the “Protocol” drop-down list.
- If this rule will be active continuously, select **Always** from the “When should this rule occur?” drop-down list. If the rule will only be active at certain times, select “User Defined” and click **Add**. Then, add a schedule rule (for more details about schedule rules, see the “Advanced Settings” chapter of this manual).

**Note:** Make sure the FiOS Router’s date and time settings for your time zone are set correctly for schedule rules to function properly.

- Click **Apply** to save the changes. The Access Control screen will display a summary of the access control rule.

**Note:** To block a service that is not included in the list, select “User Defined” from the Protocol drop-down menu. The “Edit Service” screen appears. Define the service, then click Apply. The service will then be automatically added to the top section of the “Add Access Control Rule” screen, and will be selectable.

The user may disable an access control and the service made available without having to remove the service from the Access Control table. This may be useful to make the service available only temporarily, with the expectation that the restriction will be reinstated later.

- To temporarily disable an access control, clear the check box next to the network computer/device.

# 4 Configuring My Network Settings

## 4.2 Using My Network Settings

- To reinstate the restriction at a later time, select the check box next to the network computer/device.
- To remove an access restriction from the Access Control table, click **Remove** for the service. The service will be removed from the Access Control table.

**Note:** When Web Filtering is enabled, HTTP services cannot be blocked by access control.

### 4.2e Port Forwarding

Activating “Port Forwarding” allows the network to be exposed to the Internet in certain limited and controlled ways, enabling some applications to work from the local network (game, voice, and chat applications, for example), as well as allowing Internet access to servers in the local network. To set this up on a networked device, locate the device in the My Network column, then click **Port Forwarding**. The “Port Forwarding” screen appears.

**Port Forwarding**

This feature enables applications (Games, Webcams, IM & Others) by opening a tunnel between remote (Internet) computers and a specific device port inside your local area network(LAN).

Create new port forwarding rule:

IP Address forward to or select from menu    Application to forward...

**Add**   **Reset**   **Cancel**   **Advanced >>**

Applied rules:

Networked Computer / Device	Applications & Ports Forwarded	WAN Connection Type	Status	Delete
localhost 127.0.0.1	Verizon FiOS Service Top Any -> 4567	All Broadband Devices	Active	<b>Delete</b>

**Delete**   **Resolve Now**   **Apply**   **Refresh**

To set up basic port forwarding:

1. Click the arrow next to “IP Address forward to or select from menu” to display a menu and either enter the IP address of the item to port forward from, or choose an item from the drop-down menu.
2. Click the arrow next to “Application to forward...” and select a pre-configured application from the drop-down menu.
3. Click **Add**. The new port forwarding rule appears in the “Applied rules” table at the bottom of the screen.

To set up advanced port forwarding (custom ports):

1. Click the arrow next to "Application to forward..." and select **Custom Ports** from the drop-down menu.
2. Enter the host name (from the drop-down list) or local IP address of the computer providing the service in the "Specify IP" text box. Note that only one local network computer can be assigned to provide a specific service or application.
3. Click **Advanced**.
4. Select the Internet protocol to be provided from the "Protocol" drop-down list. Depending on the protocol selected, additional options appear in the screen.
5. Select the connection with which this port forwarding rule will be active from the "WAN Connection Type" drop-down list.
6. To select a port to forward communications to (this is optional), select "Specify" from the "Forward to Port" drop-down list, then, in the text box that appears, enter the port number. If no port is identified, select "Same as Incoming Port."
7. If this port will be active all the time, select "Always" from the "Schedule" drop-down list. If the rule will only be active at certain times, select "User Defined" and click **Add**. Then, add a schedule rule (for more details about schedule rules, see the "Advanced Settings" chapter of this manual).
8. If source and destination ports need to be specified, select Specify from the drop-down menu list (by clicking on the appropriate arrow), then entering the port numbers.
9. Click **Apply** to save the changes. The new port forwarding rule appears in the "Applied rules" table at the bottom of the screen.

**Note:** Some applications, such as FTP, TFTP, PPTP, and H323, require the support of special specific Application Level Gateway (ALG) modules to work inside the local network. Data packets associated with the aforementioned applications contain information that allows them to be routed correctly. An ALG is needed to handle these packets and ensure they reach their intended destinations. The FiOS Router is equipped with a robust list of ALG modules, enabling maximum functionality in the local network. The ALG is automatically assigned based on the destination port.

# 4 Configuring My Network Settings

## 4.2 Using My Network Settings

### 4.2f View Device Details

To view information about a networked device, or to test a device's connection, locate the device in the My Network column, then click **View Device Details**. The "Device Information" screen appears.

**Device Information**

This screen provides a detailed breakdown for this device.

<b>Host:</b>	FAELAB23
<b>IP Address:</b>	192.168.1.2
<b>Subnet Mask:</b>	255.255.255.0
<b>MAC Address:</b>	00:11:25:a3:75:b1
<b>Network Connection:</b>	Bridge
<b>Lease Type:</b>	Dynamic
<b>Port Forwarding Services:</b>	None
<b>Windows Shared Folders:</b>	\\192.168.1.2\

To test if this device is connected to your broad band home router, click the **Test Connectivity** button.

<b>Ping Test:</b>	<b>Test Connectivity</b>
-------------------	--------------------------

**Close**

1. Click **Test Connectivity**. The "Diagnostics" screen appears.

**Diagnostics**

◆ Diagnostics can assist in testing network connectivity. This feature pings (ICMP echo) an IP address and displays the results, such as the number of packets transmitted and received, round trip time, and success status

**Ping (ICMP Echo)**

<b>Destination:</b>	<input type="text" value="192.168.1.23"/>	<b>Go</b>
<b>Number of pings:</b>	<input type="text" value="4"/>	
<b>Status:</b>	Test Succeeded	
<b>Packets:</b>	4/4 transmitted, 4/4 received, 0% loss	
<b>Round Trip Time:</b>	Minimum = 0 ms Maximum = 0 ms Average = 0 ms	

Press the **Refresh** button to update the status.

**Close** **Refresh**

2. The FiOS Router automatically runs a ping test, and the results are displayed in the Diagnostics screen.

## 4.2g Rename This Device

To rename a networked device, locate the device in the My Network column, then click **Rename This Device**. The “Rename Device” screen appears.



The screenshot shows a web form titled "Rename Device". At the top, it states: "This Page allows you to change the name of this device, and how it is identified on your network:". Below this, there are three sections:

- Current Device Name:** A text box containing "FAELAB23".
- New Name:** A text box containing "FAELAB23".
- New Icon:** A drop-down menu showing "DesktopLaptop" with a small icon of a laptop to its right.

At the bottom of the form, there are two buttons: "Apply" and "Back".

Enter the new name of the device in the “New Name” text box and, if needed, select a new icon for the device from the “New Icon” drop-down list.

# 5

- 5.0** Introduction
- 5.1** Accessing Network Connections
- 5.2** Network (Home/Office) Connection
- 5.3** Ethernet Connection
- 5.4** Wireless Access Point Connection
- 5.5** Coax Connection
- 5.6** Broadband Ethernet Connection
- 5.7** Broadband Coax Connection
- 5.8** WAN PPPoE Connection
- 5.9** WAN PPPoE 2 Connection

# Using Network Connections

The FiOS Router supports various local area network (LAN) and wide area network (WAN, or Internet) connections via Ethernet or coaxial cables. The “Network Connections” screens are used to configure the various aspects of the FiOS Router’s network and Internet connections, and create new connections.









### 5.1 Accessing Network Connections

**Caution!** The settings covered in this chapter should be configured by experienced network technicians only.

To access the FiOS Router's network connections, in the "My Network" screen, click **Network Connections** from the menu on the left side. The "Network Connections" screen appears.

**Network Connections**

**NOTE:** Ignore the WAN PPPoE Status unless you are a PPPoE customer.













Name	Status	Action
Network (Home/Office)	Connected	
Wireless Access Point - Virtual AP	Connected	 
Broadband Connection (Ethernet)	Cable Disconnected	
Broadband Connection (Coax)	Cable Disconnected	
WAN PPPoE	Disabled	
WAN PPPoE 2	Disabled	
Add		

[Full Status](#) [Detect Broadband Connection](#) [Advanced >>](#)

Click **Advanced** to expand the screen and display all connection entries.

**Network Connections**

**NOTE:** Only advanced technical users should use this feature.

Name	Status	Action
Network (Home/Office)	Connected	
Ethernet	1 Ports Connected	
Wireless Access Point	Connected	 
Coax	Cable Disconnected	
Wireless Access Point - Virtual AP	Connected	 
Broadband Connection (Ethernet)	Cable Disconnected	
Broadband Connection (Coax)	Cable Disconnected	
WAN PPPoE	Disabled	
WAN PPPoE 2	Disabled	
Add		

[Full Status](#) [Detect Broadband Connection](#) [Basic <<](#)

To select a connection, click on its name. The rest of this chapter describes the different network connections available on the FiOS Router, as well as the connection types that can be created.



## 5.2 Network (Home/Office) Connection

Select **Network (Home/Office)** in the Network Connections screen to generate the “Network (Home/Office) Properties” screen. This screen displays a list of the local network’s properties. The only modifications that can be made from this screen are disabling the connection (by clicking **Disable**) or renaming the connection (by entering a new name in the “Rule Name” text box).

**Network (Home/Office) Properties**

NOTE: Only advanced technical users should use this feature.

<b>Name:</b>	[Network (Home/Office)] <span style="float: right;"><a href="#">Disable</a></span>
<b>Status:</b>	Connected
<b>Network:</b>	Network (Home/Office)
<b>Underlying Devices:</b>	Ethernet Wireless Access Point Coax Coax Status
<b>Connection Type:</b>	Bridge
<b>MAC Address:</b>	00:18:01:b7:57:52
<b>IP Address:</b>	192.168.1.1
<b>Subnet Mask:</b>	255.255.255.0
<b>IP Address Distribution:</b>	DHCP Server
<b>Received Packets:</b>	498
<b>Sent Packets:</b>	559
<b>Time Span:</b>	0:19:01

[Apply](#)
[Cancel](#)
[Settings](#)

**Note:** When a network is disabled, its formerly underlying devices will not be able to get the DHCP address from the network interface to which they were connected.

The Network (Home/Office) connection is used to combine several network devices under one virtual network. For example, a home/office network can be created for Ethernet and other network devices.

### 5.2a Configuring the Home/Office Network

Click **Settings** in the “Network (Home/Office) Properties” screen to generate a second “Network (Home/Office) Properties” screen.

#### General

The top part of the screen displays general communication parameters. We recommend not changing the default values in this section unless familiar with networking concepts.

Network (Home/Office) Properties	
<small>NOTE: Only advanced technical users should use this feature.</small>	
<b>General</b>	
Status:	Connected
When should this rule occur?:	Always
Network:	Network (Home/Office) ▾
Connection Type:	Bridge
Physical Address:	00:18:01:07:57:52
MTU:	Automatic ▾ 1500
Internet Protocol:	Use the Following IP Address ▾
IP Address:	192.168.1.1
Subnet Mask:	255.255.255.0
Bridge:	Bridge

**Status** Displays the connection status of the network.

**When should this rule occur?** Displays when the rule is active. To schedule rules, see the “Advanced Settings” chapter.

**Network** Select the type of connection being configured from the drop-down list (options: **Broadband Connection**, **Network [Home/Office]**, or **DMZ**).

**Connection Type** Displays the type of connection.

**Physical Address** Displays the physical address of the network card used for the network.

**MTU** MTU (Maximum Transmission Unit) specifies the largest packet size permitted for Internet transmission. “Automatic” sets the MTU at 1500. Other choices include “Automatic by DHCP,” which sets the MTU according to the DHCP connection, and “Manual,” which allows the MTU to be set manually.

## Internet Protocol

This section has three options: **No IP Address**, **Obtain an IP Address Automatically**, and **Use the Following IP Address**.

**No IP Address** Select this option if the connection will have no IP address. This is useful if the connection operates under a bridge.

**Obtain an IP Address Automatically** Select this option if the network connection is required by the ISP to obtain an IP address automatically. The server assigning the IP address also assigns a subnet mask address, which can be overridden by entering another subnet mask address.

**Use the Following IP Address** Select this option if the network connection uses a permanent (static) IP address, then the IP address and subnet mask address.

## Bridge

The “Bridge” section of the Configure Network (Home/Office) screen is used to configure the LAN devices connected to the FiOS Router. By default, the Ethernet, Coax, and Wireless Access Point connections are activated. Do not change these settings unless instructed to do so by the ISP.

**Status** The “Status” column displays the connection status of a particular device.

**STP** Click in the device’s “STP” check box to enable Spanning Tree Protocol on the device. This protocol provides path redundancy while preventing undesirable loops in the network.

**Action** The “Action” column contains an icon that, when clicked, generates the configuration screen of the particular device.

### DNS Server

Domain Name System (DNS) is the method by which website or domain names are translated into IP addresses. Specify such an address manually, according to the information provided by the ISP.

To manually configure DNS server addresses, select **Use the Following DNS Server Addresses**. Specify up to two different DNS server addresses, one primary, the other secondary.

<b>DNS Server</b>	Use the Following DNS Server Addresses ▾
Primary DNS Server:	0 .0 .0 .0
Secondary DNS Server:	0 .0 .0 .0

### IP Address Distribution

The “IP Address Distribution” section of the Configure Network (Home/Office) screen is used to configure the FiOS Router’s Dynamic Host Configuration Protocol (DHCP) server parameters. DHCP automatically assigns IP addresses to network devices. If enabled, make sure to configure the network devices as “DHCP Clients.” There are three options in this section: **Disabled**, **DHCP Server**, and **DHCP Relay**.

**Disabled** Select this option if statically assigning IP addresses to the network devices.

**DHCP Server** To set up the network bridge to function as a DHCP server:

1. Select **DHCP Server**.
2. Enter the IP address at which the FiOS Router starts issuing addresses in the “Start IP Address” text boxes. Since the FiOS Router’s default IP address is 192.168.1.1, the Start IP Address should be 192.168.1.2.
3. Enter the end of the IP address range used to automatically issue IP addresses in the “End IP Address” text boxes. The “maximum” IP address that can be entered here is 192.168.1.254.
4. Enter the subnet mask address in the “Subnet Mask” text boxes. The subnet mask determines which portion of a destination LAN IP address is the network portion, and which portion is the host portion.

5. If Windows Internet Naming Service (WINS) is being used, enter the WINS server address in the "WINS Server" text boxes.
6. Enter the amount of time a network device will be allowed to connect to the FiOS Router with its currently issued dynamic IP address in the "Lease Time in Minutes" text box.
7. Click in the "Provide Host Name If Not Specified by Client" check box to have the FiOS Router automatically assign network devices with a host name, in case a host name is not provided by the user.

**DHCP Relay** Select this option to have the FiOS Router function as a DHCP relay, and enter the IP address in the screen that appears.

## Routing

The FiOS Router can be configured to use static or dynamic routing. Dynamic routing automatically adjusts how packets travel on the network, while static routing specifies a fixed routing path to neighboring destinations. To configure routing:

1. Enter a device metric in the "Device Metric" text box. The device metric is a value used by the FiOS Router to determine whether one route is superior to another, considering parameters such as bandwidth and delay time.
2. Click in the "Default Route" check box to define this device as a default route.
3. Click in the "Multicast - IGMP Proxy Internal" check box to activate multicasting. Multicasting enables the FiOS Router to issue IGMP (Internet Group Management Protocol) host messages on behalf of hosts the FiOS Router discovers through standard IGMP interfaces. IGMP proxy enables the routing of multicast packets according to the IGMP requests of local network devices asking to join multicast groups.

### Routing Table

Clicking **New Route** generates the “New Route” window, where a new route can be configured.

### Additional IP Addresses

Clicking **New IP Address** generates the “Additional IP Address Settings” screen, where additional IP addresses can be created to access the FiOS Router via the Network (Home/Office) connection.

## 5.3 Ethernet Connection

An Ethernet connection connects computers to the FiOS Router using Ethernet cables, either directly or via network hubs and switches. Click **Ethernet** in the Network Connections screen (if needed, click **Advanced** at the bottom of the screen to reveal the “Ethernet” link below “Network [Home/Office]”) to generate the “Ethernet Properties” screen. This screen displays a list of the connection’s properties. The only modifications that can be made from this screen are disabling the connection (by clicking **Disable**) or renaming the connection (by entering a new name in the “Rule Name” text box).

Ethernet Properties	
NOTE: Only advanced technical users should use this feature.	
<a href="#">Disable</a>	
Name:	Ethernet
Status:	1 Ports Connected
Network:	Network (Home/Office)
Connection Type:	Hardware Ethernet Switch
MAC Address:	00:18:01:b7:b7:54
IP Address Distribution:	Disabled
Received Packets:	851
Sent Packets:	3946
Time Span:	0:28:00
<a href="#">Apply</a> <a href="#">Cancel</a> <a href="#">Settings</a>	





**Note:** If disabling the connection, the FiOS Router must be rebooted for the change to take effect.

### 5.3a Configuring the Ethernet Connection

Click **Settings** at the bottom-right of the Ethernet Properties screen to generate another “Ethernet Properties” screen.

**Ethernet Properties**

**NOTE:** Only advanced technical users should use this feature.

<b>General</b>					
Status:	1 Ports Connected				
When should this rule occur?:	Always				
Network:	Network (Home/Office) ▾				
Connection Type:	Hardware Ethernet Switch				
Physical Address:	00:1f:90:7fa3:9e				
MTU:	Automatic ▾ 1500				
<b>Additional IP Addresses</b>					
	IP Address	Subnet Mask	Action		
New IP Address					
HW Switch Ports					
	Port	Status	PVID	VLANs	Action
	Port 1	Connected 1000 Mbps Full-Duplex			
	Port 2	Disconnected			
	Port 3	Disconnected			
	Port 4	Disconnected			

#### General

The top part of the screen displays general communication parameters. We recommend not changing the default values in this section unless familiar with networking concepts.

**Status** Displays the connection status of the Ethernet switch.

**When should this rule occur?** Displays when the rule is active. To schedule rules, see the “Advanced Settings” chapter.

**Network** Select the type of connection being configured from the drop-down list (**Network [Home/Office]**, **Broadband Connection**, or **DMZ**).

**Connection Type** Displays the type of connection.

**Physical Address** Displays the physical address of the network card used for the network.





**MTU** MTU (Maximum Transmission Unit) specifies the largest packet size permitted for Internet transmission. “Automatic” sets the MTU at 1500. Other choices include “Automatic by DHCP,” which sets the MTU according to the DHCP connection, and “Manual,” which allows the MTU to be set manually.

### Additional IP Addresses

Clicking **New IP Address** generates the “Additional IP Address Settings” screen, where additional IP addresses can be created to access the FiOS Router via the Ethernet connection.

### HW Switch Ports

This section displays the connection status of the FiOS Router’s four Ethernet ports.

HW Switch Ports				
Port	Status	PVID	VLANs	Action
Port 0	Connected 100.0 Mbps Full-Duplex			
Port 1	Disconnected			
Port 2	Disconnected			
Port 3	Disconnected			

Clicking on a connection’s “Action” icon (in the column on the right) generates the “Port Settings” screen, where ingress and egress policies can be edited.

**Port 0 Settings**

Enable Switch Port Virtual Device

Port Isolation

**VLAN**

Ingress Policy: Untagged (Do Not Add VLAN Header) ▾

VLAN ID	Egress Policy	Action
Add		



## 5.4 Wireless Access Point Connection

A Wireless Access Point connection connects devices wirelessly. Click **Wireless Access Point** in the Network Connections screen (if needed, click **Advanced** at the bottom of the screen to reveal the “Wireless Access Point” link below “Network [Home/Office]”) to generate the “Wireless Access Point Properties” screen. This screen displays a list of the connection’s properties. The only modifications that can be made from this screen are disabling the connection (by clicking **Disable**) or renaming the connection (by entering a new name in the “Name” text box).

**Wireless Access Point Properties**

NOTE: Only advanced technical users should use this feature.

<b>Name:</b>	<input type="text" value="Wireless Access Point"/>
<b>Status:</b>	Connected
<b>Network:</b>	Network (Home/Office)
<b>Connection Type:</b>	Wireless 802.11g Access Point
<b>MAC Address:</b>	00:1f:90:e0:15:98
<b>IP Address Distribution:</b>	Disabled
<b>Received Packets:</b>	0
<b>Sent Packets:</b>	7439
<b>Time Span:</b>	43:29:20

**Note:** If disabling the connection, the FiOS Router must be rebooted for the change to take effect.

### 5.4a Configure Wireless Access Point

Click **Settings** at the bottom-right of the Wireless Access Point Properties screen generates a second “Wireless Access Point Properties” screen.

**Wireless Access Point Properties**

NOTE: Only advanced technical users should use this feature.

**General**

**Status:** Connected

**When should this rule occur?:** Always

**Network:**

**Connection Type:** Wireless 802.11g Access Point

**Physical Address:** 00:1f:90:e0:15:98

**MTU:**  1500

**Additional IP Addresses**

IP Address	Subnet Mask	Action
<input type="text" value="New IP Address"/>		<input type="button" value="Add"/>

### General

The top part of the screen displays general communication parameters. We recommend not changing the default values in this section unless familiar with networking concepts.

**Status** Displays the status of the wireless access point connection.

**When should this rule occur?** Displays when the rule is active. To schedule rules, see the “Advanced Settings” chapter.

**Network** Select the type of connection being configured from the drop-down list (options: **Network [Home/Office]**, **Broadband Connection**, or **DMZ**).

**Connection Type** Displays the type of connection.

**Physical Address** Displays the physical address of the network card used for the network.

**MTU** MTU (Maximum Transmission Unit) specifies the largest packet size permitted for Internet transmission. “Automatic” sets the MTU at 1500. Other choices include “Automatic by DHCP,” which sets the MTU according to the DHCP connection, and “Manual,” which allows the MTU to be set manually.

### Additional IP Addresses

Clicking **New IP Address** generates the “Additional IP Address Settings” screen, where additional IP addresses can be created to access the FiOS Router via the Wireless Access Point connection.

## 5.5 Coax Connection

A Coax connection connects devices (such as set-top boxes) to the FiOS Router using a coaxial cable. Click **Coax** in the Network Connections screen (if needed, click **Advanced** at the bottom of the screen to reveal the “Coax” link below “Network [Home/Office]”) to generate the “Coax Properties” screen. This screen displays a list of the connection’s properties. The only modifications that can be made from this screen are disabling the connection (by clicking **Disable**) or renaming the connection (by entering a new name in the “Name” text box).

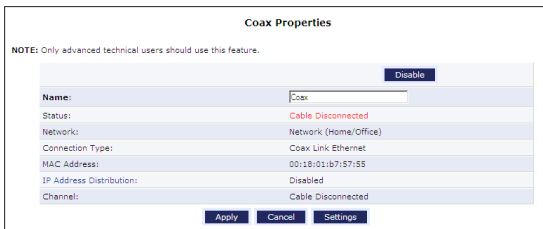

**Note:** If disabling the connection, the FiOS Router must be rebooted for the change to take effect.

### 5.5a Configure Coax

Click **Settings** at the bottom-right of the Coax Properties screen generates a second “Coax Properties” screen.

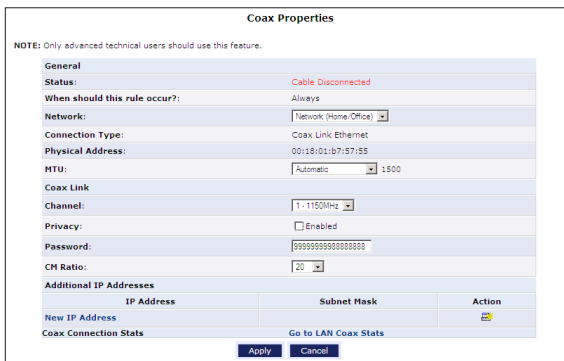

### General

The top part of the screen displays general communication parameters. We recommend not changing the default values in this section unless familiar with networking concepts.

**Status** Displays the status of the coax connection.

**When should this rule occur?** Displays when the rule is active. To schedule rules, see the “Advanced Settings” chapter.

**Network** Select the type of connection being configured from the drop-down list (options: **Network [Home/Office]**, **Broadband Connection**, or **DMZ**).

**Connection Type** Displays the type of connection.

**Physical Address** Displays the physical address of the network card used for the network.

**MTU** MTU (Maximum Transmission Unit) specifies the largest packet size permitted for Internet transmission. “Automatic” sets the MTU at 1500. Other choices include “Automatic by DHCP,” which sets the MTU according to the DHCP connection, and “Manual,” which allows the MTU to be set manually.

### Coax Link

Set up the coax link options in this section of the Configure Coax screen. Options include **Channel**, **Privacy**, and **Password**.

**Channel** Select the Channel from the drop-down list (select from 1-6, or “Automatic”).

**Privacy** Toggle “Privacy” by clicking in the “Enabled” check box. If Privacy is activated, all devices connected via coaxial cable must use the same password. We recommend leaving the Privacy option deactivated.

**Password** Enter the Coax Link password in this text box.

**CM Ratio** Select the CM Ratio from the drop-down menu here.

### Additional IP Addresses

Clicking **New IP Address** generates the “Additional IP Address Settings” screen, where additional IP addresses can be created to access the FiOS Router via the Coax Link Ethernet connection.

### Coax Connection Status

Click **Go to LAN Coax Stats** to generate the “Coax Connection Status” screen, which gives an overview of all the devices connected to the FiOS Router via coaxial cable.

Coax Connection Stats								
<b>NOTE:</b> Only advanced technical users should use this feature, all rates are Mbps. * next to Router or Device represents the Network Coordinator								
<b>Channel:</b>		1 - 1150MHz						
<b>Privacy:</b>		Disabled						
<b>Password:</b>		999999999988888888						
Connection Speed	Router	Device 1	Device 2	Device 3	Device 4	Device 5	Device 6	Device 7
MAC Address	00:18:01:b7:57:55	N/A	N/A	N/A	N/A	N/A	N/A	N/A
IP Address	N/A	N/A	N/A	N/A	N/A	N/A	N/A	N/A
Router	N/A	N/A	N/A	N/A	N/A	N/A	N/A	N/A
Device 1	N/A	N/A	N/A	N/A	N/A	N/A	N/A	N/A
Device 2	N/A	N/A	N/A	N/A	N/A	N/A	N/A	N/A
Device 3	N/A	N/A	N/A	N/A	N/A	N/A	N/A	N/A
Device 4	N/A	N/A	N/A	N/A	N/A	N/A	N/A	N/A
Device 5	N/A	N/A	N/A	N/A	N/A	N/A	N/A	N/A
Device 6	N/A	N/A	N/A	N/A	N/A	N/A	N/A	N/A
Device 7	N/A	N/A	N/A	N/A	N/A	N/A	N/A	N/A
<a href="#">Close</a>								

### 5.6 Broadband Ethernet Connection

A Broadband Ethernet connection connects the FiOS Router to the Internet using an Ethernet cable. Click **Broadband Connection (Ethernet)** from the Network Connections screen to generate the “Broadband Connection (Ethernet) Properties” screen. This screen displays a list of the connection’s properties. The only modifications that can be made from this screen are disabling the connection (by clicking **Disable**) or renaming the connection (by entering a new name in the “Rule Name” text box).

**Broadband Connection (Ethernet) Properties**

**NOTE:** Only advanced technical users should use this feature.

<b>Name:</b>	Broadband Connection (Ethernet)
<b>Status:</b>	Cable Disconnected
<b>Network:</b>	Broadband Connection
<b>Connection Type:</b>	Ethernet
<b>MAC Address:</b>	00:1f:90:ef:f7:52
<b>IP Address Distribution:</b>	Disabled

**Note:** If disabling the connection, the FiOS Router must be rebooted for the change to take effect.

### 5.6a Configuring the Broadband Ethernet Connection

Click **Settings** at the bottom-right of the first Broadband Connection (Ethernet) Properties window to generate another “Broadband Connection (Ethernet) Properties” screen.

**Broadband Connection (Ethernet) Properties**

NOTE: Only advanced technical users should use this feature.

<b>General</b>						
Status:	Cable Disconnected					
When should this rule occur?:	Always					
Network:	Broadband Connection ▾					
Connection Type:	Ethernet					
Physical Address:	00:1f:90:7f:a3:a0					
MTU:	Automatic ▾ 1500					
Internet Protocol:	Obtain an IP Address Automatically ▾					
<input type="checkbox"/> Override Subnet Mask:	0 . 0 . 0 . 0					
DNS Server:	Use the Following DNS Server Addresses ▾					
Primary DNS Server:	0 . 0 . 0 . 0					
Secondary DNS Server:	0 . 0 . 0 . 0					
IP Address Distribution:	Disabled ▾					
Routing Mode:	NAPT ▾					
Device Metric:	3					
<input checked="" type="checkbox"/> Default Route						
<b>Routing Table</b>						
Name	Destination	Gateway	Netmask	Metric	Status	Action
New Route						
<b>Internet Connection Firewall</b>		<input checked="" type="checkbox"/> Enabled				
<small>(This feature provides the ability to change the default firewall setting on this interface. We highly recommend that you not change the default setting).</small>						
<b>Additional IP Addresses</b>						
IP Address	Subnet Mask	Action				
New IP Address						

#### General

The top part of the screen displays general communication parameters. We recommend not changing the default values in this section unless you are familiar with networking concepts.

**Status** Displays the status of the Ethernet connection (“Down,” “Connected,” etc.)

**When should this rule occur?** Displays when the rule is active. To configure rules, see the “Advanced Settings” chapter.

**Network** Select the type of connection being configured from the drop-down list (options: **Network [Home/Office]**, **Broadband Connection**, or **DMZ**).

**Connection Type** Displays the type of connection. Since this is an Ethernet Connection, “Ethernet” is displayed.

**Physical Address** Displays the physical address of the network card used for the network.

**MTU** MTU (Maximum Transmission Unit) specifies the largest packet size permitted for Internet transmission. "Automatic" sets the MTU at 1500. Other choices include "Automatic by DHCP," which sets the MTU according to the DHCP connection, and "Manual," which allows the MTU to be set manually.

#### Internet Protocol

This section includes three options: **No IP Address**, **Obtain an IP Address Automatically**, and **Use the Following IP Address**.

**No IP Address** Select this option if the connection has no IP address. This is useful if the connection is operating under a bridge.

**Obtain an IP Address Automatically** Select this option if the ISP requires the connection to obtain an IP address automatically. The server assigning the IP address also assigns a subnet mask address, which can be overridden by clicking in the "Override Subnet Mask" check box and entering another subnet mask address. Additionally, the DHCP lease can be renewed and/or released by clicking on the appropriate "DHCP Lease" button. The "Expires In" value displays how long until the DHCP lease expires.

**Use the Following IP Address** Select this option if the connection uses a permanent (static) IP address. The ISP should provide this address, along with a subnet mask address, default gateway address, and, optionally, primary and secondary DNS server addresses.

#### DNS Server

The Domain Name System (DNS) is the method by which website or domain names are translated into IP addresses. This connection can be configured to automatically obtain a DNS server address, or an address can be specified manually, according to the information provided by the ISP.

To configure the connection to automatically obtain a DNS server address, select **Obtain DNS Server Address Automatically** from the "DNS Server" drop-down list. To manually configure DNS server addresses, select **Use the Following DNS Server Addresses**. Specify up to two different DNS server addresses, one primary, the other secondary.



## IP Address Distribution

The “IP Address Distribution” section of the Configure Broadband Connection (Ethernet) screen is used to configure the FiOS Router’s Dynamic Host Configuration Protocol (DHCP) server parameters. DHCP automatically assigns IP addresses to network devices. If enabled, make sure to configure the network devices as “DHCP Clients.” There are three options in this section: **Disabled**, **DHCP Server**, and **DHCP Relay**.

**Caution!** We strongly recommend leaving this setting at “Disabled.”

**Disabled** Select this option if statically assigning IP addresses to the network devices.

**DHCP Server** To set up the FiOS Router to function as a DHCP server:

1. Select **DHCP Server**.
2. Enter the IP address at which the FiOS Router starts issuing addresses in the “Start IP Address” text boxes. Since the FiOS Router’s default IP address is 192.168.1.1, the Start IP Address must be 192.168.1.2 or higher.
3. Enter the end of the IP address range used to automatically issue IP addresses in the “End IP Address” text boxes. The “maximum” IP address that can be entered here is 192.168.1.254.
4. Enter the subnet mask address in the “Subnet Mask” text boxes. The subnet mask determines which portion of a destination LAN IP address is the network portion, and which portion is the host portion.
5. If a Windows Internet Naming Service (WINS) is being used, enter the WINS server address in the “WINS Server” text boxes.
6. Enter the amount of time a network device will be allowed to connect to the FiOS Router with its currently issued dynamic IP address in the “Lease Time in Minutes” text box. Just before the time is up, the device’s user will need to make a request to extend the lease or get a new IP address.
7. Click in the “Provide Host Name If Not Specified by Client” check box to have the FiOS Router automatically assign network devices with a host name, in case a host name is not provided by the user.

**DHCP Relay** Select this option to have the FiOS Router function as a DHCP relay. To enter a new IP address for the relay, click **New IP Address**. The “DHCP Relay Server Address” screen appears. Enter the new IP address in the appropriate text boxes, then click **Apply**.

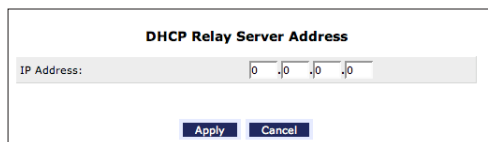

The screenshot shows a web interface for configuring a DHCP relay server. The title is "DHCP Relay Server Address". Below the title is a text input field labeled "IP Address:" with the value "0 .0 .0 .0". At the bottom of the screen are two buttons: "Apply" and "Cancel".

## Routing

**Routing Mode** Select one of the following two Routing modes:

- **Route** - Select this option to cause the FiOS Router to act as a router between two networks.
- **NAPT** - Select this option to activate NAPT (Network Address and Port Translation), which refers to network address translation involving the mapping of port numbers and allows multiple machines to share a single IP address. Use NAPT if the local network contains multiple devices, a topology that necessitates port translation in addition to address translation.

**Device Metric** The device metric is a value used by the FiOS Router to determine whether one route is superior to another, considering parameters such as bandwidth, delay, and more.

**Default Route** Click in this check box to define the connection as a the default route.

**Multicast - IGMP Proxy Default** Click in this check box to enable the FiOS Router to issue IGMP (Internet Group Management Protocol) host messages on behalf of hosts the FiOS Router discovers through standard IGMP interfaces. IGMP proxy enables the routing of multicast packets according to the IGMP requests of local network devices asking to join multicast groups.

## Routing Table

Clicking **New Route** generates the “New Route” window, where a new route can be configured.

## Internet Connection Firewall

Click in the “Enabled” check box to activate the FiOS Router’s firewall on the connection.

## Additional IP Addresses

Clicking **New IP Address** generates the “Additional IP Address Settings” screen, where additional IP addresses can be created to access the FiOS Router via the connection.

## 5.7 Broadband Coax Connection

A Broadband Coax connection connects the FiOS Router to the Internet using a coaxial cable. Click **Broadband Connection (Coax)** in the Network Connections screen to generate the “Broadband Connection (Coax) Properties” screen. This screen displays a list of the connection’s properties. The only modifications that can be made from this screen are disabling the connection (by clicking **Disable**) or renaming the connection (by entering a new name in the “Name” text box).

**Broadband Connection (Coax) Properties**

NOTE: Only advanced technical users should use this feature.

		<b>Disable</b>
<b>Name:</b>	Broadband Connection (Coax)	
<b>Status:</b>	Cable Disconnected	
<b>Network:</b>	Broadband Connection	
<b>Connection Type:</b>	Coax Link Ethernet	
<b>MAC Address:</b>	00:18:01:b7:57:56	
<b>IP Address Distribution:</b>	Disabled	
<b>Channel:</b>	Cable Disconnected	
<b>Apply</b>		<b>Cancel</b> <b>Settings</b>

**Note:** If disabling the connection, the FiOS Router must be rebooted for the change to take effect.

# 5 Using Network Connections

## 5.7 Broadband Coax Connection

### 5.7a Configuring the Broadband Coax Connection

Click **Settings** at the bottom of the Broadband Connection (Coax) Properties screen to generate another “Broadband Connection (Coax ) Properties” screen.

**Broadband Connection (Coax) Properties**

**NOTE:** Only advanced technical users should use this feature.

<b>General</b>						
Status:	Cable Disconnected					
When should this rule occur?:	Always					
Network:	Broadband Connection ▾					
Connection Type:	Coax					
Physical Address:	00:1f:90:7f:a3:a1					
MTU:	Automatic ▾ 1500					
<b>Coax Link</b>						
Auto Detection:	<input checked="" type="radio"/> On <input type="radio"/> Off					
Privacy:	<input checked="" type="checkbox"/> Enabled					
Password:	00066947388374966					
CM Ratio:	20 ▾					
<b>WAN Coax Connection Speeds</b>						
Router Tx (Mbps):	N/A					
Router Rx (Mbps):	N/A					
Internet Protocol	Obtain an IP Address Automatically ▾					
<input type="checkbox"/> Override Subnet Mask:	0 . 0 . 0 . 0					
DHCP Lease:	<a href="#">Renew</a> <a href="#">Release</a>					
DNS Server	Obtain DNS Server Address Automatically ▾					
IP Address Distribution	Disabled ▾					
Routing Mode:	NAPT ▾					
Device Metric:	3					
<input checked="" type="checkbox"/> Default Route						
<b>Routing Table</b>						
Name	Destination	Gateway	Netmask	Metric	Status	Action
New Route						
Internet Connection Firewall	<input checked="" type="checkbox"/> Enabled					
<small>(This feature provides the ability to change the default firewall setting on this interface. We highly recommend that you not change the default setting.)</small>						
<b>Additional IP Addresses</b>						
IP Address	Subnet Mask	Action				
New IP Address						
Coax Connection Stats:	<a href="#">Go to WAN Coax Stats</a>					
<a href="#">Apply</a> <a href="#">Cancel</a>						

## General

The top part of the screen displays general communication parameters. We recommend not changing the default values in this section unless you are familiar with networking concepts.

**Status** Displays the status of the connection (“Down,” “Connected,” etc.).

**When should this rule occur?** Displays when the rule is active. To schedule rules, see the “Advanced Settings” chapter.

**Network** Select the type of connection being configured from the drop-down list (options: **Network [Home/Office]**, **Broadband Connection**, or **DMZ**).

**Connection Type** Displays the type of connection. Since this is a coaxial connection, “Coax” is displayed.

**Physical Address** Displays the physical address of the network card used for the network.

**MTU** MTU (Maximum Transmission Unit) specifies the largest packet size permitted for Internet transmission. “Automatic” sets the MTU at 1500. Other choices include “Automatic by DHCP,” which sets the MTU according to the DHCP connection, and “Manual,” which allows the MTU to be set manually.

## Coax Link

Check and configure the coax link connection in this section of the screen.

**Auto Detection** Select whether you want the FiOS Router to automatically detect a coaxial link here.

**Privacy** Toggle “Privacy” by clicking in the “Enabled” check box. If Privacy is activated, all devices connected via coaxial cable must use the same password. We recommend leaving the Privacy option deactivated.

**Password** Enter the Coax Link password here.

**CM Ratio** Select the CM Ratio from the drop-down menu here.

## WAN Coax Connection Speeds

This section displays the FiOS Router’s Tx and Rx speeds (in Mbps).

### Internet Protocol

This section includes three options: **No IP Address**, **Obtain an IP Address Automatically**, and **Use the Following IP Address**.

**No IP Address** Select this option if the connection has no IP address. This is useful when the connection is operating under a bridge.

**Obtain an IP Address Automatically** Select this option if the ISP requires the connection to obtain an IP address automatically. The server assigning the IP address also assigns a subnet mask address, which can be overridden by clicking in the “Override Subnet Mask” check box and entering another subnet mask address. Additionally, the DHCP lease can be renewed and/or released by clicking on the appropriate “DHCP Lease” button. The “Expires In” value displays how long until the DHCP lease expires.

**Use the Following IP Address** Select if the WAN connection is configured using a permanent (static) IP address. The ISP should provide this address, along with a subnet mask address, default gateway address, and, optionally, primary and secondary DNS server addresses.

### DHCP Lease

Renew or release the current DHCP lease by clicking on the appropriate button.

### DNS Server

The Domain Name System (DNS) is the method by which website or domain names are translated into IP addresses. The connection can be set to automatically obtain a DNS server address, or an address can be set manually, according to information provided by the ISP.

To configure the connection to automatically obtain a DNS server address, select **Obtain DNS Server Address Automatically** from the “DNS Server” drop-down list. To manually configure DNS server addresses, select **Use the Following DNS Server Addresses**. Specify up to two different DNS server addresses, one primary, the other secondary.

## IP Address Distribution

The “IP Address Distribution” section of the Configure Broadband Connection (Coax) screen allows the user to configure the FiOS Router’s Dynamic Host Configuration Protocol (DHCP) server parameters. The DHCP automatically assigns IP addresses to network devices. If enabled, make sure to configure the network devices as “DHCP Clients.” There are three options in this section: **Disabled**, **DHCP Server**, and **DHCP Relay**.

**Caution!** We strongly recommend leaving this setting at “Disabled.”

**Disabled** Select this option if statically assigning IP addresses to the network devices.

**DHCP Server** To set up the Broadband Coax connection to function as a DHCP server:

1. Select **DHCP Server**.
2. Enter the IP address at which the FiOS Router starts issuing addresses in the “Start IP Address” text boxes. Since the FiOS Router’s default IP address is 192.168.1.1, the Start IP Address must be 192.168.1.2.
3. Enter the end of the IP address range used to automatically issue IP addresses in the “End IP Address” text boxes. The “maximum” IP address that can be entered here is 192.168.1.254.
4. Enter the subnet mask address in the “Subnet Mask” text boxes. The subnet mask determines which portion of a destination LAN IP address is the network portion, and which portion is the host portion.
5. If a Windows Internet Naming Service (WINS) is being used, enter the WINS server address in the “WINS Server” text boxes.
6. Enter the amount of time a network device will be allowed to connect to the FiOS Router with its currently issued dynamic IP address in the “Lease Time in Minutes” text box. Just before the time is up, the device’s user will need to make a request to extend the lease or get a new IP address.
7. Click in the “Provide Host Name If Not Specified by Client” check box to have the FiOS Router automatically assign network devices with a host name, in case a host name is not provided by the user.

**DHCP Relay** Select this option to have the FiOS Router function as a DHCP relay, and enter the IP address in the screen that appears.

#### Routing

**Routing Mode** Select one of the following two Routing modes:

- **Route** - Select this option to cause the FiOS Router to act as a router between two networks.
- **NAPT** - Select this option to activate NAPT (Network Address and Port Translation), which refers to network address translation involving the mapping of port numbers and allows multiple machines to share a single IP address. Use NAPT if the local network contains multiple devices, a topology that necessitates port translation in addition to address translation.

**Device Metric** The device metric is a value used by the FiOS Router to determine whether one route is superior to another, considering parameters such as bandwidth, delay, and more.

**Default Route** Click in this check box to define the connection as a the default route.

**Multicast - IGMP Proxy Default** Click in this check box to enable the FiOS Router to issue IGMP (Internet Group Management Protocol) host messages on behalf of hosts the FiOS Router discovers through standard IGMP interfaces. IGMP proxy enables the routing of multicast packets according to the IGMP requests of local network devices asking to join multicast groups.

#### Internet Connection Firewall

Enable or disable the firewall for this interface. It is recommended to keep the firewall enabled for all of the FiOS Router's connection interfaces.

#### Additional IP Addresses

Click **New IP Address** to generate the "Additional IP Address Settings" screen, where additional IP addresses can be created to access the FiOS Router via the connection.



## Coax Connection Stats

Click **Go to WAN Coax Stats** to generate a new window that displays the FiOS Router's WAN Coax connection statistics.

## 5.8 WAN PPPoE Connection

WAN Point-to-Point Protocol over Ethernet (PPPoE) relies on two widely accepted standards: Point-to-Point Protocol and Ethernet. PPPoE enables Ethernet networked computers to exchange information with computers on the Internet. PPPoE supports the protocol layers and authentication widely used in PPP and enables a point-to-point connection to be established in the normally multipoint architecture of Ethernet. A discovery process in PPPoE determines the Ethernet MAC address of the remote device in order to establish a session.

Click **WAN PPPoE** in the Network Connections screen to generate the "WAN PPPoE Properties" screen. This screen displays a list of the connection's properties. The only modifications that can be made from this screen are disabling the connection (by clicking **Disable**) or renaming the connection (by entering a new name in the "Name" text box).

**WAN PPPoE Properties**

NOTE: Only advanced technical users should use this feature.

<b>Name:</b>	<input type="text" value="WAN PPPoE"/>
<b>Status:</b>	Disabled
<b>Network:</b>	Broadband Connection
<b>Underlying Device:</b>	Broadband Connection (Ethernet)
<b>Connection Type:</b>	PPPoE
<b>Service Name:</b>	
<b>User Name:</b>	verizonfios

### 5.8a Configuring the WAN PPPoE Connection

Click **Settings** in the WAN PPPoE Properties screen to generate another “WAN PPPoE Properties” screen.

WAN PPPoE Properties	
<b>NOTE:</b> Only advanced technical users should use this feature.	
<b>General</b>	
Status:	Disabled
When should this rule occur?:	Always
Network:	Broadband Connection
Connection Type:	PPPoE
MTU:	Automatic 1492
Underlying Connection:	Broadband Connection (Ethernet)
Service Name (should be filled only if specified by provider):	
<input type="checkbox"/> On Demand (will attempt to connect only when packets are sent)	
Time Between Reconnect Attempts:	30 Seconds
<b>PPP Authentication</b>	
Login User Name (case sensitive):	verizonfcs
Login Password:	*****
Retype Password:	*****
<input checked="" type="checkbox"/> Support Unencrypted Password (PAP)	
<input checked="" type="checkbox"/> Support Challenge Handshake Authentication (CHAP)	
<input checked="" type="checkbox"/> Support Microsoft CHAP (MS-CHAP)	
<input checked="" type="checkbox"/> Support Microsoft CHAP Version 2 (MS-CHAP v2)	
<b>PPP Compression</b>	
BSD:	Allow
Deflate:	Allow
Internet Protocol	Obtain an IP Address Automatically
<input type="checkbox"/> Override Subnet Mask:	0 .0 .0 .0
DNS Server	Obtain DNS Server Address Automatically

#### General

The top part of the screen displays general communication parameters. We recommend not changing the default values in this section unless familiar with networking concepts.

**Status** Displays the connection status of the WAN PPPoE connection. (“Down,” “Disabled,” “Connected,” etc.)

**When should this rule occur?** Displays when the rule is active. To schedule rules, see “Advanced Settings” chapter.

**Network** Select the type of connection being configured from the drop-down list (**Broadband Connection**, **Network (Home/Office)**, or **DMZ**).

**Connection Type** Displays the type of connection. Since this is PPPoE connection, “PPPoE” is displayed.

**MTU** MTU (Maximum Transmission Unit) specifies the largest packet size permitted for Internet transmission. “Automatic,” sets the MTU at 1492. Other choices include “Automatic,” which sets the MTU according to the connection to the ISP, and “Manual,” which allows the MTU to be set manually.

**Underlying Connection** Specify the underlying connection above which the protocol initiates from the drop-down list, which displays all possible underlying devices.

### PPP Configuration

Point-to-Point Protocol (PPP) is the most popular method for transporting packets between the user and the ISP.

**Service Name** Specify the networking peer’s service name, if provided by the ISP, in this text box.

**On-Demand** To use PPP on demand to initiate the point-to-point protocol session only when packets are actually sent over the Internet, click in this check box. This option should be active on a limited basis

**Idle Time Before Hanging Up** Enter the amount of idle time, in minutes, before the PPP session automatically ends .

**Time Between Reconnect Attempts** In this text box, specify the duration between PPP reconnect attempts, as provided by the ISP.

### PPP Authentication

Point-to-Point Protocol (PPP) currently supports four authentication protocols: **Password Authentication Protocol (PAP)**, **Challenge Handshake Authentication Protocol (CHAP)**, and **Microsoft CHAP versions 1 and 2**. Select the authentication protocols the FiOS Router may use when negotiating with a PPTP server in this section. Select all the protocols if no information is available about the server’s authentication methods. Note that encryption is performed only if Microsoft CHAP, Microsoft CHAP version 2, or both are selected.

**Warning:** The PPP Authentication settings should not be changed unless instructed to do so by your ISP.

**Login User Name** Enter the user name (provided by the ISP) in this text box.

**Login Password** Enter the password (provided by the ISP) in this text box.

**Support Unencrypted Password (PAP)** Password Authentication Protocol (PAP) is a simple, plain-text authentication scheme. The user name and password are requested by the networking peer in plain-text. PAP, however, is not a secure authentication protocol. Man-in-the-middle attacks can easily determine the remote access client's password. PAP offers no protection against replay attacks, remote client impersonation, or remote server impersonation.

**Support Challenge Handshake Authentication (CHAP)** Click in this check box to activate CHAP, a challenge-response authentication protocol that uses MD5 to hash the response to a challenge. CHAP protects against replay attacks by using an arbitrary challenge string per authentication attempt.

**Support Microsoft CHAP** Click in this check box if communicating with a peer that uses Microsoft CHAP authentication protocol.

**Support Microsoft CHAP Version 2** Select this check box if communicating with a peer that uses Microsoft CHAP Version 2 authentication protocol.

### PPP Compression

The PPP Compression Control Protocol (CCP) is responsible for configuring, enabling, and disabling data compression algorithms on both ends of the point-to-point link. It is also used to signal a failure of the compression/decompression mechanism in a reliable manner.

For each compression algorithm (**BSD** and **Deflate**), select one of the following from the drop-down list:

**Reject** Selecting this option rejects PPP connections with peers that use the compression algorithm. If Reject is activated, throughput may diminish.

**Allow** Selecting this option allows PPP connections with peers that use the compression algorithm.

**Require** Selecting this option insures a connection with a peer using the compression algorithm.

## Internet Protocol

Select one of the following Internet Protocol options from the “Internet Protocol” drop-down list:

**Obtain an IP Address Automatically** This option is selected by default. Change only if required by the ISP. The server that assigns the FiOS Router with an IP address also assigns a subnet mask. Override the dynamically assigned subnet mask by selecting the “Override Subnet Mask” and entering a different subnet mask.

**Use the Following IP Address** Select this option to configure the FiOS Router to use a permanent (static) IP address. The ISP should provide this address.

## DNS Server

The Domain Name System (DNS) is the method by which website or domain names are translated into IP addresses. The FiOS Router can be configured to automatically obtain a DNS server address, or the address can be entered manually, according to the information provided by the ISP.

To configure the connection to automatically obtain a DNS server address, select **Obtain DNS Server Address Automatically** from the “DNS Server” drop-down list. To manually configure DNS server addresses, select **Use the Following DNS Server Addresses** from the “DNS Server” drop-down list. Up to two different DNS server addresses can be entered (Primary and Secondary).

## Routing

**Routing Mode** Select one of the following two Routing modes:

- **Route** - Select this option to cause the FiOS Router to act as a router between two networks.
- **NAPT** - Select this option to activate NAPT (Network Address and Port Translation), which refers to network address translation involving the mapping of port numbers and allows multiple machines to share a single IP address. Use NAPT if the local network contains multiple devices, a topology that necessitates port translation in addition to address translation.

**Device Metric** The device metric is a value used by the FiOS Router to determine whether one route is superior to another, considering parameters such as bandwidth, delay, and more.

**Default Route** Click in this check box to define the connection as the default route.

**Multicast - IGMP Proxy Default** Click in this check box to enable the FiOS Router to issue IGMP (Internet Group Management Protocol) host messages on behalf of hosts the FiOS Router discovers through standard IGMP interfaces. IGMP proxy enables the routing of multicast packets according to the IGMP requests of local network devices asking to join multicast groups.

### Routing Table

Clicking **New Route** generates the “New Route” screen, where a new route can be configured.

### Internet Connection Firewall

Click in the “Enabled” check box to activate the FiOS Router’s firewall on the WAN PPPoE connection.

## 5.9 WAN PPPoE 2 Connection

Click **WAN PPPoE 2** in the Network Connections screen to generate the “WAN PPPoE 2 Properties” screen. WAN PPPoE 2 is used for the FiOS Router’s PPPoE connections over coaxial cable. This screen displays a list of the connection’s properties. The only modifications that can be made from this screen are disabling the connection (by clicking **Disable**) or renaming the connection (by entering a new name in the “Name” text box).

The screenshot shows the "WAN PPPoE 2 Properties" configuration window. At the top, there is a title bar and a note: "NOTE: Only advanced technical users should use this feature." Below the note is a table of properties. The "Name" property has a text input field containing "WAN PPPoE 2". The "Status" property is set to "Disabled" and has a blue "Enable" button next to it. The "Network" property is "Broadband Connection". The "Underlying Device" property is "Broadband Connection (Coax)". The "Connection Type" property is "PPPoE". The "Service Name" property is "verizonios". The "User Name" property is "verizonios". At the bottom of the window are three buttons: "Apply", "Cancel", and "Settings".

WAN PPPoE 2 Properties	
NOTE: Only advanced technical users should use this feature.	
	<input type="button" value="Enable"/>
Name:	<input type="text" value="WAN PPPoE 2"/>
Status:	Disabled
Network:	Broadband Connection
Underlying Device:	Broadband Connection (Coax)
Connection Type:	PPPoE
Service Name:	verizonios
User Name:	verizonios
<input type="button" value="Apply"/> <input type="button" value="Cancel"/> <input type="button" value="Settings"/>	

### 5.9a Configuring the WAN PPPoE 2 Connection

Click **Settings** in the WAN PPPoE 2 Properties screen to generate another “WAN PPPoE Properties” screen.

**WAN PPPoE 2 Properties**

**NOTE:** Only advanced technical users should use this feature.

<b>General</b>	
<b>Status:</b>	Disabled
<b>When should this rule occur?:</b>	Always
<b>Network:</b>	Broadband Connection ▾
<b>Connection Type:</b>	PPPoE
<b>MTU:</b>	Automatic ▾ 1492
<b>Underlying Connection:</b>	Broadband Connection (Coax) ▾
<b>Service Name (should be filled only if specified by provider):</b>	<input type="text"/>
<input type="checkbox"/> On Demand (will attempt to connect only when packets are sent)	
<b>Time Between Reconnect Attempts:</b>	30 Seconds
<b>PPP Authentication</b>	
<b>Login User Name (case sensitive):</b>	verizonfios
<b>Login Password:</b>	*****
<b>Retype Password:</b>	*****
<input checked="" type="checkbox"/> Support Unencrypted Password (PAP)	
<input checked="" type="checkbox"/> Support Challenge Handshake Authentication (CHAP)	
<input checked="" type="checkbox"/> Support Microsoft CHAP (MS-CHAP)	
<input checked="" type="checkbox"/> Support Microsoft CHAP Version 2 (MS-CHAP v2)	
<b>PPP Compression</b>	
<b>BSD:</b>	Allow ▾
<b>Deflate:</b>	Allow ▾

#### General

The top part of the screen displays general communication parameters. We recommend not changing the default values in this section unless familiar with networking concepts.

**Status** Displays the connection status of the WAN PPPoE connection. (“Down,” “Disabled,” “Connected,” etc.)

**When should this rule occur?** Displays when the rule is active. To schedule rules, see “Advanced Settings” chapter.

**Network** Select the type of connection being configured from the drop-down list (**Broadband Connection**, **Network (Home/Office)**, or **DMZ**).

**Connection Type** Displays the type of connection. Since this is PPPoE connection, "PPPoE" is displayed.

**MTU** MTU (Maximum Transmission Unit) specifies the largest packet size permitted for Internet transmission. "Automatic," sets the MTU at 1492. Other choices include "Automatic," which sets the MTU according to the connection to the ISP, and "Manual," which allows the MTU to be set manually.

**Underlying Connection** Specify the underlying connection above which the protocol initiates from the drop-down list, which displays all possible underlying devices.

#### PPP Configuration

Point-to-Point Protocol (PPP) is the most popular method for transporting packets between the user and the ISP.

**Service Name** Specify the networking peer's service name, if provided by the ISP, in this text box.

**On-Demand** To use PPP on demand to initiate the point-to-point protocol session only when packets are actually sent over the Internet, click in this check box. This option should be active on a limited basis

**Idle Time Before Hanging Up** Enter the amount of idle time, in minutes, before the PPP session automatically ends .

**Time Between Reconnect Attempts** In this text box, specify the duration between PPP reconnect attempts, as provided by the ISP.

#### PPP Authentication

Point-to-Point Protocol (PPP) currently supports four authentication protocols: **Password Authentication Protocol (PAP)**, **Challenge Handshake Authentication Protocol (CHAP)**, and **Microsoft CHAP versions 1 and 2**. Select the authentication protocols the FiOS Router may use when negotiating with a PPTP server in this section. Select all the protocols if no information is available about the server's authentication methods. Note that encryption is performed only if Microsoft CHAP, Microsoft CHAP version 2, or both are selected.

**Warning:** The PPP Authentication settings should not be changed unless instructed to do so by your ISP.



**Login User Name** Enter the user name (provided by the ISP) in this text box.

**Login Password** Enter the password (provided by the ISP) in this text box.

**Support Unencrypted Password (PAP)** Password Authentication Protocol (PAP) is a simple, plain-text authentication scheme. The user name and password are requested by the networking peer in plain-text. PAP, however, is not a secure authentication protocol. Man-in-the-middle attacks can easily determine the remote access client's password. PAP offers no protection against replay attacks, remote client impersonation, or remote server impersonation.

**Support Challenge Handshake Authentication (CHAP)** Click in this check box to activate CHAP, a challenge-response authentication protocol that uses MD5 to hash the response to a challenge. CHAP protects against replay attacks by using an arbitrary challenge string per authentication attempt.

**Support Microsoft CHAP** Click in this check box if communicating with a peer that uses Microsoft CHAP authentication protocol.

**Support Microsoft CHAP Version 2** Select this check box if communicating with a peer that uses Microsoft CHAP Version 2 authentication protocol.

### PPP Compression

The PPP Compression Control Protocol (CCP) is responsible for configuring, enabling, and disabling data compression algorithms on both ends of the point-to-point link. It is also used to signal a failure of the compression/decompression mechanism in a reliable manner.

For each compression algorithm (**BSD** and **Deflate**), select one of the following from the drop-down list:

**Reject** Selecting this option rejects PPP connections with peers that use the compression algorithm. If Reject is activated, throughput may diminish.

**Allow** Selecting this option allows PPP connections with peers that use the compression algorithm.

**Require** Selecting this option insures a connection with a peer using the compression algorithm.

### Internet Protocol

Select one of the following Internet Protocol options from the “Internet Protocol” drop-down list:

**Obtain an IP Address Automatically** This option is selected by default. Change only if required by the ISP. The server that assigns the FiOS Router with an IP address also assigns a subnet mask. Override the dynamically assigned subnet mask by selecting the “Override Subnet Mask” and entering a different subnet mask.

**Use the Following IP Address** Select this option to configure the FiOS Router to use a permanent (static) IP address. The ISP should provide this address.

### DNS Server

The Domain Name System (DNS) is the method by which website or domain names are translated into IP addresses. The FiOS Router can be configured to automatically obtain a DNS server address, or the address can be entered manually, according to the information provided by the ISP.

To configure the connection to automatically obtain a DNS server address, select **Obtain DNS Server Address Automatically** from the “DNS Server” drop-down list. To manually configure DNS server addresses, select **Use the Following DNS Server Addresses** from the “DNS Server” drop-down list. Up to two different DNS server addresses can be entered (Primary and Secondary).

### Routing

**Routing Mode** Select one of the following two Routing modes:

- **Route** - Select this option to cause the FiOS Router to act as a router between two networks.
- **NAPT** - Select this option to activate NAPT (Network Address and Port Translation), which refers to network address translation involving the mapping of port numbers and allows multiple machines to share a single IP address. Use NAPT if the local network contains multiple devices, a topology that necessitates port translation in addition to address translation.

**Device Metric** The device metric is a value used by the FiOS Router to determine whether one route is superior to another, considering parameters such as bandwidth, delay, and more.

**Default Route** Click in this check box to define the connection as the default route.

**Multicast - IGMP Proxy Default** Click in this check box to enable the FiOS Router to issue IGMP (Internet Group Management Protocol) host messages on behalf of hosts the FiOS Router discovers through standard IGMP interfaces. IGMP proxy enables the routing of multicast packets according to the IGMP requests of local network devices asking to join multicast groups.

### Routing Table

Clicking **New Route** generates the “New Route” screen, where a new route can be configured.

### Internet Connection Firewall

Click in the “Enabled” check box to activate the FiOS Router’s firewall on the WAN PPPoE connection.

# 6

- 6.0** Introduction
- 6.1** Overview
- 6.2** Firewall
- 6.3** Access Control
- 6.4** Port Forwarding
- 6.5** DMZ Host
- 6.6** Port Triggering
- 6.7** Remote Administration
- 6.8** Static NAT
- 6.9** Advanced Filtering
- 6.10** Security Log

# Configuring Security Settings

The FiOS Router's security suite includes comprehensive and robust security services: Stateful Packet Inspection, firewall security, user authentication protocols, and password protection mechanisms. These features help protect users' computers from security threats on the Internet.

### 6.1 Overview

This chapter covers the following security features:

- **Firewall** - select the security level for the firewall.
- **Access Control** - restrict access from the local network to the Internet.
- **Port Forwarding** - enable access from the Internet to specified services provided by computers on the local network.
- **DMZ Host** - configure a network host to receive all traffic arriving at the FiOS Router which does not belong to a known session.
- **Port Triggering** - define port triggering entries to dynamically open the firewall for some protocols or ports.
- **Remote Administration** - enable remote configuration of the FiOS Router from any Internet-accessible computer.
- **Static NAT** - allow multiple static NAT IP addresses to be designated to devices on the network.
- **Advanced Filtering** - control the firewall's settings and rules.
- **Security Log** - view and configure the security log.

## 6.2 Firewall

The FiOS Router's firewall is the cornerstone of the FiOS Router's security suite. It has been exclusively tailored to the needs of the residential/office user and is pre-configured to provide optimum security.

The firewall provides both the security and flexibility home and office users seek. It provides a managed, professional level of network security while enabling the safe use of interactive applications, such as Internet gaming and video-conferencing.

Additional features, including surfing restrictions and access control, can also be configured locally through the FiOS Router's GUI, or remotely by a service provider.

The firewall also supports advanced filtering, designed to allow comprehensive control over the firewall's behavior. Specific input and output rules can be defined, the order of logically similar sets of rules can be controlled, and distinctions between rules that apply to Internet and local network devices can be made.

The firewall regulates the flow of data between the local network and the Internet. Both incoming and outgoing data are inspected and then either accepted (allowed to pass through the FiOS Router) or rejected (barred from passing through the FiOS Router) according to a flexible and configurable set of rules. These rules are designed to prevent unwanted intrusions from the outside, while allowing local network users access to required Internet services.

The firewall rules specify what types of services available on the Internet can be accessed from the local network and what types of services available in the local network can be accessed from the Internet. Each request for a service the firewall receives, whether originating in the Internet or from a computer in the local network, is checked against the firewall rules to determine whether the request should be allowed to pass through the firewall. If the request is permitted to pass, all subsequent data associated with this request (a "session") will also be allowed to pass, regardless of its direction.

# 6 Configuring Security Settings

## 6.2 Firewall

For example, when accessing a website on the Internet, a request is sent out to the Internet for this site. When the request reaches the FiOS Router, the firewall identifies the request type and origin (HTTP and a specific computer in the local network, in this case). Unless the FiOS Router is configured to block requests of this type from this computer, the firewall allows this request to pass out onto the Internet. When the website is returned from the web server, the firewall will associate it with this session and allow it to pass, regardless of whether HTTP access from the Internet to the local network is blocked or permitted.

Note that it is the origin of the request, not subsequent responses to this request, which determines whether a session can be established or not.

### 6.2a General Screen

The “General” screen is used to configure the FiOS Router’s basic firewall settings.





The FiOS Router features three pre-defined firewall security levels: **Maximum**, **Typical**, and **Minimum**. The table below summarizes the behavior of the FiOS Router for each of the three security levels.

Security Level	Internet requests (incoming traffic)	Local network requests (outgoing traffic)
<b>Maximum Security</b>	<b>Blocked</b> - No access to local network from Internet, except as configured in the Port Forwarding, DMZ host, and Remote Access screens.	<b>Limited</b> - Only commonly used services, such as web browsing and email, are permitted.
<b>Typical Security</b>	<b>Blocked</b> - No access to local network from Internet, except as configured in the Port Forwarding, DMZ host, and Remote Access screens.	<b>Unrestricted</b> - All services are permitted, except as configured in the Access Control screen.
<b>Minimum Security</b>	<b>Unrestricted</b> - Permits full access from Internet to local network; all connection attempts are permitted.	<b>Unrestricted</b> - All services are permitted, except as configured in the Access Control screen.

These services include Telnet, FTP, HTTP, HTTPS, DNS, IMAP, POP3 and SMTP.

**Note:** Some applications (such as some Internet messengers and peer-to-peer client applications) tend to use these ports if they cannot connect with their own default ports. When applying this behavior, these applications will not be blocked outbound, even at the Maximum Security level.

## 6 Configuring Security Settings

### 6.3 Access Control

To configure the FiOS Router's firewall security settings:

1. From the General screen, select a security level by clicking the appropriate radio button. Using the Minimum Security setting may expose the local network to significant security risks, and thus should only be used for short periods of time.
2. Check the "Block IP Fragments" box to protect the local network from a common type of hacker attack that uses fragmented data packets to sabotage the network. Note that VPN over IPsec and some UDP-based services make legitimate use of IP fragments. IP fragments must be allowed to pass into the local network to use these services.
3. Click **Apply** to save changes.

### 6.3 Access Control

Access control is used to block specific computers within the local network (or even the whole network) from accessing certain services on the Internet. For example, one computer can be prohibited from surfing the Internet, another computer from transferring files using FTP, and the whole network from receiving incoming email.

Access control defines restrictions on the types of requests that can pass from the local network out to the Internet, and thus may block traffic flowing in both directions. In the email example given above, computers in the local network can be prevented from receiving email by blocking their outgoing requests to POP3 servers on the Internet.

Access control also incorporates a list of preset services in the form of applications and common port settings.

### 6.3a Allow or Restrict Services

To view and allow/restrict these services:

1. Select **Access Control** from the left side of any Security screen. The “Access Control” screen appears.

**Note:** The “Allowed” section is only visible when the firewall is set to “Maximum.”

**Access Control**  
Block Internet Services / Protocols like, E-mail or Internet access for any computer on your network.

<b>Blocked</b>				
Networked Computer / Device	Network Address	Protocols	Status	Action
<b>Add</b>				
<b>Allowed</b>				
Networked Computer / Device	Network Address	Protocols	Status	Action
<input checked="" type="checkbox"/> Any	Any	DHCP - UDP 67-68 -> 67	Active	
<input checked="" type="checkbox"/> Any	Any	DNS - TCP 53 -> 53 TCP 1024-65535 -> 53 UDP 53 -> 53 UDP 1024-65535 -> 53	Active	
<input checked="" type="checkbox"/> Any	Any	IMAP - TCP Any -> 143	Active	
<input checked="" type="checkbox"/> Any	Any	SMTP - TCP Any -> 25	Active	
<input checked="" type="checkbox"/> Any	Any	POP3 - TCP Any -> 110	Active	
<input checked="" type="checkbox"/> Any	Any	HTTPS - TCP Any -> 443	Active	
<input checked="" type="checkbox"/> Any	Any	HTTP - TCP Any -> 80	Active	
<input checked="" type="checkbox"/> Any	Any	FTP - TCP Any -> 21	Active	
<input checked="" type="checkbox"/> Any	Any	Telnet - TCP Any -> 23	Active	
<b>Add</b>				

Apply
Cancel
Resolve Now
Refresh

## 6 Configuring Security Settings

### 6.3 Access Control

2. Click **Add**. The “Add Access Control Rule” screen appears.

**Note:** To block a service, click **Add** in the “Blocked” section of the Access Control screen. To allow outgoing traffic, click **Add** in the “Allowed” section of the screen.



Add Access Control Rule	
Networked Computer / Device	Any
Protocol	Any
When should this rule occur?	Always
<input type="button" value="Apply"/> <input type="button" value="Cancel"/>	

3. If this access control rule applies to all networked devices, select **Any** from the “Networked Computer/Device” list box. If this rule applies to certain devices only, select **User Defined** and click **Add**. Then, create and add a network object (for more details about adding network objects, see the “Advanced Settings” chapter of this manual).
4. Select the Internet protocol to be allowed or blocked from the “Protocol” drop-down list.
5. If the rule will be active all the time, select **Always** from the “When should this rule occur?” drop-down list. If the rule will only be active at certain times, select **User Defined** and click **Add**. Then, add a schedule rule (for more details about schedule rules, see the “Advanced Settings” chapter of this manual).
6. Click **Apply** to save the changes. The Access Control screen will display a summary of the new access control rule.

**Note:** To block a service not included in the list, select **User Defined** from the Protocol drop-down menu. The “Edit Service” screen appears. Define the service, then click **OK**. The service will then be automatically added to the top section of the “Add Access Control Rule” screen, and will be selectable.

An access control can be disabled and the service made available without having to remove the service from the Access Control table. This may be useful to make the service available temporarily, with the expectation that the restriction will be reinstated later.

- To temporarily disable an access control, clear the check box next to the service name.

- To reinstate the restriction at a later time, select the check box next to the service name.
- To remove an access restriction from the Access Control table, click **Remove** for the service. The service will be removed from the Access Control table.

## 6.4 Port Forwarding

Activating “Port Forwarding” allows the network to be exposed to the Internet in certain limited and controlled ways, enabling some applications to work from the local network (game, voice, and chat applications, for example), as well as allowing Internet access to servers in the local network. To set this up on a networked device, locate the device in the My Network column, then click **Port Forwarding**. The “Port Forwarding” screen appears.

**Port Forwarding**

This feature enables applications (Games, Webcams, IM & Others) by opening a tunnel between remote (Internet) computers and a specific device port inside your local area network(LAN).

**Create new port forwarding rule:**

IP Address forward to or select from menu

**Applied rules:**

Networked Computer / Device	Applications & Ports Forwarded	WAN Connection Type	Status	Delete
localhost 127.0.0.1	Verizon FiOS Service Top Attr-> 4567	All Broadband Devices	Active	

To set up basic port forwarding:

1. Click the arrow next to “IP Address forward to or select from menu” to display a menu and either enter the IP address of the item to port forward from, or choose an item from the drop-down menu.
2. Click the arrow next to “Application to forward...” and select a pre-configured application from the drop-down menu.
3. Click **Apply**. The new port forwarding rule appears in the “Applied rules” table at the bottom of the screen.

To set up advanced port forwarding (custom ports):

1. Click the arrow next to “Application to forward...” and select **Custom Ports** from the drop-down menu.

## 6 Configuring Security Settings

### 6.4 Port Forwarding

2. Enter the host name (from the drop-down list) or local IP address of the computer providing the service in the “Specify IP” text box. Note that only one local network computer can be assigned to provide a specific service or application.
3. Click **Advanced**.
4. Select the Internet protocol to be provided from the “Protocol” drop-down list. Depending on the protocol selected, additional options appear in the screen.
5. Select the connection with which this port forwarding rule will be active from the “WAN Connection Type” drop-down list.
6. To select a port to forward communications to (this is optional), select “Specify” from the “Forward to Port” drop-down list, then, in the text box that appears, enter the port number. If no port is identified, select “Same as Incoming Port.”
7. If this port will be active all the time, select “Always” from the “Schedule” drop-down list. If the rule will only be active at certain times, select “User Defined” and click **Add**. Then, add a schedule rule (for more details about schedule rules, see the “Advanced Settings” chapter of this manual).
8. If source and destination ports need to be specified, select Specify from the drop-down menu list (by clicking on the appropriate arrow), then entering the port numbers.
9. Click **Apply** to save the changes. The new port forwarding rule appears in the “Applied rules” table at the bottom of the screen.

How many computers can use a service or play a game simultaneously? The answer may be a bit confusing. All the computers on the network can behave as clients and use a specific service simultaneously. Being a client means the computer within the network initiates the connection; for example, a computer on the network can open an FTP connection with an FTP server on the Internet. But only one computer on the network can operate as a server and respond to requests from computers on the Internet (outside the local network).

## 6.5 DMZ Host

The DMZ (De-Militarized Zone) host feature allows one device on the network to operate outside the firewall. Designate a DMZ host:

- To use an Internet service, such as an online game or video-conferencing program, not present in the Port Forwarding list and for which no port range information is available.
- To expose one computer to all services without restriction or security.

**Warning:** A DMZ host is not protected by the firewall and may be vulnerable to attack. Designating a DMZ host may also put other computers in the local network at risk. When designating a DMZ host, consider the security implications and protect it if necessary.

To designate a local computer as a DMZ host:

1. Select **DMZ Host** from the left side of any Security screen. The “DMZ Host” screen appears.

**DMZ Host**

Allow a single networked computer/device to be fully exposed to the Internet

**NOTE:** If you have purchased a group of Static IPs and have enabled Static NAT for all of your static IPs, do NOT enable the DMZ Host feature.

DMZ Host IP Address: 192.168.1.0

2. Click in the “DMZ Host IP Address” check box, then enter the IP address of the computer to be designated as a DMZ host. Note that only one network computer can be a DMZ host at any time.
3. Click **Apply**.

Click in the “DMZ Host IP Address” check box again to disable the DMZ host.

### 6.6 Port Triggering

Port triggering can be described as dynamic port forwarding. By setting port triggering rules, inbound traffic will be allowed to arrive at a specific network host using ports different than those used for outbound traffic. When using port triggering, the outbound traffic triggers the ports at which inbound traffic is directed.

For example, a gaming server is accessed using UDP protocol on port 2222. The gaming server then responds by connecting the user using UDP on port 3333 when a gaming session is initiated. In this case, port triggering must be used, since it conflicts with the following default firewall settings:

- The firewall blocks inbound traffic by default.
- The server replies to the FiOS Router's IP, and the connection is not sent back to the host, since it is not part of a session.

To resolve the conflict, a port triggering entry must be defined, which allows inbound traffic on UDP port 3333 only after a network host generated traffic to UDP port 2222. This results in the FiOS Router accepting the inbound traffic from the gaming server, and sending it back to the network host which originated the outgoing traffic to UDP port 2222.

To configure port triggering:

1. Select **Port Triggering** from the left side of any Security screen. The "Port Triggering" screen appears.

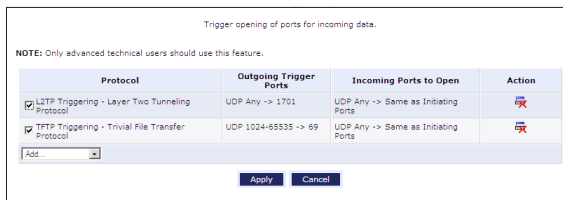

2. Select either "User Defined" or "Show All Services" from the drop-down list next to "Add."



3. If Show All Services is selected in step 2, select a Service from the list. The service is added to the Port Triggering screen as an active protocol.
4. If User Defined is selected in step 2, the “Edit Port Triggering Rule” screen appears. Enter a service name in the appropriate text box, then configure its inbound and outbound trigger ports by clicking the appropriate links.

## 6.7 Remote Administration

The FiOS Router can be accessed and controlled not only from within the local network, but also from the Internet using remote administration.

To access, select **Remote Administration** from the left side of any Security screen. The “Remote Administration” screen appears.

**Warning:** Enabling Remote Administration puts the FiOS Router’s network at risk from outside attacks.

**Remote Administration**

- Configure Remote Administration to the router

 **Attention**

With Remote Administration enabled, your network will be at risk from outside attacks.

<b>Allow Incoming WAN Access to the Telnet Server</b>
<input type="checkbox"/> Using Primary Telnet Port (23)
<input type="checkbox"/> Using Secondary Telnet Port (8023)
<input type="checkbox"/> Using Secure Telnet over SSL Port (992)
<b>Allow Incoming WAN Access to Web-Management</b>
<input type="checkbox"/> Using Primary HTTP Port (80)
<input type="checkbox"/> Using Secondary HTTP Port (8080)
<input type="checkbox"/> Using Primary HTTPS Port (443)
<input type="checkbox"/> Using Secondary HTTPS Port (8443)
<b>Diagnostic Tools</b>
<input checked="" type="checkbox"/> Allow Incoming WAN ICMP Echo Requests (e.g. pings and ICMP traceroute queries)
<input type="checkbox"/> Allow Incoming WAN UDP Traceroute Queries

## 6 Configuring Security Settings

### 6.7 Remote Administration

#### 6.7a Telnet

Telnet is used to create a command-line session and gain access to all system settings and parameters using a text-based terminal. Select the Telnet port to be used by clicking in the appropriate check box, then click **Apply**.

#### 6.7b Web Management

Web Management is used to obtain access to the FiOS Router's GUI and gain access to all settings and parameters, using a web browser. Both secure (HTTPS) and non-secure (HTTP) access is available. Select the port to be used by clicking in the appropriate text box, then click **Apply**.

**Note:** Telnet and Web Management remote administration access may be used to modify or disable firewall settings. Local IP addresses and other settings can also be changed, making it difficult or impossible to access the FiOS Router from the local network. Therefore, remote administration access to Telnet or Web Management services should be activated only when absolutely necessary.

#### 6.7c Diagnostic Tools

Diagnostic Tools are used for troubleshooting and remote system management by a user or the ISP.

**Note:** Encrypted remote administration is performed using a secure SSL connection, and requires an SSL certificate. When accessing the FiOS Router for the first time using encrypted remote administration, a warning appears regarding certificate authentication because the FiOS Router's SSL certificate is self-generated. When encountering this message under these circumstances, ignore it and continue. Even though this message appears, the self-generated certificate is safe and provides a secure SSL connection.

## 6.8 Static NAT

Static NAT allows devices behind a firewall and configured with private IP addresses appear to have public IP addresses on the Internet. This allows an internal host, such as a web server, to have an unregistered (private) IP address and still be accessible over the Internet. To configure static NAT:

1. Select **Static NAT** from any Security screen. The “Static NAT” screen appears.

Static NAT						
Static IP Mapping Table						
ID	Networked Computer / Device	Public IP Address	WAN Connection Type	Status	Port Forwarding	Action
Add						

2. Click **Add**. The “Add NAT/NAPT Rule” screen appears.

**Add NAT/NAPT Rule**

Local Host: Specify Address 192.168.1.0

Public IP Address: 0 . 0 . 0 . 0

WAN Connection Type: All Broadband Devices

Enable Port Forwarding For Static NAT

3. Select a source address from the “Specify Address” drop-down list in the “Local Host” row, or enter a IP address in the text box to the right.
4. Enter the public IP address in the “Public IP Address” text boxes.
5. Select the WAN connection type from the “WAN Connection Type” drop-down list.
6. If using port forwarding, activate the “Enable Port Forwarding...” check box, then select a protocol from the “Protocol” drop-down menu.

Repeat these steps to add more static IP addresses from the network.

# 6 Configuring Security Settings

## 6.9 Advanced Filtering

### 6.9 Advanced Filtering

Advanced filtering is designed to allow comprehensive control over the firewall's behavior. Specific input and output rules can be defined, the order of logically similar sets of rules controlled, and distinctions made between rules that apply to the Internet and rules that apply to local network devices.

To access, select **Advanced Filtering** from any Security screen. The "Advanced Filtering" screen appears.

**Advanced Filtering**

NOTE: Only advanced technical users should use this feature.

**Input Rule Sets:** Manage all incoming traffic from the Internet

Rule ID	Source Address	Destination Address	Match	Operation	Status	Action
Network (Home/Office) Rules						
Ethernet Rules						
Broadband Connection (Ethernet) Rules						
Coax Rules						
Broadband Connection (Coax) Rules						
Wireless Access Point Rules						
WAN PPPoE Rules						

**Output Rule Sets:** Manage all outbound traffic to the Internet

Rule ID	Source Address	Destination Address	Match	Operation	Status	Action
Network (Home/Office) Rules						
Ethernet Rules						
Broadband Connection (Ethernet) Rules						
Coax Rules						
Broadband Connection (Coax) Rules						
Wireless Access Point Rules						
WAN PPPoE Rules						

Apply Cancel Resolve Now Refresh

Two sets of rules can be configured: input rules and output rules. Following is a description of the set ordering for inbound and outbound packets.

## 6.9a Inbound/Outbound Packets - Rule Sets

There are numerous rules automatically inserted by the firewall to provide improved security and block harmful attacks. The pre-populated rules displayed are required for operation on the Verizon network.

To configure advanced filtering rules, click **Add** next to the rule title. The “Add Advanced Filter” screen appears.

To add an advanced filtering rule, define the following rule parameters:

### 6.9c Matching

To apply a firewall rule, a match must be made between IP addresses or ranges and ports. Use the “Source Address” and “Destination Address” drop-down lists to define the coupling of source and destination traffic. Port matching will be defined when selecting protocols. For example, if the FTP protocol is selected, port 21 will be checked for matching traffic flow between the defined source and destination IPs.

### 6.9d Operation

This is where the action the rule will take is defined. Select one of the following radio buttons:

- **Drop** - Deny access to packets that match the source and destination IP addresses and VCP reset to the origination peer.

## 6 Configuring Security Settings

### 6.9 Advanced Filtering

- **Accept** - Allow access to packets that match the source and destination IP addresses and protocol ports defined in upper section of the screen. The data transfer session will be handled using Stateful Packet Inspection (SPI).
- **Accept Packet** - Allow access to packets that match the source and destination IP addresses and protocol ports defined in upper section of the screen. The data transfer session will not be handled using Stateful Packet Inspection (SPI), so other packets that match this rule will not be automatically allowed access. This setting is useful when creating rules that allow broadcasting.

#### 6.9e Logging

Click in this check box to add entries relating to this rule to the security log.

#### 6.9f Scheduler (When should this rule occur?)

If advanced filtering needs to be active constantly, select **Always** from the “When should this rule occur?” drop-down list. If the rule will only be active at certain times, select **User Defined** and click **Add**. Then, add a schedule rule (for more details about schedule rules, see the “Advanced Settings” chapter of this manual)

## 6.10 Security Log

The security log displays a list of firewall-related events, including attempts to establish inbound and outbound connections, attempts to authenticate at an administrative interface (the FiOS Router’s GUI or Telnet terminal), firewall configuration, and system start-up.

To access the security log, select **Security Log** from any Security screen. The “Security Log” screen appears.

**Security Log**

Press the **Refresh** button to update the data.

Time	Event	Event-Type	Details
Dec 14 17:06:21 2007	System Log	Message	User authentication success success (Username: admin)
Dec 14 17:06:16 2007	System Log	Message	User authentication failure failure (Invalid password. Username: admin)
Dec 14 16:17:59 2007	System Log	Message	User authentication success success (Username: admin) {repeated 4 times, last time on Dec 14 17:06:35 2007}
Dec 14 16:18:28 2007	Firewall Setup	Configuration change	WBM user Unknown (0.0.0.0) has changed security settings
Dec 14 16:18:05 2007	Firewall Setup	Firewall status changed	enabled
Dec 14 16:18:03 2007	Firewall Setup	Configuration change	WBM user Unknown (0.0.0.0) has changed security settings
Dec 14 16:17:59 2007	System Log	Message	The system is UP!

### 6.10a Time

The time (based on the FiOS Router’s date and time settings) the event occurred.

### 6.10b Event

There are three kinds of events listed in the system log: **Firewall Info**, **Firewall Setup**, and **System Log**.

### 6.10c Event-Type

The “Details” column displays more information about the packet or the event, such as protocol, IP addresses, ports, etc. The following are the available event types that can be recorded in the security log:

- **802.1Q** - a 802.1Q (VLAN) packet has been accepted.
- **Access control** - a packet has been accepted/blocked because of an access control rule.

## 6 Configuring Security Settings

### 6.10 Security Log

- **Advanced Filter Rule** - a packet has been accepted/blocked because of an advanced filter rule.
- **ARP** - an ARP packet has been accepted.
- **AUTH:113 request** - an outbound packet for AUTH protocol has been accepted (for maximum security level).
- **Broadcast/Multicast protection** - a packet with a broadcast/multicast source IP has been blocked.
- **Connection closed** - debug message regarding connection.
- **Connection opened** - debug message regarding connection.
- **Default policy** - a packet has been accepted/blocked according to the default policy.
- **Defragmentation failed** - the fragment has been stored in memory and blocked until all fragments have arrived and defragmentation can be performed.
- **DHCP relay agent** - a DHCP relay packet has been received (depends on the distribution)
- **DHCP request** - the FiOS Router sent a DHCP request (depends on the distribution)
- **DHCP response** - the FiOS Router received a DHCP response (depends on the distribution)
- **DMZ network packet** - a packet from a demilitarized zone network has been blocked.
- **Echo/Chargen/Quote/Snork protection** - a packet has been blocked due to Echo/Chargen/Quote/Snork protection.
- **Error: No memory** - a new connection has not been established because of lack of memory.
- **Firewall internal** - from the firewall internal mechanism, in case this event-type is recorded, an accompanying explanation will be added.



- **Firewall rules were changed** - the firewall rule set has been modified.
- **Firewall status changed** - the firewall changed status from up to down or the vice versa, as specified in the event type description.
- **First packet in connection is not a SYN packet** - a packet has been blocked due to a TCP connection that started without a SYN packet.
- **Fragmented packet** - a fragment has been rejected.
- **Fragmented packet, bad align** - a packet has been blocked because, after defragmentation, the packet was badly aligned.
- **Fragmented packet, header too big** - a packet has been blocked because, after defragmentation, the header was too big.
- **Fragmented packet, header too small** - a packet has been blocked because, after defragmentation, the header was too small.
- **Fragmented packet, no memory** - a fragmented packet has been blocked because there is no memory for fragments.
- **Fragmented packet, overlapped** - a packet has been blocked because, after defragmentation, there were overlapping fragments.
- **Fragmented packet, packet exceeds** - a packet has been blocked because, after defragmentation, the packet exceeded.
- **Fragmented packet, packet too big** - a packet has been blocked because, after defragmentation, the packet was too big.
- **FTP port request to 3rd party is forbidden (Possible bounce attack)** - a packet has been blocked.
- **ICMP Flood Protection** - a packet has been blocked, stopping an ICMP (Internet Control Message Protocol) flood.
- **ICMP protection** - a broadcast ICMP message has been blocked.
- **ICMP redirect protection** - an ICMP redirected message has been blocked.
- **ICMP replay** - an ICMP replay message has been blocked.
- **IGMP packet** - an IGMP packet has been accepted.

## 6 Configuring Security Settings

### 6.10 Security Log

- **Illegal packet options** - the options field in the packet's header is either illegal or forbidden.
- **IP Version 6** - an IPv6 packet has been accepted.
- **IPv6 over IPv4** - an IPv6 over IPv4 packet has been accepted.
- **Malformed packet: Failed parsing** - a packet has been blocked because it is malformed.
- **Maximum security enabled service** - a packet has been accepted because it belongs to a permitted service in the maximum security level.
- **Multicast IGMP connection** - a multicast packet has been accepted.
- **NAT Error: Connection pool is full. No connection created** - a connection has not been created because the connection pool is full.
- **NAT Error: Conflict Mapping already exists** - a conflict occurred because the NAT mapping already exists, so NAT failed.
- **NAT Error: No free NAT IP** - no free NAT IP, so NAT has failed.
- **NAT out failed** - NAT failed for this packet.
- **Outbound Auth1X** - an outbound Auth1X packet has been accepted.
- **Packet invalid in connection** - an invalid connection packet has been blocked.
- **Parental control** - a packet has been blocked because of parental control.
- **Passive attack on ftp-server: Client attempted to open Server ports** - a packet has been blocked.
- **PPP Discover** - a PPP discover packet has been accepted.
- **PPP Session** - a PPP session packet has been accepted.
- **PPTP connection** - a packet inquiring whether the FiOS Router is ready to receive a PPTP connection has been accepted.
- **Remote administration** - a packet designated for the FiOS Router management has been accepted/blocked.

- **Router initiated traffic** - all traffic the FiOS Router initiates is recorded.
- **Service** - a packet has been accepted because of a certain service, as specified in the event type.
- **Spoofing protection** - a packet from the Internet with a source IP belonging to the local network has been blocked.
- **STP packet** - an STP (Spanning Tree Protocol) packet has been accepted/rejected.
- **SynCookies Protection** - a SynCookies packet has been blocked.
- **Trusted device** - a packet from a trusted device has been accepted.
- **UDP Flood Protection** - a packet has been blocked, stopping a UDP flood.
- **User authentication** - a message arrived during login time, including both successful and failed authentication.
- **Wildcard connection hooked** - debug message regarding connection.
- **Wildcard connection opened** - debug message regarding connection.
- **WinNuke protection** - a WinNuke attack has been blocked.

#### 6.10d Details

Displays a textual description of the event.

# 6 Configuring Security Settings

## 6.10 Security Log

### 6.10e Log Settings

The “Log Settings” screen allows the user to modify the types of events that appear in the FiOS Router’s Security Log. Note that these settings correspond to event logging, not to the events themselves (i.e., disabling an event log removes the event from the Security Log; the event itself will continue to occur).

To view or change the security log settings:

1. Click **Settings** in the Security Log screen. The “Security Log Settings” screen appears.

The screenshot shows the "Log Settings" configuration page. It is organized into several sections, each with a title and a list of events with checkboxes to enable or disable logging for them.

- Accepted Events**
  - Accepted Incoming Connections
  - Accepted Outgoing Connections
- Blocked Events**
  - All Blocked Connection Attempts
  - WinNuke
  - Defragmentation Error
  - Blocked Fragments
  - Syn Flood
  - Echo Charigen
  - Multicast/Broadcast
  - Spoofed Connection
  - Packet Illegal Options
  - UDP Flood
  - ICMP Replay
  - ICMP Redirect
  - ICMP Multicast
  - ICMP Flood
- Other Events**
  - Remote Administration Attempts
  - Connection States
- Log Buffer**
  - Prevent Log Overrun

At the bottom of the form are two buttons: "Apply" and "Cancel".

2. Select the type of activities that will generate a log message:
  - **Accepted Incoming Connections** - activating this check box generates a log message for each successful attempt to establish an inbound connection to the local network.
  - **Accepted Outgoing Connections** - activating this check box generates a log message for each successful attempt to establish an outgoing connection to the public network.

3. Select the type of blocked events to be listed in the log:
  - **All Blocked Connection Attempts** - activating this check box generates log messages for all blocked events.
  - **Other Blocked Events** - if "All Blocked Connection Attempts" is un-checked, select specific blocked events from this list to generate log messages.
4. Click in the "Remote Administration Attempts" check box to write a log message for each remote-administration connection attempt, whether successful or not.
5. Click in the "Connection States" check box to track connection handling by the firewall and Application Level Gateways (ALGs).
6. Click **Apply** to save changes.

# 7

- 7.0** Introduction
- 7.1** Activating Parental Controls
- 7.2** Rule Summary

# Using Parental Controls

The abundance of harmful information on the Internet poses a serious challenge for employers and parents alike: “How can I regulate what my employee or child does on the Internet?” With that question in mind, the FiOS Router’s Parental Controls were designed to allow control of Internet access on all locally networked devices.

# 7 Using Parental Controls

## 7.1 Activating Parental Controls

### 7.1 Activating Parental Controls

To create a basic access policy for a computer on the FiOS Router's network, click Parental Control from the top of the Home screen and follow these instructions:

1. The "Parental Control" screen appears. From the "Networked Computer/Device" list box, select a computer/device, then click **Add**. The computer/device appears in the "Selected Devices" list box.

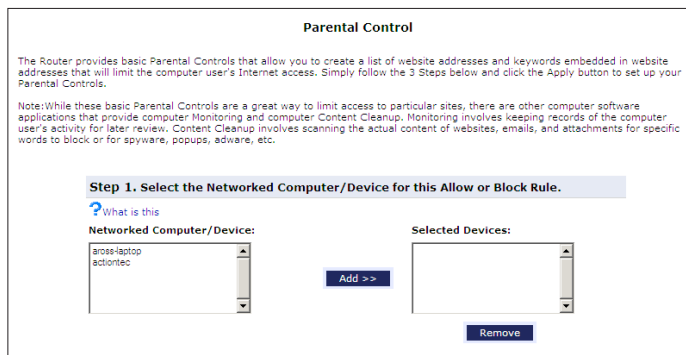

2. In the "Limit Access by" section, select one of the following options:
  - **Block the following Websites and Embedded Keywords within a Website** - blocks all websites or keywords (see step 3) from being accessed on the computers/devices selected in step 1.
  - **Allow the following Websites and Embedded Keywords within a Website** - allows access only to the websites or keywords (see step 3) on the computers/devices selected in step 1.
  - **Blocking ALL Internet Access** - blocks all Internet access on the computers/devices selected in step 1.

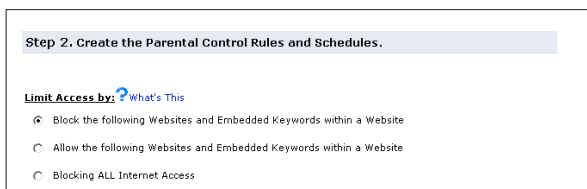



3. Enter the URL address of a website and, if applicable, the embedded keyword within the website. Click **Add**. The websites and/or keywords selected will appear in the textbox to the right. If you make a mistake, or wish to delete a previously entered website/keyword, select it, then click **Remove**.

The screenshot shows a web configuration interface. On the left, there are two input sections. The first is labeled "Website:" and has a text input field with the example "www.example.com" below it. The second is labeled "Embedded keyword within a Website:" and has a text input field with the example "sample" within www.sample.com" below it. To the right of these inputs is a large empty rectangular box with a vertical scrollbar on its right side. A blue button labeled "Add >>" is positioned between the input fields and the large box. A blue button labeled "Remove" is located at the bottom right of the entire interface area.

4. If needed, you can create a schedule for when you want the rule to be active, or inactive. In the "Create Schedule" section, select the affected days.

The screenshot shows the "Create Schedule" section. It starts with the text "Create Schedule: ? What's This" where the question mark is a blue link. Below this is the label "Days:". Underneath, there are seven radio button options for the days of the week: Monday, Tuesday, Wednesday, Thursday, Friday, Saturday, and Sunday. All radio buttons are currently unselected.

5. Select whether the rule will be active or inactive during the schedule you created by clicking the radio button next to the appropriate option.

The screenshot shows the "Times:" section. It contains two radio button options. The first option is selected and is labeled "Rule will be active at the scheduled time." The second option is unselected and is labeled "Rule will be inactive at the scheduled time."

# 7 Using Parental Controls

## 7.2 Rule Summary

- If you want more precise control over the schedule, set up an hourly schedule by entering the start and end times in the appropriate text boxes. Make sure to specify AM or PM.

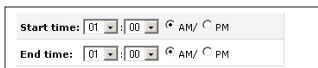

A screenshot of a time selection interface. It features two rows: "Start time:" and "End time:". Each row contains a dropdown menu for hours (set to 01), a dropdown menu for minutes (set to 00), and radio buttons for "AM" and "PM".

**Note:** The hourly schedule only affects the days selected in step 4. For example, if you select Saturday and Sunday, a start time of 10 a.m., and an end time of 3 p.m., the scheduled time will be Saturday/Sunday, 10 a.m. to 3 p.m.

- In the "Create Rule Name" section, enter a rule name and description in the appropriate text boxes.



A screenshot of the "Create Rule Name" section. It includes a link "What's This" with a question mark icon. Below the link is the instruction "Create your Rule Name and Description". There are two text input fields: "Rule Name:" and "Description:".

- Click **Apply** to save and apply the new rule.

## 7.2 Rule Summary

Clicking **Rule Summary** from the menu on the left side generates the "Rule Summary" screen.



A screenshot of the "Rule Summary" screen. It displays a table with the following columns: Rule Name, Description, Computer/Device, View Rule, Edit Rule, and Delete Rule. The first row contains the data: Basic, Basic protection, actiontec, a magnifying glass icon, a pencil icon, and a trash can icon.

Rule Name	Description	Computer/Device	View Rule	Edit Rule	Delete Rule
Basic	Basic protection	actiontec			

The Rule Summary screen displays a list of all rules created for the FiOS Router. Additionally, the rule can be viewed by clicking the magnifying glass in the "View Rule" column, or edited by clicking on the icon in the "Edit Rule" column.

# 8

- 8.0** Introduction
- 8.1** Using Advanced Settings
- 8.2** Utilities
- 8.3** DNS Settings
- 8.4** Network Settings
- 8.5** Configuration Settings
- 8.6** Time Settings
- 8.7** Firmware Upgrade
- 8.8** Routing Settings

# Configuring Advanced Settings

**The FiOS Router's Advanced Settings cover a wide range of sophisticated configurations available for the Router's firmware and network. Changes to any of the Advanced Settings could adversely affect the operation of the FiOS Router and the local network, and should be made with caution by experienced network technicians only.**

## 8.1 Using Advanced Settings

To access the FiOS Router's Advanced Settings, click **Advanced** at the top of the Home screen. Click **Yes** in the Warning screen, and the "Advanced" screen appears.

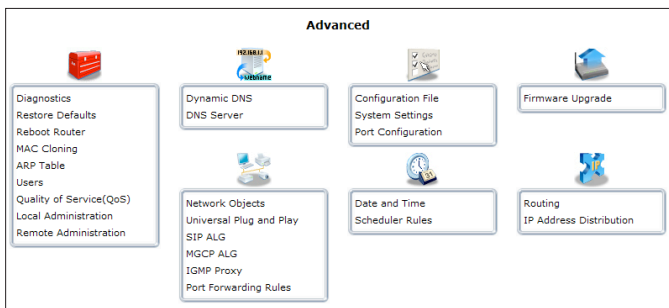

The following settings are explained in this chapter:

- **Diagnostics** - perform diagnostic tests on the FiOS Router
- **Restore Defaults** - reset the FiOS Router to its default settings
- **Reboot Router** - restart the FiOS Router
- **MAC Cloning** - clone MAC addresses
- **ARP Table** - display active devices and their IP and MAC addresses, etc.
- **Users** - create and manage remote users
- **Quality of Service (QoS)** - explained in Appendix A of this manual
- **Local Administration** - allows the user to grant local Telnet access
- **Remote Administration** - explained in chapter 4 of this manual
- **Dynamic DNS** - configure Dynamic DNS settings
- **DNS Server** - manage the local (LAN) network for host name and IP address

## **8** **Configuring Advanced Settings**

### **8.1 Using Advanced Settings**

- **Network Objects** - create and manage network objects (discrete LAN subsets)
- **Universal Plug and Play** - configure Universal Plug and Play settings
- **SIP ALG** - manage SIP ALG settings
- **MGCP ALG** - manage MGCP ALG settings
- **IGMP Proxy** - manage IGMP Proxy settings
- **Port Forwarding Rules** - manage and create open ports for various Internet protocols or customize an application
- **Configuration File** - manage configuration files
- **System Settings** - modify the FiOS Router's system settings
- **Port Configuration** - configure the FiOS Router's ports
- **Date and Time** - configure the FiOS Router's clock and calendar
- **Scheduler Rules** - schedule firewall activation
- **Firmware Upgrade** - download and install new versions of the FiOS Router's firmware
- **Routing** - manage routing policies
- **IP Address Distribution** - manage the IP addresses of devices on the network

## 8.2 Utilities

The first collection of Advanced Settings (beneath the Toolbox icon) are the Utilities settings.

### 8.2a Diagnostics

The Diagnostics screen can assist in testing network connectivity. This feature pings (ICMP echo) an IP address and displays the results, such as the number of packets transmitted and received, round trip time, and success status. To diagnose network connectivity:

1. Click **Diagnostics** from the Advanced screen. The “Diagnostics” screen appears.

**Diagnostics**

- Diagnostics can assist in testing network connectivity. This feature pings (ICMP echo) an IP address and displays the results, such as the number of packets transmitted and received, round trip time, and success status

**Ping (ICMP Echo)**

<b>Destination:</b>	<input type="text" value="192.168.1.2"/>	<b>Go</b>
<b>Number of pings:</b>	<input type="text" value="4"/>	
<b>Status:</b>	Test Failed	
<b>Packets:</b>	4/4 transmitted, 0/4 received, 100% loss	

Press the **Refresh** button to update the status.

**Close**   **Refresh**

2. Enter the IP address or domain name to be tested in the “Destination” field.
3. Click **Go**.
4. In a few seconds, diagnostics statistics will be displayed. If no new information is displayed, click **Refresh**.

### 8.2b Restore Defaults

If the FiOS Router's factory default settings need to be restored (to build a new network from the beginning, for example), use the following procedure:

1. Click **Restore Defaults** in the Advanced screen. The "Attention" screen appears.
2. If needed, click **Save Configuration File** to save the FiOS Router's current configuration to a file. The FiOS Router's current settings can then be reapplied after restoring default settings (see "Configuration File" in this chapter for more information).

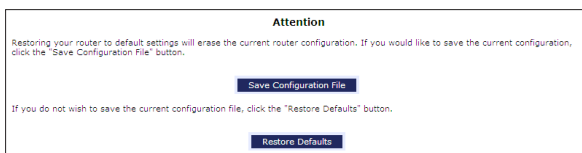

3. Click **Restore Defaults**. The FiOS Router will restart, and factory default settings will be applied

**Note:** All of the FiOS Router's settings and parameters will be restored to their default values after performing the Restore Default procedure. This includes the administrator password; a user-specified password will no longer be valid.

### 8.2c Reboot the FiOS Router

To reboot the FiOS Router:

1. Click **Restart** in the Advanced screen. The "Reboot Router" screen appears.



2. Click **OK** to restart the FiOS Router. This may take up to one minute.

To reenter the FiOS Router's GUI after restarting the FiOS Router, click the web browser's "Refresh" button.



## 8.2d MAC Cloning

A MAC (Media Access Control) address is a hexadecimal code that identifies a device on a network. All networkable devices have a unique MAC address. When replacing another network device with the FiOS Router, the installation process can be simplified by copying the MAC address of the existing computer to the FiOS Router. To do this:

1. Click **MAC Cloning** in the Advanced screen. The “MAC Cloning” screen appears.

**MAC Cloning**

- MAC Address Cloning provides the ability to emulate the routers MAC address to appear identical to the original hardware address. Use this feature only if your ISP requires MAC Address authentication.

Set MAC of Device: Broadband Connection (Ethernet) ▼

To Physical Address: 00 10 f1 b3 42 47 ca

[Clone My MAC Address](#)

[Apply](#)    [Cancel](#)

2. Enter the MAC address to be cloned in the “To Physical Address” text boxes.
3. Click **Clone My MAC Address** to capture the MAC address of the computer currently accessing the FiOS Router’s GUI. The FiOS Router will now have the new MAC address.

## 8.2e ARP (Address Resolution Protocol) Table

Clicking **ARP Table** in the Advanced screen generates the “ARP Table” screen. This screen displays the IP and MAC addresses of each DHCP connection.

**ARP Table**

- The ARP Table displays the IP and MAC addresses of each DHCP connection.

IP Address	MAC Address	Device	DHCP ACL
192.168.1.2	00:90:27:b3:ce:49	Network (Home/Office)	Add

[Close](#)    [Refresh](#)

### 8.2f Users

To manage individual users:

1. Click **Users** in the Advanced screen, which generates the “Users” screen.

**Users**

- The Users page provides the ability to add or edit Admin or Guest access to the router.

Full Name	User Name	Permissions	Action
Administrator	admin	Administrator	
<b>New User</b>			

**Close**

2. Click **New User**, which generates the “User Settings” screen.

**User Settings**

**General**

Full Name:

User Name (case sensitive):

New Password:

Retype New Password:

Permissions: Administrator ▾

**E-Mail Notification**

[Click here to configure notification Mail Server](#)

Notification Address:

System Notify Level: None ▾

Security Notify Level: None ▾

**Apply** **Cancel**

3. Specify the following parameters in the “General” section of the screen:
  - **Full Name** - The user’s full name.
  - **User Name** - The name a remote user will use to access the home or office network. This entry is case-sensitive.
  - **New Password/Retype New Password** - The password for the user (enter again to confirm).
  - **Permissions** - The level of access the user is allowed. Options include **Administrator** or **Limited**.

4. **E-mail Notification** - Email notification can be used to receive indications of system events for a predefined severity classification. The available types of events are "System" or "Security" events. The available severity of events are **Error**, **Warning**, and **Information**. To configure email notification for a specific user:
  5. Make sure an outgoing mail server has been configured in "System Settings". If not, click [Click Here to Configure Notification Mail Server](#) to configure the outgoing mail server.
  6. Enter the user's email address in the "Notification Address" text box.
  7. Select the "System" and "Security" notification levels in the "System Notify Level" and "Security Notify Level" drop-down lists.

**Note:** Changing any of the user parameters will prompt the connection associated with the user to terminate. For changes to take effect, activate the connection manually after modifying user parameters.

## 8.2g Quality of Service

The FiOS Router's QoS (Quality of Service) capabilities are covered in detail in appendix A of this manual.

### 8.2h Local Administration

Clicking **Local Administration** in the Advanced screen generates the “Local Administration” screen. This screen allows the user to grant local Telnet access using a particular Telnet port.

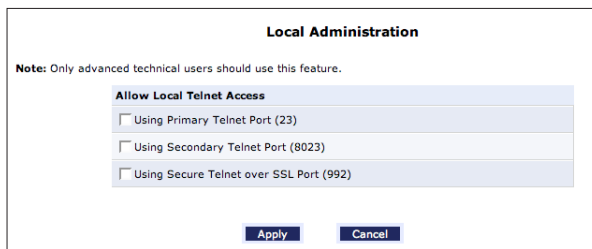

The screenshot shows a web interface titled "Local Administration". Below the title is a note: "Note: Only advanced technical users should use this feature." Underneath is a section titled "Allow Local Telnet Access" containing three rows, each with a checkbox and a label: "Using Primary Telnet Port (23)", "Using Secondary Telnet Port (8023)", and "Using Secure Telnet over SSL Port (992)". At the bottom of the form are two buttons: "Apply" and "Cancel".

To use, select a Telnet port by clicking in the appropriate check box, then click **Apply**.

### 8.2i Remote Administration

The FiOS Router’s Remote Administration capabilities are covered in detail in the chapter 6 of this manual.

## 8.3 DNS Settings

The second section of the Advanced window is the DNS (Domain Name System) settings section, which includes “Dynamic DNS” and “DNS Server”

### 8.3a Dynamic DNS

Dynamic DNS creates a dynamic IP address that is aliased to a static hostname, allowing a computer on the network to be more easily accessible from the Internet. Typically, when connecting to the Internet, the service provider assigns an unused IP address from a pool of IP addresses, and this address is used only for the duration of a specific connection. Dynamically assigning addresses extends the usable pool of available IP addresses, while maintaining a constant domain name. This allows the user to access a device (a camera, for example) from a remote location, since the device will always have the same IP address.

When using Dynamic DNS, each time the IP address provided by the ISP changes, the DNS database changes accordingly to reflect the change. In this way, even though the IP address of the computer changes often, its domain name remains constant and accessible.

### Setting up Dynamic DNS

To set up Dynamic DNS on the FiOS Router, click **Dynamic DNS** in the Advanced screen. When the “Dynamic DNS” screen appears, click **New Dynamic DNS Entry**.

**Dynamic DNS**

- Setup Dynamic DNS (Domain Name Server)
- Dynamic DNS is a dynamic IP address to be aliased to a static hostname, allowing a computer on the network to be more easily accessible from the Internet

Host Name	Status	Provider	User Name	Dynamic DNS System	Action
<a href="#">New Dynamic DNS Entry</a>					

Press the **Refresh** button to update the status.

## 8 Configuring Advanced Settings

### 8.3 DNS Settings

Another Dynamic DNS screen appears.

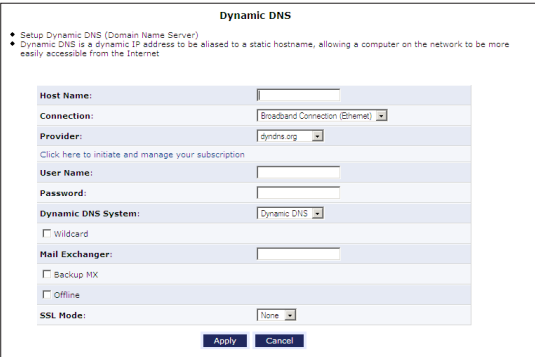

The screenshot shows a web form titled "Dynamic DNS". At the top, there are two bullet points: "• Setup Dynamic DNS (Domain Name Server)" and "• Dynamic DNS is a dynamic IP address to be aliased to a static hostname, allowing a computer on the network to be more easily accessible from the Internet". The form contains several fields: "Host Name" (text input), "Connection" (dropdown menu with "Broadband Connection (Ethernet)" selected), "Provider" (dropdown menu with "dyndns.org" selected), "User Name" (text input), "Password" (text input), "Dynamic DNS System" (dropdown menu with "Dynamic DNS" selected), "Mail Exchanger" (text input), "Backup MX" (checkbox), "Offline" (checkbox), and "SSL Mode" (dropdown menu with "None" selected). At the bottom right, there are "Apply" and "Cancel" buttons.

Configure the following parameters:

#### Host Name

Enter the full Dynamic DNS domain in this text box.

#### Connection

Select the connection with which to couple the Dynamic DNS service. Options include **Broadband Connection (Ethernet)**, **Broadband Connection (Coax)**, and **WAN PPPoE**.

#### Provider

Select the FiOS Router's Dynamic DNS account provider from the drop-down list.

#### User Name

Enter the Dynamic DNS user name in this text box.

#### Password

Enter the Dynamic DNS password in this text box.

## Dynamic DNS System

Select one of the options from the drop-down list.

## Wildcard

Select the "Wildcard" check box to allow any URL that includes the domain name ("here.yourhost.dyndns.org," for example) to connect.

## Mail Exchanger

Enter the mail exchange server address. This will redirect all emails arriving at the Dynamic DNS address to the mail server.

## Backup MX

Select this check box to designate the mail exchange server to be a backup server.

## Offline

Disable the Dynamic DNS feature by clicking this check box. This feature is available only to users who have purchased some type of upgrade credit from the Dynamic DNS provider. Note that changing the redirection URL can only be performed via the Dynamic DNS provider's website.

## SSL Mode

If the Dynamic DNS service chosen supports SSL, select the SSL mode from the drop-down menu (options: **None**, **Chain**, **Direct**).

To edit the host name or IP address of an entry:

1. Click the appropriate "Edit" icon in the Action column. The "DNS Entry" screen appears.

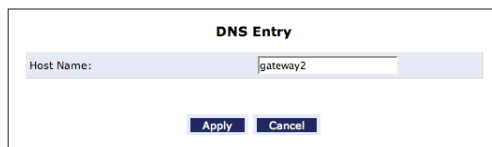

The screenshot shows a form titled "DNS Entry". It contains a text input field labeled "Host Name:" with the value "gateway2" entered. Below the input field are two buttons: "Apply" and "Cancel".

## **8** **Configuring Advanced Settings**

### **8.3 DNS Settings**

2. If the host was manually added to the DNS Table, its host name and/or IP address can be modified. Otherwise, only modify its host name.
3. Click **Apply** to save the changes.

To remove a host from the DNS table, click the appropriate “Delete” icon in the Action column. The entry will be removed from the table.

#### **8.3b DNS Server**

The Domain Name System (DNS) translates domain names into IP addresses, and vice versa. The FiOS Router’s DNS server is an auto-learning DNS, which means that when a new computer is connected to the network, the DNS server learns its name and automatically adds it to the DNS table. Other network users can immediately communicate with this computer using either its name or its IP address.

The FiOS Router’s DNS also provides the following services:

- shares a common database of domain names and IP addresses with the DHCP server;
- supports multiple subnets within the local network simultaneously;
- automatically appends a domain name to unqualified names;
- allows new domain names to be added to the database using the FiOS Router’s GUI;
- permits a computer to have multiple host names;
- and permits a host name to have multiple IPs (needed if a host has multiple network cards).

The DNS server does not require configuration. However, the list of computers known by the DNS can be viewed or a new computer can be added to the list.





## DNS Table

To view the list of computers stored in the DNS table, click **DNS Server** in the Advanced screen. The “DNS Server” screen appears.

**DNS Server**

- Add, edit or delete computers known by the routers DNS Server.

Host Name	IP Address	Source	Action
gateway2	192.168.1.2	DHCP	 
<a href="#" style="color: red; text-decoration: none;">Add DNS Entry</a>			

To add a new entry to the list:

1. Click **Add DNS Entry** in the DNS Server screen. The “DNS Entry” screen appears.

**DNS Entry**

Host Name:	<input style="width: 90%;" type="text" value="new-host"/>
IP Address:	<input style="width: 25%;" type="text" value="0"/> <input style="width: 25%;" type="text" value="0"/> <input style="width: 25%;" type="text" value="0"/> <input style="width: 25%;" type="text" value="0"/>

2. Enter the computer’s host name in the “Host Name” text box.
3. Enter the computer’s IP address in the “IP Address” text boxes.
4. Click **Apply** to save the changes.

### 8.4 Network Settings

The Network Settings section of the Advanced screen includes settings that affect the FiOS Router's network.

#### 8.4a Network Objects

Network objects is used to define a part of the FiOS Router's network (a group of computers, for example) by MAC addresses, IP addresses, and/or host names. The defined part becomes a "network object," and settings, such as configuring system rules, can be applied to all devices defined as part of the network object at once. For example, instead of setting the same website filtering configuration to five computers one at a time, the computers can be defined as a network object, and website filtering configuration can then be applied to all the computers simultaneously.

Network objects can be used to apply security rules based on host names instead of IP addresses. This may be useful, since IP addresses change from time to time. Moreover, it is possible to define network objects according to MAC addresses, making rule application more persistent against network configuration settings. To define a network object:

1. Click **Network Objects** in the Advanced screen. The "Network Objects" screen appears.

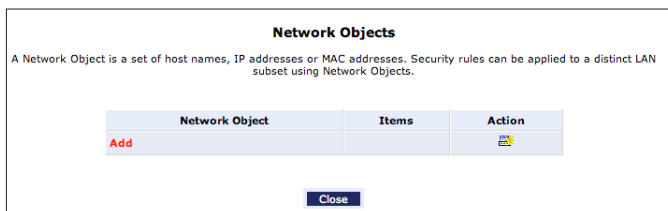

2. Click **Add**. The “Edit Network Object” screen appears.

**Edit Network Object**

**Network Object**

Description:

**Items**

Item	Action
Add	

3. Specify a name for the network object in the “Description” text box.
4. Click **Add**. The “Edit Item” screen appears.

**Edit Item**

Network Object Type:

IP Address:

5. Select the type of network object type from the “Network Object Type” list box. Options include **IP address**, **IP Subnet**, **IP Range**, **MAC Address**, **Host Name**, and **DHCP Option**.
6. Repeat to create other network objects, if needed. When finished, click **Apply** to save all created network objects.

### 8.4b Universal Plug and Play (UPnP)

To access the UPnP settings, perform the following:

1. Click **Universal Plug and Play** in the Advanced screen. The “Universal Plug and Play” settings screen appears.

**Universal Plug and Play**

- Universal Plug and Play provides the ability for the router to have new UPnP supported devices connected without having to reconfigure or reboot the router.

Allow Other Network Users to Control Wireless Broadband Router's Network Features

Enable Automatic Cleanup of Old Unused UPnP Services

WAN Connection Publication: Publish Only the Main WAN Connection

Apply Cancel

2. Click in the “Allow Other Network Users to Control Wireless Broadband FiOS Router’s Network Features” check box to enable UPnP and allow UPnP services to be defined on any of the network hosts.
3. Click in the “Enable Automatic Cleanup of Old Unused UPnP Services” check box to enable automatic cleanup of invalid rules. When enabled, this feature checks validity of all the UPnP services and rules every five minutes. Any old and unused UPnP defined service is removed, unless a user defined rule depends on it. Since there is a maximum limitation on the number of UPnP defined services (256), enable the cleanup feature if the limit is in danger of being exceeded.
4. Select whether all WAN connections, or only the main WAN connection, will have UPnP active, from the “WAN Connection Publication” drop-down list.

UPnP services are not deleted when disconnecting a computer without proper shutdown of the UPnP application (e.g., messenger). Thus, services may often not be deleted. This will eventually lead to exhaustion of rules and services, and no new services can be defined. In this scenario, the cleanup feature will find the invalid services and remove them, preventing services exhaustion.

### 8.4c SIP ALG

This screen allows the user to enable/disable SIP ALG. It is disabled by default. Do not enable this option unless instructed to do so by the ISP.

**SIP ALG**

Please note that Only advanced users should use this option to enable or disable SIP ALG.

Enable     Disable

### 8.4d MGCP ALG

This screen allows the user to enable/disable MGCP ALG. It is disabled by default. Do not enable this option unless instructed to do so by the ISP.

**MGCP ALG**

Please note that Only advanced users should use this option to enable or disable MGCP ALG.

Enable     Disable

## 8 Configuring Advanced Settings

### 8.4 Network Settings

#### 8.4e IGMP (Internet Group Management Protocol) Proxy

This screen allows the user to configure various IGMP proxy settings. For more information about the FiOS Router's IGMP multicast capabilities, see "IGMP Multicasting" in section 8.8 ("Routing Settings") of this manual.



The screenshot shows the "IGMP Proxy" configuration page. On the left is a navigation menu with options: Main, IGMP Proxy (selected), Interface Multicast Filtering, Host Multicast Filtering, ACL Multicast Filtering, Service Multicast Filtering, and Logout. The main content area is titled "IGMP Proxy" and contains the following settings:

IGMP Proxy	
IGMP Proxy (Enable/Disable):	Disabled ▾
Querier Configuration	
IGMP Version:	IGMPv3 ▾
Fast Leave:	Enabled ▾
Robustness (>= 1):	3
Query Interval (>= 1 second):	125
Query Response Interval (>= 1 second):	10
Client (Host) Configuration	
Unsolicited Report Interval (1 to 25 seconds):	1
Persistent Join Interval (1 to 25 seconds):	1
[Apply] [Cancel]	

#### IGMP Proxy (Enable/Disable)

Activate or deactivate IGMP Proxy by clicking on the down arrow and selecting **Enabled** or **Disabled**.

#### IGMP Version

Select the IGMP Proxy version by clicking on the down arrow and selecting **IGMPv1**, **IGMPv2**, or **IGMPv3**.

#### Fast Leave

Activate or deactivate Fast Leave by clicking on the down arrow and selecting **Enabled** or **Disabled**.

#### Robustness

Robustness refers to the level of susceptibility the subnet is to lost packets. Select the level of robustness by entering a number greater than or equal to 1.

### IGMP Proxy (Enable/Disable)

Activate or deactivate IGMP Proxy by clicking on the down arrow and selecting **Enable** or **Disabled**.

### Query Interval

The Query Interval is the amount of time between IGMP general query settings sent by the FiOS Router. The entered time period (in seconds) must be greater than or equal to 1.

### Query Response Interval

The Query Response Interval is the maximum amount of time the FiOS Router waits to receive a response to a general query message. The entered time period (in seconds) must be greater than or equal to 1.

### Unsolicited Report Interval

Set the unsolicited report interval here. The entered time period (in seconds) must be between 1 and 25.

### Persistent Join Interval

Set the persistent join interval here. The entered time period (in seconds) must be between 1 and 25.

## 8 Configuring Advanced Settings

### 8.4 Network Settings

#### Interface Multicast Filtering

Clicking **Interface Multicast Filtering** from the menu on the left side of any IGMP Proxy screen generates the Interface Multicast Filtering screen. Set the Interface Multicast Filtering options for each listed interface (Ethernet, Coax, and Wireless Access Point). When finished, click **Apply**.

Interface Multicast Filtering	
Interface Description	IGMP Allowed
Ethernet	<input checked="" type="checkbox"/>
Coax	<input checked="" type="checkbox"/>
Wireless Access Point	<input checked="" type="checkbox"/>

#### Host Multicast Filtering

Clicking **Host Multicast Filtering** from the menu on the left side of any IGMP Proxy screen generates the Host Multicast Filtering screen. Set the Host Multicast Filtering options here. Clicking on the Action icon generates another screen in which the host entry options can be entered. When finished, click **Apply**.

Host Multicast Filtering				
Host IP Address	STB	IGMP Allowed	Max Channel Allowed	Action
192.168.1.2	X	X	0	



### ACL Multicast Filtering

Clicking **ACL Multicast Filtering** from the menu on the left side of any IGMP Proxy screen generates the ACL Multicast Filtering screen. Set the ACL Multicast Filtering options in this screen, including activating whitelists and/or blacklists. Clicking **Add** generates a new screen in which additional addresses can be added to the list(s). When finished, click **Apply**.

**ACL Multicast Filtering**

Whitelist Enabled

Blacklist Enabled

**WhiteList Access Control List**

Multicast Address	Subnet Mask	Action
Add		

**BlackList Access Control List**

Multicast Address	Subnet Mask	Action
Add		

### Service Multicast Filtering

Clicking **Service Multicast Filtering** from the menu on the left side of any IGMP Proxy screen generates the Service Multicast Filtering screen. When finished, click **Apply**.

**Service Multicast Filtering**

Service	Multicast Address Range	Max STBs Allowed	Max Non-STBs Allowed	Action
Add				

## 8 Configuring Advanced Settings

### 8.4 Network Settings

Clicking **Add** generates the Multicast Service screen, in which additional services can be added, maximum STBs and non-STBs can be set, and new multicast addresses can be created (by clicking **Add**). When finished, click **Apply**.

**Multicast Service**

Service:

Max STBs Allowed:

Max Non-STBs Allowed:

**Multicast Address Range**

Multicast Address	Subnet Mask
<b>Add</b>	

### 8.5e Port Forwarding Rules

Port forwarding rules include a list of preset and user-defined applications and common port settings. These rules can be used in various security features, such as Access Control and Port Forwarding. New rules can be added to support new applications or existing ones can be edited when needed. Additionally, clicking **Advanced** on the bottom of the “Port Forwarding Rules” screen reveals a list of preconfigured protocols that can be activated with a single click. To define a port forwarding rule:

1. Click **Port Forwarding Rules** in the Advanced screen. The “Port Forwarding Rules” screen appears.

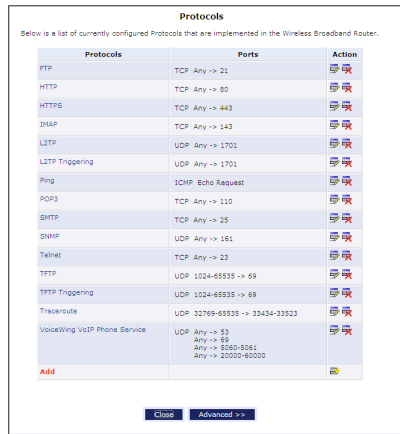

2. Click **Add** at the bottom of the screen. The “Edit Service” screen appears.

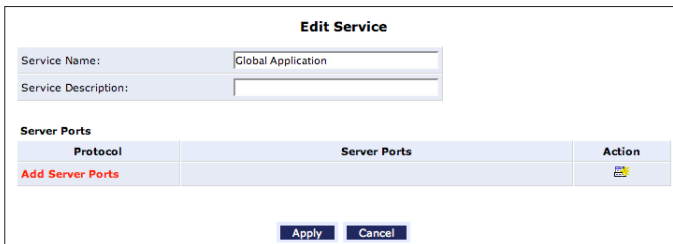

## 8 Configuring Advanced Settings

### 8.4 Network Settings

3. Name the service in the “Service Name” text box and, if needed, enter a description of the service in the “Service Description” text box, then click **Add Service Ports**. The “Edit Service Server Ports” screen appears.

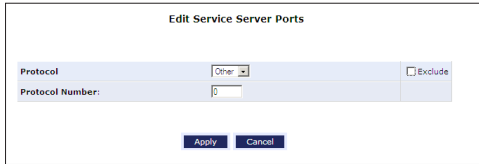

The screenshot shows a dialog box titled "Edit Service Server Ports". It contains two rows of input fields. The first row has a "Protocol" label, a dropdown menu with "Other" selected, and an "Exclude" checkbox. The second row has a "Protocol Number:" label and a text input field containing the number "8". At the bottom of the dialog are two buttons: "Apply" and "Cancel".

4. Select a protocol from the “Protocol” drop-down list. To create a new protocol, select “Other.” After selecting a protocol, the screen will refresh, displaying the relevant text boxes needed to edit the particular protocol.
5. Click **Apply** to save the changes.

## 8.5 Configuration Settings

This section includes settings that affect the FiOS Router's configuration.

### 8.5a Configuration File

Use the FiOS Router's Configuration File feature to view, save, and load configuration files, which are used to backup and restore the FiOS Router's current configuration. To do this:

1. Click **Configuration File** in the Advanced screen. The "Configuration File" screen appears.

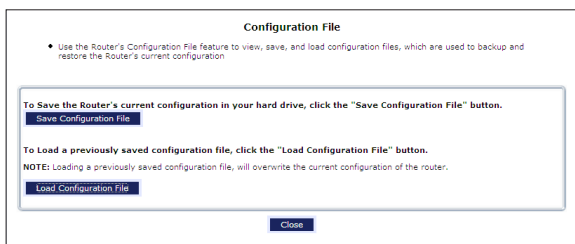

2. Click **Load Configuration File** to load the previous configuration from a file and restart the FiOS Router. Only configuration files saved on a particular FiOS Router can be applied to the FiOS Router; configuration files cannot be transferred between FiOS Routers.
3. Click **Save Configuration File** to backup the current configuration to a file.

**WARNING!** Manually editing a configuration file can cause the FiOS Router to malfunction or become completely inoperable.

# 8 Configuring Advanced Settings

## 8.5 Configuration Settings

### 8.5b System Settings

Clicking **System Settings** in the Advanced screen generates the “System Settings” screen, where various system and management parameters can be configured.

System Settings	
<b>Router Status</b>	
Wireless Broadband Router's Hostname:	<input type="text" value="Wireless_Broadband_R"/>
Local Domain:	<input type="text" value="home"/>
<b>Wireless Broadband Router</b>	
<input type="checkbox"/> Automatic Refresh of System Monitoring Web Pages	
<input checked="" type="checkbox"/> Prompt for Password When Accessing via LAN	
<input checked="" type="checkbox"/> Warn User Before Configuration Changes	
Session Lifetime:	<input type="text" value="600"/> Seconds
Configure number of concurrent users that can be logged into the router:	<input type="text" value="5"/>
<b>Remote Administration</b>	
<b>Management Application Ports</b>	
Primary HTTP Management Port:	<input type="text" value="80"/>
Secondary HTTP Management Port:	<input type="text" value="8080"/>
Primary HTTPS Management Port:	<input type="text" value="443"/>
Secondary HTTPS Management Port:	<input type="text" value="8443"/>
Primary Telnet Port:	<input type="text" value="23"/>
Secondary Telnet Port:	<input type="text" value="8023"/>
Secure Telnet over SSL Port:	<input type="text" value="892"/>
<b>Management Application SSL Authentication Options</b>	
Primary HTTPS Management Client Authentication:	<input type="text" value="None"/>
Secondary HTTPS Management Client Authentication:	<input type="text" value="None"/>
Secure Telnet over SSL Client Authentication:	<input type="text" value="None"/>
<b>System Logging</b>	
<input checked="" type="checkbox"/> Low Capacity Notification Enabled	
Allowed Capacity Before Email Notification:	<input type="text" value="80"/> %
System Log Buffer Size:	<input type="text" value="16"/> KB
Remote System Notify Level:	<input type="text" value="None"/>
<b>Security Logging</b>	
<input checked="" type="checkbox"/> Low Capacity Notification Enabled	
Allowed Capacity Before Email Notification:	<input type="text" value="80"/> %
Security Log Buffer Size:	<input type="text" value="16"/> KB
Remote Security Notify Level:	<input type="text" value="None"/>
<b>Outgoing Mail Server</b>	
Server:	<input type="text"/>
From Email Address:	<input type="text"/>
Port:	<input type="text" value="25"/>
<input type="checkbox"/> Server Requires Authentication	
<b>Auto WAN Detection</b>	
<input checked="" type="checkbox"/> Enabled	
PPP Timeout:	<input type="text" value="30"/> Seconds
DHCP Timeout:	<input type="text" value="30"/> Seconds
Number of Cycles:	<input type="text" value="2"/>
<input checked="" type="checkbox"/> Auto Detection Continuous Trying	
<input type="button" value="Apply"/> <input type="button" value="Cancel"/>	

## System

Use the “System” section of this screen to configure the following two options:

**Wireless Broadband Router’s Hostname** - Specify the FiOS Router’s host name by entering it into the this text box. The host name is also the FiOS Router’s URL address, so it can be entered here, rather than entering 192.168.1.1.

**Local Domain** - Specify the network’s local domain by entering it into this text box.

## Wireless Broadband Router

Use this section to configure the following:

**Automatic Refresh of System Monitoring Web Page** - Click in this check box to activate the automatic refresh of system monitoring web pages.

**Prompt for Password When Accessing via LAN** - Click in this check box to cause the FiOS Router to ask for a password when trying to connect to the network.

**Warn User Before Network Configuration Changes** - Click in this check box to activate user warnings before network configuration changes take effect.

**Session Lifetime** - After the FiOS Router has been inactive for a period of time, the user must reenter a user name and password to continue accessing the GUI. To change the length of this time period, enter the amount of time (in seconds) in the “Session Lifetime” text box.

**Configure a number of concurrent users...** - Used to limit the number of users that can access the FiOS Router at the same time. Select the number of users from the drop-down list.

#### Management Application Ports

This section allows the following management application ports to have their default port numbers to be changed:

- primary/secondary HTTP ports
- primary/secondary HTTPS ports
- primary/secondary Telnet ports
- secure Telnet over SSL ports

#### Management Application SSL Authentication Options

This section allows the user to access the FiOS Router's GUI through a browser or Telnet as a secure socket layer (SSL) session.

#### System Logging

Use this section to configure the following system log options.

**Enable Logging** - Click in this check box to activate system logging.

**Low Capacity Notification Enabled** - Click in this check box to activate low capacity notification (works in tandem with "Allowed Capacity Before Email Notification" and "System Log Buffer Size" options).

**Allowed Capacity Before Email Notification** - Enter the percentage of system log buffer capacity reached to trigger an email notification.

**System Log Buffer Size** - Enter the size of the system log buffer in this text box.

**Remote System Notify Level** - This feature is used to specify the type of information received for remote system logging. Options include **None**, **Error**, **Warning**, and **Information**.



## Security Logging

Use this section to configure the following security log options.

**Low Capacity Notification Enabled** - Click in this check box to activate low capacity notification (works in tandem with "Allowed Capacity Before Email Notification" and "Security Log Buffer Size" options).

**Allowed Capacity Before Email Notification** - Enter the percentage of security log buffer capacity reached to trigger an email notification.

**Security Log Buffer Size** - Enter the size of the security log buffer in this text box.

**Remote Security Notify Level** - This feature is used to specify the type of information received for security logging. Options include **None**, **Error**, **Warning**, and **Information**.

## Outgoing Mail Server

Use this section to configure the outgoing mail server options. This server is used to format and send system and security log email notifications.

**Server** - Enter the host name of the outgoing (SMTP) server in this text box.

**From Email Address** - Email notifications require a "from" address. Enter a "from" email address in this text box.

**Port** - Enter the port number of the email server in this text box.

**Server Requires Authentication** - If the email server requires authentication, click in this check box, then enter a user name and password in the "User Name" and "Password" text boxes that appear.

## 8 Configuring Advanced Settings

### 8.5 Configuration Settings

#### Auto WAN Detection

When activated, Auto WAN Detection causes the FiOS Router to automatically search for a WAN connection.

**Enable Logging** - Clicking in this check box activates automatic WAN detection.

**PPP Timeout** - Enter the amount of time (in seconds) before the FiOS Router stops attempting to establish a broadband PPP connection.

**DHCP Timeout** - Enter the amount of time (in seconds) before the FiOS Router stops attempting to establish a broadband DHCP connection.

**Number of Cycles** - Enter the number of times the FiOS Router attempts to detect a broadband PPP and DHCP connection.

**Auto Detection Continuous Trying** - Click in this check box to cause the FiOS Router to indefinitely search for a broadband connection.

#### 8.5c Ethernet Port Configuration

Ethernet port configuration allows the user to set up the FiOS Router's Ethernet ports as either full- or half-duplex ports, at either 10 Mbps or 100 Mbps. Selecting the "Auto" option causes the port to emulate the speed and duplex configuration of the port with which it is communicating.

Ethernet Port Configuration			
Port	Speed & Duplex		Status
WAN Port	Auto	▼	Disconnected
LAN Port 1	100 Full-Duplex	Auto	Connected
LAN Port 2	Auto	▼	Disconnected
LAN Port 3	Auto	▼	Disconnected
LAN Port 4	Auto	▼	Disconnected

## 8.6 Time Settings

The Time settings section of the Advanced window features utilities that involve times, dates and schedules.

### 8.6a Date and Time

To configure date, time, and daylight saving settings, perform the following:

1. Click **Date and Time** in the Advanced screen. The “Date and Time” screen appears.

**Date and Time**

**Localization**

Local Time: Dec 14, 2007 17:56:26

Time Zone: Pacific Time (GMT-08:00)

**Daylight Saving Time**

Enabled

Start: May 11 00 : 00

End: Nov 11 01 : 00

Offset: 60 Minutes

**Automatic Time Update**

Enabled

Protocol:  Time Of Day (TOD)  Network Time Protocol (NTP)

Update Every: 24 Hours [Sync Now](#)

Time Server	Action
ntp.actiontec.com	
<a href="#">Add</a>	

Status: Waiting for response from server

Press the **Refresh** button to update the status.

[Apply](#) [Cancel](#) [Clock Set](#) [Refresh](#)

2. Select the local time zone from the drop-down list. The FiOS Router can automatically detect daylight saving setting for selected time zones. If the daylight saving settings for a time zone are not automatically detected, the following four fields will be displayed:
  - **Enabled** - Select this check box to enable daylight saving time.
  - **Start** - Date and time when daylight saving starts.
  - **End** - Date and time when daylight saving ends.
  - **Offset** - The amount of time daylight saving time changes.

## 8 Configuring Advanced Settings

### 8.6 Time Settings

To perform an automatic time update:

1. Click in the “Enabled” check box in the “Automatic Time Update” section.
2. Select the protocol to be used to perform the time update by selecting either the “Time of Day” or “Network Time Protocol” radio button.
3. Specify how often to perform the update in the “Update Every” text box.
4. Define time server addresses by clicking **Add** on the bottom of the “Automatic Time Update” section and entering the IP address or domain name of the time server in the “Time Server Settings” screen.

#### 8.6c Clock Set

Click on this button at the bottom of the Date and Time screen (which generates the figure, below) to set the FiOS Router’s time and date.

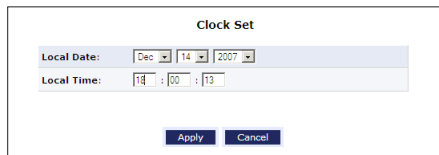

The image shows a 'Clock Set' dialog box with the following fields and buttons:

Clock Set		
Local Date:	Dec	14 2007
Local Time:	14	: 00 : 13
<input type="button" value="Apply"/> <input type="button" value="Cancel"/>		

### 8.6b Scheduler Rules

Scheduler rules are used for limiting the activation of firewall rules to specific time periods, either for days of the week, or for hours of each day. To define a rule:

1. Make sure the FiOS Router’s date and time are set correctly. To do this, see the “Date and Time” section in this chapter.
2. Click **Scheduler Rules** in the Advanced screen. The “Scheduler Rules” screen appears.

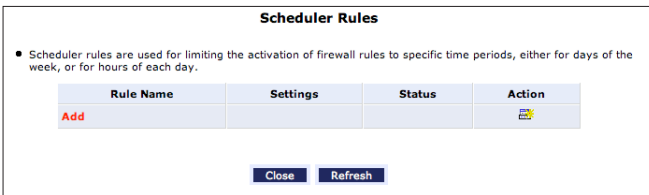

3. Click **Add**. The “Set Rule Schedule” screen appears.

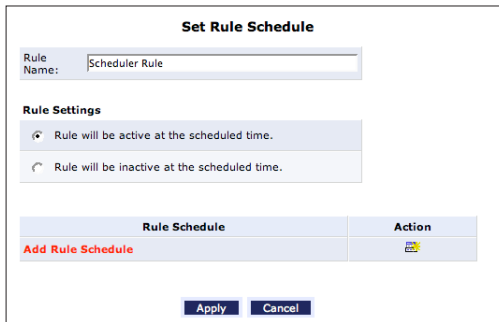

4. Enter a name for the rule in the “Rule Name” text box.
5. Specify if the rule will be active or inactive during the designated time period by clicking the appropriate “Rule Settings” radio button.

## 8 Configuring Advanced Settings

### 8.6 Time Settings

6. Click **Add Rule Schedule**. The “Edit Rule Schedule” screen appears.

**Edit Rule Schedule**

**Days of Week**

<input type="checkbox"/>	Monday
<input type="checkbox"/>	Tuesday
<input type="checkbox"/>	Wednesday
<input type="checkbox"/>	Thursday
<input type="checkbox"/>	Friday
<input type="checkbox"/>	Saturday
<input type="checkbox"/>	Sunday

**Hours Range**

Start	End	Action
<a href="#">New Hours Range Entry</a>		

7. Select or active or inactive days of the week by clicking in the appropriate text boxes.
8. If applicable, click **New Hours Range Entry** to define an active/inactive hourly range. The “Edit Hour Range” screen appears. Enter a start and end time in the appropriate text boxes.

**Edit Hour Range**

**NOTE:** Use military time to edit the hour range. (e.g. 2:30pm = 14:30)

Start time:	<input type="text" value="00"/>	:	<input type="text" value="00"/>
End time:	<input type="text" value="00"/>	:	<input type="text" value="00"/>

9. Click **Apply**.

**Note:** Make sure the FiOS Router’s date and time settings are properly configured for the time zone.

## 8.7 Firmware Upgrade

The FiOS Router offers a built-in mechanism for upgrading its firmware without losing custom configurations and settings. There are two methods for upgrading the firmware:

- **Upgrading from the Internet** - use this method to upgrade the FiOS Router's firmware by remotely downloading an updated software image file.
- **Upgrading from a local computer** - use a software image file pre-downloaded to the computer's disk drive to upgrade.

### 8.7a Upgrading From the Internet

The FiOS Router's firmware can be automatically updated via the Internet. From the drop-down list next to the globe icon near the top of the Firmware Upgrade screen, a list of options appears, as described below.

#### Automatically Check and Upgrade

If "Automatically Check for New Version and Upgrade Wireless Broadband Router" is selected, enter the period of time the FiOS Router checks for a new upgrade, and the URL at which to get the upgrade, in the appropriate text boxes. The FiOS Router will then check at each time interval for upgrades and, if one is available, upgrade the FiOS Router's firmware.

#### Automatically Check and Send E-mail

If "Automatically Check for New Version and Notify via Email" is selected, enter the period of time the FiOS Router checks for a new upgrade, and the URL at which to get the upgrade, in the appropriate text boxes. The FiOS Router will then check at each time interval for firmware upgrades and, if one is available, send an email to the address listed in the System Settings.

#### Automatic Check Disabled

If "Automatically Check Disabled" is selected, the FiOS Router will not automatically check for firmware upgrades.

## 8 Configuring Advanced Settings

### 8.7 Firmware Upgrade

#### Manual Checking and Upgrading

To manually upgrade the FiOS Router's firmware:

1. Click **Check Now** in the Firmware Upgrade screen.
2. If a new version is available, click **Force Upgrade**. A download process will begin. When downloading is completed, a confirmation screen appears, asking whether to upgrade to the new version.
3. Click **Apply**. The upgrade process will begin and should take no longer than one minute to complete.

At the conclusion of the upgrade process the FiOS Router automatically reboots. The new firmware runs, maintaining any custom configurations and settings.

#### 8.7b Upgrading From a Local Computer

To upgrade from a local computer:

1. Click **Firmware Upgrade** from the Advanced screen. The "Firmware Upgrade" screen appears.

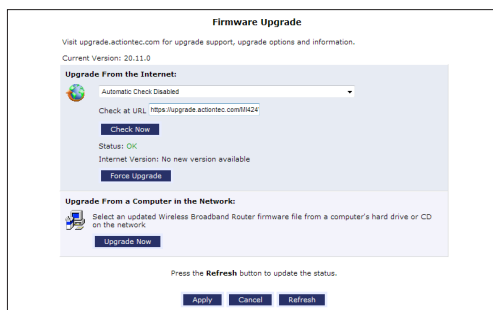



- In the “Upgrade From a Computer in the Network” section, click **Upgrade Now**. The “Upgrade From a Computer in the Network” screen appears.

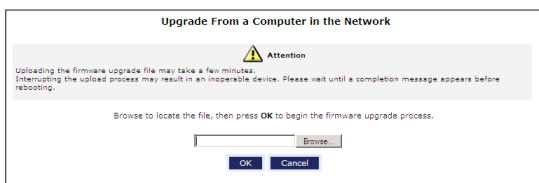

- Enter the path of the software image file, or press the “Browse” button to browse for the file, and click **Apply**. Make sure to only use files with an “rmt” extension when performing the firmware upgrade procedure.
- When loading is completed, a confirmation screen appears, asking whether to upgrade to the new version. Click **Apply**. The upgrade process begins and should take no longer than one minute to complete.
- When the upgrade process ends, the FiOS Router automatically reboots. The new firmware will run, maintaining any custom configurations and settings.

## 8.8 Routing Settings

The final section of the Advanced screen is Routing settings, which includes Routing and IP Address Distribution.

### 8.8a Routing

Access the routing table rules by clicking **Routing** in the Advanced screen. The “Routing” screen appears.

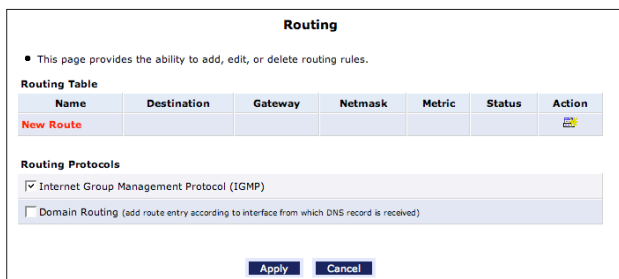

## 8 Configuring Advanced Settings

### 8.8 Routing Settings

Routing rules can be added, edited, or deleted from the Routing screen. To add a router, click **New Route**. The “Route Settings” screen appears.

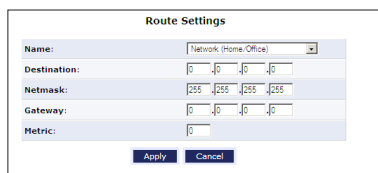

The screenshot shows a form titled "Route Settings" with the following fields:

Name:	Network (Home/Office)
Destination:	0 . 0 . 0 . 0
Netmask:	255 . 255 . 255 . 255
Gateway:	0 . 0 . 0 . 0
Metric:	0

At the bottom of the form are two buttons: "Apply" and "Cancel".

When adding a routing rule, the following parameters must be specified:

- **Rule Name** - Select the type of network from the drop-down list.
- **Destination** - The destination is the destination host, subnet address, network address, or default route. The destination for a default route is 0.0.0.0.
- **Netmask** - The network mask is used in conjunction with the destination to determine when a route is used.
- **Gateway** - Enter the FiOS Router’s IP address.
- **Metric** - A measurement of the preference of a route. Typically, the lowest metric is the most preferred route. If multiple routes exist to a given destination network, the route with the lowest metric is used.

### IGMP (Internet Group Management Protocol) Multicasting

The FiOS Router provides support for IGMP multicasting. A multicast is simply a message that is sent simultaneously to a pre-defined group of recipients. When joining a multicast group, all messages addressed to the group will be received by the user, much like when an email message is sent to a mailing list. To activate IGMP multicasting:

1. Select **Routing** in the Advanced screen.
2. Activate the “Internet Group Management Protocol” check-box.
3. Click **Apply**.

## Domain Routing

Domain routing is used in multi-router local network configurations. Normally, to access a device connected to one router from another router on the network, its IP address must be used. Activating domain routing (by clicking in the appropriate check box) allows the user access to the computer by name (as well as IP address).

### 8.8b IP Address Distribution

The FiOS Router's DHCP server makes it possible to easily add computers configured as DHCP clients to the network. It provides a mechanism for allocating IP addresses to these hosts and for delivering network configuration parameters to them.

For example, a client (host) sends out a broadcast message on the network requesting an IP address for itself. The DHCP server then checks its list of available addresses and leases a local IP address to the host for a specific period of time and simultaneously designates this IP address as "taken." At this point, the host is configured with an IP address for the duration of the lease.

The host can choose to renew an expiring lease or let it expire. If it chooses to renew a lease, it will also receive current information about network services, as it did with the original lease, allowing it to update its network configurations to reflect any changes that occurred since it first connected to the network. If the host wishes to terminate a lease before its expiration, it can send a release message to the DHCP server, which will then make the IP address available for use by others.

The FiOS Router's DHCP server:

- displays a list of all DHCP hosts devices connected to the FiOS Router;
- defines the range of IP addresses that can be allocated in the network;
- defines the length of time for which dynamic IP addresses are allocated;
- provides the above configurations for each network device and can be configured and enabled/disabled separately for each network device;

## 8 Configuring Advanced Settings



### 8.8 Routing Settings

- can assign a static lease to a network computer to receive the same IP address each time it connects to the network, even if this IP address is within the range of addresses that the DHCP server may assign to other computers;
- provides the DNS server with the host name and IP address of each computer connected to the network.

To view a summary of the services currently being provided by the DHCP server, click **IP Address Distribution** in the Advanced screen. The “IP Address Distribution” screen appears.

**IP Address Distribution**

• IP Address Distribution provides the ability to allocate IP addresses and configuration parameters to selected hosts

Name	Service	Subnet Mask	Dynamic IP Range	Action
Network (Home/Office)	DHCP Server	255.255.255.0	192.168.1.2 - 192.168.1.254	
Broadband Connection (Coax)	Disabled			

[Close](#) [Connection List](#) [Access Control](#)

### Editing DHCP Server Settings

To edit the DHCP server settings for a device:

1. Click the appropriate icon in the “Action” column. The “DHCP Settings” screen for the device appears.

**DHCP Settings for Network (Home/Office)**

Service

IP Address Distribution:

DHCP Server

Start IP Address:

End IP Address:

Subnet Mask:

WINS Server:

Lease Time in Minutes:

Provide Host Name If Not Specified by Client

IP Address Distribution According to DHCP Option 60 (Vendor Class Identifier)





Vendor Class ID	IP Address	MAC Address	QoS
-----------------	------------	-------------	-----

[Apply](#) [Cancel](#)

2. Select the "IP Address Distribution" from the drop-down list. Options include **DHCP Server**, **DHCP Relay**, or **Disable**.
3. Complete the following fields:
  - **Start IP Address Range, End IP Address Range** - determines the number of hosts connected to the network in this subnet. "Start" specifies the first IP address assigned in this subnet and "End" specifies the last IP address in the range.
  - **Subnet Mask** - used to determine to which subnet an IP address belongs. An example of a subnet mask value is 255.255.0.0.
  - **WINS Server** - The WINS (Windows Internet Naming Service) server determines the IP address associated with a network device.
  - **Lease Time** - each device will be assigned an IP address by the DHCP server for a limited time ("Lease Time") when it connects to the network. When the lease expires, the server will determine if the computer has disconnected from the network. If it has, the server may reassign this IP address to a newly-connected computer. This feature ensures that IP addresses not in use will become available for other computers on the network.
  - **Provide host name if not specified by client** - when activated, the FiOS Router assigns the client a default name if the DHCP client has no host name.
4. Click **Apply** to save the changes.

### DHCP Connections

To view a list of computers currently recognized by the DHCP server, click **Connection List** at the bottom of the IP Address Distribution screen. The "DHCP Connections" screen appears.

DHCP Connections							
Host Name	IP Address	Physical Address	Lease Type	Connection Name	Status	Expires In	Action
gateway2	192.168.1.2	00:90:27:b3:ce:49	Dynamic	Network (Home/Office)	Active	9931 minutes	  
<a href="#">New Static Connection</a>							

Press the **Refresh** button to update the data.

## 8 Configuring Advanced Settings

### 8.8 Routing Settings

To define a new connection with a fixed IP address:

1. Click **New Static Connection** in the DHCP Connections screen. The “DHCP Connection Settings” screen appears.

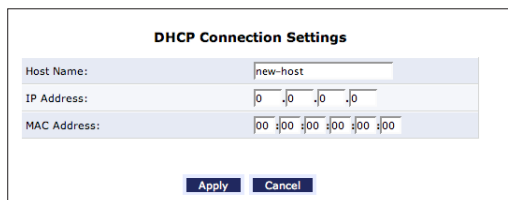

The screenshot shows a dialog box titled "DHCP Connection Settings". It contains three input fields: "Host Name:" with the text "new-host", "IP Address:" with four empty boxes for octets, and "MAC Address:" with six empty boxes for hex pairs. At the bottom are "Apply" and "Cancel" buttons.

DHCP Connection Settings	
Host Name:	new-host
IP Address:	0 0 0 0
MAC Address:	00 00 00 00 00 00

Apply Cancel

2. Enter a host name for this connection.
3. Enter the fixed IP address to assign to the computer.
4. Enter the MAC address of the computer's network card.
5. Click the **Apply** to save changes.

**Note:** A device's fixed IP address is actually assigned to the specific network card's MAC address installed on the network computer. If this network card is replaced, the device's entry in the DHCP Connections list must be updated with the new network card's MAC address.

To remove a host from the table, click the appropriate “Delete” icon in the Action column.

# 9

- 9.0** Introduction
- 9.1** Router Status
- 9.2** Advanced Status

# Monitoring the FiOS Router

**The FiOS Router's System Monitoring screens display important system information, including basic router settings, system log, key network device parameters, and network traffic statistics.**



## 9.1 Router Status

Click **System Monitoring** at the top of the Home screen to display the “Router Status” screen, which displays the FiOS Router’s basic settings.

Router Status	
Firmware Version:	20.11.0
Model Name:	MI424WR-GEN2
Hardware Version:	G
Serial Number:	CSJG0011300031
Physical Connection Type:	
Broadband Connection Type:	
Broadband Connection Status:	Disconnected
Broadband IP Address:	
Subnet Mask:	0.0.0.0
Broadband Mac Address:	00:1F:90:7F:A3:A0
Default Gateway:	
DNS Server:	
Active Status (Router Has Been Active For):	1 hours, 40 minutes
<input type="button" value="Close"/> <input type="button" value="Automatic Refresh On"/> <input type="button" value="Refresh"/>	

## 9.2 Advanced Status

After selecting **Advanced Status** and clicking **Yes** in the Warning screen, the monitoring options appear: **System Logging**, **Full Status/System wide Monitoring of Connections**, **Traffic Monitoring**, **Broadband Monitoring**, and **IGMP Proxy**.

Advanced Status	
Click on the link you wish to view	
<b>NOTE:</b> Only advanced technical users should use this feature.	
	
<b>System Logging</b>	
<b>Full Status/System wide Monitoring of Connections</b>	
<b>Traffic Monitoring</b>	
<b>Bandwidth Monitoring</b>	
<b>IGMP Proxy</b>	

# 9 Monitoring the FiOS Router

## 9.2 Advanced Status

### 9.2a System Logging

Click **System Logging** in the Advanced Status screen to generate the “System Log” screen. The System Log displays a list of the most recent activities of the FiOS Router.

**System Log**

[Close](#) [Save Log](#) [Refresh](#)

Press the **Refresh** button to update the data.

Time	Event	Event-Type	Details
Dec 14 19:00:38 2007	System Log	LAN DHCP	DHCP LAN Connection IP:192.168.1.3 DNS:192.168.1.1;GW:192.168.1.1;Subnet:255.255.255.0 (Ethernet)

[Close](#) [Advanced >>](#)

## 9.2b Full Status/System wide Monitoring of Connections

1. Click **Full Status/System wide Monitoring of Connections** in the Advanced Status screen (and click through the Warning screen) to generate the "Full Status/System wide Monitoring of Connections" screen, which features a table summarizing the monitored connection data.
2. Click **Refresh** to update the table, or click **Automatic Refresh On** to constantly update the displayed parameters.

Full Status/System wide Monitoring of Connections								
Name	Network (Home/Office)	Ethernet	Broadband Connection (Ethernet)	Coax	Broadband Connection (Coax)	Wireless Access Point	WAN PPPoE	WAN PPPoE 2
Status	Connected	Connected	Cable Disconnected	Cable Disconnected	Cable Disconnected	Connected	Waiting for Underlying Connection (Broadband Connection (Ethernet) - Cable Disconnected)	Disabled
Network	Network (Home/Office)	Network (Home/Office)	Broadband Connection	Network (Home/Office)	Broadband Connection	Network (Home/Office)	Broadband Connection	Broadband Connection
Underlying Device	Ethernet Wireless Access Point Coax Coax Stats						Broadband Connection (Ethernet)	Broadband Connection (Coax)
Connection Type	Bridge	Hardware Ethernet Switch	Ethernet	Coax	Coax	Wireless 802.11g Access Point	PPPoE	PPPoE
MAC Address	00:18:01:09:08:93	00:18:01:09:08:94	00:18:01:09:08:96	00:18:01:09:08:95	00:18:01:09:08:97	00:1f:90:e0:15:98		
IP Address	192.168.1.1							
Subnet Mask	255.255.255.0							
IP Address Distribution	DHCP Server	Disabled	Disabled	Disabled	Disabled	Disabled		
Service Name								
User Name							aefae51@sbcglobal.net	verizonfios
Received Packets	2796	2796				0		
Sent Packets	3245	18695				447		
Received Bytes	736306	797618				0		
Sent Bytes	2243830	3154964				103550		
Receive Errors	0	0				0		
Receive Drops	0	0				0		
Time Span	2:08:43	2:08:43				2:08:43		
Channel				Cable Disconnected	Cable Disconnected			

Close   Automatic Refresh On   Reset Statistics   Refresh

# 9 Monitoring the FiOS Router

## 9.2 Advanced Status

### 9.2c Traffic Monitoring

The FiOS Router constantly monitors traffic within the local network and between the local network and the Internet. To view up-to-the-second statistical information about data received from and transmitted to the Internet, and about data received from and transmitted to computers in the local network, click **Traffic Monitoring** in the Advanced Status screen. This generates the “Traffic Monitoring” screen.

Traffic Monitoring								
Name	Network (Home/Office)	Ethernet	Broadband Connection (Ethernet)	Coax	Broadband Connection (Coax)	Wireless Access Point	WAN PPPoE	WAN PPPoE 2
Status	Connected	Connected	Cable Disconnected	Cable Disconnected	Cable Disconnected	Connected	Waiting for Underlying Connection (Broadband Connection (Ethernet) - Cable Disconnected)	Disabled
Network	Network (Home/Office)	Network (Home/Office)	Broadband Connection	Network (Home/Office)	Broadband Connection	Network (Home/Office)	Broadband Connection	Broadband Connection
Underlying Device	Ethernet Wireless Access Point Coax Coax Stats						Broadband Connection (Ethernet)	Broadband Connection (Coax)
Connection Type	Bridge	Hardware Ethernet Switch	Ethernet	Coax	Coax	Wireless 802.11g Access Point	PPPoE	PPPoE
IP Address	192.168.1.1							
Received Packets	2949	2949				0		
Sent Packets	3424	19142				449		
Received Bytes	773787	838665				0		
Sent Bytes	2387087	3315735				103654		
Receive Errors	0	0				0		
Receive Drops	0	0				0		
Time Span	2:10:56	2:10:56				2:10:56		
<div style="text-align: right;"> <a href="#">Close</a>   <a href="#">Automatic Refresh On</a>   <a href="#">Reset Statistics</a>   <a href="#">Refresh</a> </div>								

### 9.2d Bandwidth Monitoring

To monitor the FiOS Router’s bandwidth use, click **Bandwidth Monitoring**. The “Bandwidth Monitor” screen appears.

Bandwidth Monitoring								
The recorded bandwidth usage will be measured in Kbps.								
Last Minute	1 Minute	2 Minutes	3 Minutes	4 Minutes	5 Minutes	6 Minutes	7 Minutes	8 Minutes
Tx Rate	0	0	0	0	0	0	0	0
Rx Rate	0	0	0	0	0	0	0	0
Last Hour	1 Hour	2 Hours	3 Hours	4 Hours	5 Hours	6 Hours	7 Hours	8 Hours
Tx Rate	0	0	0	0	0	0	0	0
Rx Rate	0	0	0	0	0	0	0	0
<div style="text-align: right;"> <a href="#">Close</a>   <a href="#">Automatic Refresh On</a>   <a href="#">Refresh</a> </div>								

## 9.2e IGMP Proxy

To monitor the FiOS Router's IGMP Proxy settings, click **IGMP Proxy**. The "IGMP Host Multicast Group Membership" screen appears, giving the user an overview of the IGMP Proxy status on the FiOS Router. For more information about how to set up IGMP proxy on the FiOS Router, see section 8.4e ("IGMP Proxy"). For more information about the FiOS Router's IGMP multicasting capabilities, see "IGMP Multicasting" in section 8.8 ("Routing Settings").

# 10

- 10.0** Introduction
- 10.1** Troubleshooting Tips
- 10.2** Frequently Asked Questions

# Troubleshooting

**This chapter lists a few of the problems that may be encountered while using the FiOS Router, and offers suggestions that may overcome them. Note that these suggestions may not solve the problem (or problems). Also included is a list of frequently asked questions.**

### 10.1 Troubleshooting Tips

#### Accessing the FiOS Router if Locked Out

If the FiOS Router's connection is lost while making configuration changes, a setting that locks access to the FiOS Router's GUI may have inadvertently been activated. There are three common ways to lock access to the FiOS Router:

**Scheduler** If a schedule has been created that applies to the computer over the connection being used, the FiOS Router will not be accessible during the times set in the schedule. To regain access, either wait until the connection is scheduled to be active again, or restore the default settings to the FiOS Router.

**LAN Firewall** If the firewall setting for the local network is set to maximum, no computers from the network will be able to connect to the FiOS Router. To gain access, restore the default settings to the FiOS Router.

**Access Control** If the access control setting for the computer is set to block the computer, access to the FiOS Router will be denied. To gain access, restore the default settings to the FiOS Router.

#### Restoring the FiOS Router's Default Settings

There are two ways to restore the FiOS Router's default settings. The first is to use the tip of a ballpoint pen and press and hold the "Reset" button on the back of the FiOS Router for at least ten seconds. The second is to access the FiOS Router's GUI and navigate to the "Advanced Settings" screen. Click **Restore Defaults** and read the instructions on-screen. Note that after performing either of these two procedures, all previously saved settings on the FiOS Router will be lost.



## LAN Connection Failure

- Ensure the FiOS Router is properly installed, the LAN connections are correct, and the power is on.
- Confirm the computer and FiOS Router are on the same network segment. If unsure, let the computer get the IP address automatically by initiating the DHCP function, then verify the computer is using an IP address within the default range (192.168.1.2 through 192.168.1.254). If the computer is not using an IP address within the range, it will not connect to the FiOS Router.
- Ensure the Subnet Mask address is set to 255.255.255.0.

## Time out error occurs when entering a URL or IP Address

- Verify all the computers are working properly.
- Ensure the IP settings are correct.
- Ensure the FiOS Router is on and connected properly.
- Verify the FiOS Router's settings are the same as the computer.

## 10.2 Frequently Asked Questions

### I've run out of Ethernet ports on my FiOS Router. How do I add more computers?

Plugging in an Ethernet hub or switch expands the number of ports on the FiOS Router. Run a standard Ethernet cable from the "Uplink" port of the new hub or switch to a yellow Ethernet port on the FiOS Router.

### How do I change the password on the FiOS Router's Graphical User Interface?

From the FiOS Router's GUI Home screen, click **Advanced**, then **Users**. From the "Users" screen, click **Administrator**, which generates the "User Settings" screen. In the "General" section of the screen, change the password.

### **Is the wireless option on by default on the FiOS Router?**

Yes. The FiOS Router's wireless option is activated out of the box.

### **Is the wireless security on by default when the wireless option is activated?**

Yes, with a unique WPA (Wi-Fi Protected Access) key that is printed on the sticker on the back of the FiOS Router.

### **Which connection speeds does the FiOS Router support?**

The Ethernet Internet connection supports 100 Mbps. The LAN Ethernet connections support 10/100/1000 Mbps. The 802.11n wireless connection supports up to 160 Mbps (depending on signal quality, etc.). The MoCA connection supports 270 Mbps.

### **Are the FiOS Router's Ethernet ports auto-sensing?**

Yes. Either a straight-through or crossover Ethernet cable can be used.

### **Can I use an 802.11b wireless card to connect to the FiOS Router?**

Yes, the FiOS Router can interface with 802.11b, g, or n cards. The FiOS Router can be setup to handle only n wireless cards, g wireless cards, b wireless cards, or any combination of the three.

### **Can my wireless signal pass through floors, walls, and glass?**

The physical environment surrounding the FiOS Router can have a varying effect on signal strength and quality. The more dense the object (a concrete wall compared to a plaster wall, for example), the greater the interference. Concrete or metal-reinforced structures will experience a higher degree of signal loss than those made of wood, plaster, or glass.

### **How do I find out what IP address my computer is using?**

**Windows 7** - Click the Windows button and select **Control Panel**. In the Control Panel, click **View Network Status and Tasks**. In the next window, click **Local Area Connection**. In the "Local Area Connection Status" window, click **Details**.

**Windows Vista** - Click the Windows button and select **Control Panel**. In the Control Panel, click **Network and Sharing Center**. In the "Network and Sharing Center" window, click **View Status**. In the "Local Area Connection Status" window, click **Details**.

**Windows 2000, XP** - Select **Start, Run** and type "cmd." Press **Enter**. When the command screen appears, type "ipconfig" and press **Enter**.

### **My computer cannot connect to the Internet via MoCA. What should I do?**

First, check the connection, and make sure all cables are connected correctly. Then make sure the NIM is still connected, and check the Ethernet connection to the NIM from the computer. A computer cannot be connected directly via a MoCA cable; it must go through a NIM to connect. The NIM converts the MoCA signal to an Ethernet signal the computer can understand.

### **I used DHCP to configure my network. Do I need to restart my computer to refresh my IP address?**

No. Follow these steps to refresh the IP address:

**Windows 7, Vista, XP** - Unplug the Ethernet cable or wireless card and plug it back in.

**Windows 2000** - Select **Start, Run**, type "cmd," and press **Enter**. At the DOS prompt, type "ipconfig /release" and press **Enter**, then type "ipconfig /renew" and press **Enter**.

### **I cannot access the FiOS Router's Graphical User Interface? What should I do?**

If you cannot access the FiOS Router's Graphical User Interface (GUI), make sure the computer connected to the FiOS Router is set up to dynamically receive an IP address.

### **I have an FTP or Web server on my network. How can I make it available to users on the Internet?**

For a Web server, enable port forwarding for port 80 to the IP address of the server. Also, set up the Web server to receive on that port. (Configuring the server to use a static IP address is recommended.)

For an FTP server, enable port forwarding for port 21 to the IP address of the server. (Configuring the server to use a static IP address is recommended.)

### **How many computers can be connected through the FiOS Router?**

The FiOS Router is capable of 254 connections, but we recommend having no more than 45 connections. As the number of connections increase, the available speed for each computer decreases.

### **What is the default user name for the FiOS Router?**

The default user name for the FiOS Router is "admin" (all lower case, no quotation marks). When logging into the FiOS Router the first time (or after restoring the FiOS Router's default settings), the user is asked to create a new user name and password. Enter the new user name and password, write them down on a piece of paper, and keep it in a safe place. The new user name and password will be needed to access the FiOS Router's GUI in the future.

# A

- A.0** Introduction
- A.1** Traffic Priority
- A.2** Traffic Shaping

# Configuring Quality of Service

Quality of Service refers to the capability of a network device to provide better service to selected network traffic. This is achieved by shaping the traffic and processing higher priority traffic before lower priority traffic. The FiOS Router provides several different methods of configuring Quality of Service.

**STOP!** Do not change any Quality of Service settings unless instructed to do so by the ISP.

## A.1 Traffic Priority

Traffic Priority manages and avoids traffic congestion by defining inbound and outbound priority rules for each device on the FiOS Router. These rules determine the priority that packets, traveling through the device, will receive. QoS parameters (DSCP marking and packet priority) are set per packet, on an application basis.

QoS can be configured using flexible rules, according to the following parameters:

- Source/destination IP address, MAC address, or host name
- Device
- Source/destination ports
- Limit the rule for specific days and hours

The FiOS Router supports two priority marking methods for packet prioritization:

- DSCP
- 802.1p Priority

The matching of packets by rules is connection-based, known as Stateful

Packet Inspection (SPI), using the FiOS Router's firewall mechanism. Once a packet matches a rule, all subsequent packets with the same attributes receive the same QoS parameters, both inbound and outbound. Connection-based QoS also allows inheriting QoS parameters by some of the applications that open subsequent connections. For instance, QoS rules can be defined on SIP, and the rules will apply to both control and data ports (even if the data ports are unknown). Applications that support such inheritance have an ALG in the firewall. They are:

- SIP
- MSN Messenger/Windows Messenger
- TFTP
- FTP
- MGCP
- H.323
- Port triggering applications
- PPTP
- IPSec



## A.1a Setting Priority Rules

To set priority rules:

1. Click **Quality of Service** in the Advanced screen. The “Traffic Priority” screen appears. This screen is divided into two identical sections, one for “QoS input rules” and the other for “QoS output rules,” which are for prioritizing the inbound and outbound traffic, respectively. Each section lists all the devices on which rules can be set. Rules can be set on all devices at once by clicking **Add** in the “All Devices” row.

**Traffic Priority**

**QoS Input Rules**

Rule ID	Source Address	Destination Address	Match	Operation	Status	Action
Network (Home/Office) Rules						Add
Ethernet Rules						Add
Broadband Connection (Ethernet) Rules						Add
Coax Rules						Add
Broadband Connection (Coax) Rules						Add
Wireless Access Point Rules						Add
WAN PPPoE Rules						Add

**QoS Output Rules**

Rule ID	Source Address	Destination Address	Match	Operation	Status	Action
Network (Home/Office) Rules						Add
Ethernet Rules						Add
Broadband Connection (Ethernet) Rules						Add
Coax Rules						Add
Broadband Connection (Coax) Rules						Add
Wireless Access Point Rules						Add
WAN PPPoE Rules						Add

# A Configuring Quality of Service

## A.1 Traffic Priority

2. After choosing the traffic direction and the device on which to set the rule, click **Add** in the appropriate row. The “Add Traffic Priority Rule” screen appears.

The screenshot shows the 'Add Traffic Priority Rule' configuration interface. It is organized into several sections:

- Matching:** Includes 'Source Address' (Any), 'Destination Address' (Any), and 'Protocol' (Any).
- Operation:** Includes checkboxes for 'DSCP', 'Priority', and 'Length'. Below these are options to 'Set DSCP', 'Set Priority', 'Set Rx Class Name', and 'Set Tx Class Name', each with an unchecked checkbox.
- Apply QoS on:** A dropdown menu currently set to 'Connection'.
- Logging:** A checkbox for 'Log Packets Matched by This Rule' which is unchecked.
- When should this rule occur?:** A dropdown menu currently set to 'Always'.

At the bottom of the form are two buttons: 'Apply' and 'Cancel'.

Set the following parameters:

### Source Address

The source address of the packets sent to or received from the network object. To add an address:

1. Select “User Defined” from the drop-down list. The screen refreshes and an “Add” link appears.
2. Click **Add**, then add a new network object (see the “Advanced Settings” chapter to learn how to add a network object). Clicking Add is the same as clicking New Entry in the Network Objects screen.

### Destination Address

The destination address of the packets sent to or received from the network object. This address can be configured in the same manner as the source address.

## Protocol

Choose a specific traffic protocol from the drop-down list, or add a new one. To add a new traffic protocol:

1. Select "User Defined" from the drop-down list. The screen refreshes and an "Add" link appears.
2. Click **Add**, and add a new protocol (see the "Advanced Settings" chapter to learn how to add a protocol). Note that clicking Add is equivalent to clicking New Entry in the Protocols screen.

## Set Priority

Activate this check box to add a priority to the rule. The screen will refresh, allowing a selection between one of eight priority levels, zero being the lowest and seven the highest (each priority level is mapped to low/medium/high priority). This sets the priority of a packet on the connection matching the rule, while routing the packet.

## Set DSCP

Activate this check box to mark a DSCP value on packets matching a connection that matches this rule. The screen will refresh, allowing the user to enter the Hex value of the DSCP.

## Log Packets Matched by This Rule

Check this check box to log the first packet from a connection matched by this rule.

## Schedule

By default, the rule will always be active. However, scheduler rules can be configured to define time segments during which the rule may be active.

### A.2 Traffic Shaping

Traffic Shaping is the solution for managing and avoiding congestion where the network meets limited broadband bandwidth. Typical networks use a 100 Mbps Ethernet LAN with a 100 Mbps WAN interface router, which is where most bottlenecks occur.

A traffic shaper is essentially a regulated queue that accepts uneven and/or bursty flows of packets and transmits them in a steady, predictable stream so that the network is not overwhelmed with traffic. While traffic priority allows basic prioritization of packets, traffic shaping provides more sophisticated definitions, such as:



- Bandwidth limit for each device
- Bandwidth limit for classes of rules
- Prioritization policy
- TCP serialization on a device

Additionally, QoS traffic shaping rules can be defined for a default device. These rules will be used on a device that has no definitions of its own. This enables the definition of QoS rules on the default WAN, for example, and their maintenance even if the PPP or bridge device over the WAN is removed.

#### A.2a Device Traffic Shaping

This section describes the different Traffic Shaping screens and terms, and presents the feature's configuration logic.

1. Click **Quality of Service** in the Advanced screen, then click **Traffic Shaping**. The following screen appears.

Traffic Shaping				
Device	Tx Bandwidth (Kbps)	Rx Bandwidth (Kbps)	TCP Serialization	Action
<input checked="" type="checkbox"/> Default WAN device				 
<a href="#">Add</a>				

[Apply](#) [Cancel](#)

2. Click **Add**. The “Add Device Traffic Shaping” screen appears.
3. Select the device for which the traffic will be shaped. The drop-down list includes all the FiOS Router’s devices, as well as the option to select all devices in each category (e.g., “All LAN Devices,” “All WAN Devices”). In this example, select the default WAN device option.

**Add Device Traffic Shaping**

Device:

4. Click **Apply**. The “Edit Device Traffic Shaping” screen appears.

**Edit Device Traffic Shaping**

Device:

**Tx Traffic Shaping**

Tx Bandwidth:   Kbps

TCP Serialization:

Queue Policy:

Class ID	Name	Priority	Bandwidth		Status	Action
			Reserved	Maximum		
default	default	4	0 Kbps	Unlimited	Active	
<input type="button" value="Add"/>						

**Rx Traffic Policing**

Rx Bandwidth:   Kbps

Class ID	Name	Bandwidth		Status	Action
		Reserved	Maximum		
<input type="button" value="Add"/>					

Configure the following parameters:

### Tx Bandwidth

Tx bandwidth limits the FiOS Router’s bandwidth transmission rate. The purpose is to limit the bandwidth of the WAN device to that of the weakest outbound link.. This forces the FiOS Router to be the network bottleneck, where sophisticated QoS prioritization can be performed.

### TCP Serialization

Enable TCP Serialization from its drop-down list, either for active voice calls only or for all traffic. The screen will refresh, adding a “Maximum Delay” text box. This function allows the maximum allowed transmission time frame (in milliseconds) of a single packet to be defined. Any packet requiring a longer time to be transmitted will be fragmented to smaller sections. This avoids transmission of large, bursty packets that can cause delay or jitter for real-time traffic, such as VoIP.

### Queue Policy

The class policy determines the traffic policy of routing packets inside the class. Depending on the type of device, options include **Strict Policy** and **Class Based**.

### Rx Bandwidth

In the same manner, this Rx bandwidth limits the FiOS Router’s bandwidth reception rate.

## A.2b Shaping Classes

The bandwidth of a device can be divided to reserve constant portions of bandwidth to predefined traffic types. Such a portion is known as a shaping class. When not used by its predefined traffic type or owner (for example VoIP), the class will be available to all other traffic. However, when needed, the entire class is reserved solely for its owner. Also, the maximum bandwidth that a class uses can be limited, even if the entire bandwidth is available.

When a shaping class is defined for a specific traffic type, two shaping classes are created. The second class is the “Default Class”, which is responsible for all the packets that do not match the defined shaping class, or any other classes that might be defined on the device. This can be viewed in the “Class Statistics” screen.

To define a shaping class:

1. Click **Add** in the “Tx Traffic Shaping” section of the Edit Device Traffic Shaping screen. The “Add Shaping Class” screen appears.

2. Name the new class and click **Apply**.
3. Click the class name in the Edit Device Traffic Shaping screen to edit the shaping class. The “Edit Shaping Class” screen appears.

Configure the following parameters:

### Class Priority

Select the priority of this class from the drop-down menu (0 being highest priority, while 7 is lowest).

### Bandwidth

**Reserved** - Enter the amount of bandwidth (in Kbits/second) to be reserved for this class only.

**Maximum** - Select the amount of bandwidth available to this class. Options include **Unlimited** or **Specify**. If Specify is enabled, enter the bandwidth amount (in Kbits/second, or as a percentage of the total bandwidth) in the appropriate text box.

### Policy

Select a QoS policy from the drop-down menu. Options include Priority, FIFO (First In, First Out), Fairness (balanced set), RED (Random Early Detection), and WRR (Weighted Round Robin).

### When should this rule occur?

By default, the rule will always be active. However, scheduler rules can be configured to define time periods during which the rule is active. To learn how to configure scheduler rules, see the “Advanced Settings” chapter.

### A.2c Ingress Data

The FiOS Router can control outgoing data fairly easily. It can queue packets, delay them, give precedence to other packets, or drop them. This helps in resolving upload (Tx) traffic bottlenecks, and in most cases is sufficient. However, in the case of download (Rx) traffic bottlenecks, the ability to control the flow is much more limited. The FiOS Router cannot queue packets, since in most cases the local network (LAN) is much faster than the Internet (WAN), and when the FiOS Router receives a packet from the Internet, it passes it immediately to the local network.

QoS for ingress data has the following limitations, which do not exist for outgoing data:

- QoS can only be applied to TCP streams (UDP streams cannot be delayed);
- no borrowing mechanism;
- and when reserving Rx bandwidth, it is strictly taken from the bandwidth of all other classes.

Furthermore, the FiOS Router cannot control the behavior of the ISP, which may not have proper QoS handling. Unfortunately, this is a common situation. Let's look at a scenario of downloading a large file and surfing the Internet at the same time. Downloading the file is distinguished by small requests, followed by very large responses. This may result in blocking HTML traffic at the ISP. A solution for such a situation is limiting the bandwidth of low-priority TCP connections (such as the file download).



## A.2d Differentiated Services Code Point Settings



































In order to understand what DSCP is, one must first be familiarized with the Differentiated Services model.

Differentiated Services (Diffserv) is a Class of Service (CoS) model that enhances best-effort Internet services by differentiating traffic by users, service requirements, and other criteria. Packets are specifically marked, allowing network nodes to provide different levels of service, as appropriate for voice calls, video playback, or other delay-sensitive applications, via priority queuing or bandwidth allocation, or by choosing dedicated routes for specific traffic flows.

Diffserv defines a field in IP packet headers referred to as the Differentiated Services Codepoint (DSCP). Hosts or routers passing traffic to a Diffserv-enabled network will typically mark each transmitted packet with an appropriate DSCP. The DSCP markings are used by Diffserv network routers to appropriately classify packets and to apply particular queue handling or scheduling behavior.

The FiOS Router provides a table of predefined DSCP values, which are mapped to 802.1p priority marking method. Any of the existing DSCP setting can be edited or deleted, and new entries can be added.

1. Click **Quality of Service** at the top of the Home screen, then click **DSCP Settings**. The "DSCP Settings" screen appears.

DSCP Value (hex)	802.1p Priority	Action
0x0	0 (Queue 0 - Low)	 
0x2	0 (Queue 0 - Low)	 
0x4	4 (Queue 1 - Medium)	 
0x6	4 (Queue 1 - Medium)	 
0x8	2 (Queue 0 - Low)	 
0xA	1 (Queue 0 - Low)	 
0xC	3 (Queue 0 - Low)	 
0xE	2 (Queue 0 - Low)	 
0x10	7 (Queue 2 - High)	 
0x12	6 (Queue 2 - High)	 
0x14	7 (Queue 2 - High)	 
0x16	6 (Queue 2 - High)	 
0x18	5 (Queue 1 - Medium)	 
0x1A	5 (Queue 1 - Medium)	 
0x1C	5 (Queue 1 - Medium)	 
0x1E	5 (Queue 1 - Medium)	 
0x2E	7 (Queue 2 - High)	 
Add		

[Close](#)

- To edit an existing entry, click the appropriate icon in the “Action” column. To add a new entry, click **Add**. In either case, the “Edit DSCP Settings” screen appears.

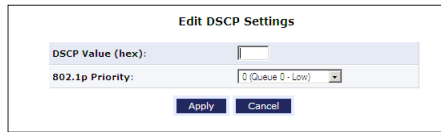

The screenshot shows a dialog box titled "Edit DSCP Settings". It has two main input areas: "DSCP Value (hex):" which is a text input field, and "802.1p Priority:" which is a dropdown menu currently set to "0 (Queue 0 - Low)". At the bottom of the dialog are two buttons: "Apply" and "Cancel".

- Configure the following parameters:

**DSCP Value (hex)** - Enter the DSCP value as a hexadecimal value.

**802.1p Priority** - Select a 802.1p priority level from the drop-down list, zero being the lowest and seven the highest (each priority level is mapped to low/medium/high priority). The default DSCP value for packets with an unassigned value is zero.

- Click **Apply** to save the settings.

### A.2e 802.1p Settings

The IEEE 802.1p priority marking method is a standard for prioritizing network traffic at the data link/Mac sub-layer. 802.1p traffic is simply classified and sent to the destination, with no bandwidth reservations established.

The 802.1p header includes a 3-bit prioritization field, which allows packets to be grouped into eight levels of priority. By default, the highest priority is seven, which might be assigned to network-critical traffic. Values five and six may be applied to delay-sensitive applications such as interactive video and voice. Data classes four through one range from controlled-load applications down to “loss eligible” traffic. Zero is the value for unassigned traffic and used as a best effort default, invoked automatically when no other value has been set.

A packet can match more than one rule. This means that:

- The first class rule has precedence over all other class rules (scanning is stopped once the first rule is reached).
- The first traffic-priority (classless) rule has precedence over all other traffic priority rules.
- There is no prevention of a traffic-priority rule conflicting with a class rule. In this case, the priority and DSCP setting of the class rule (if given) will take precedence.

1. Click **Quality of Service** in the Advanced screen, then click **802.1p Settings**. The “802.1p Settings” screen appears.

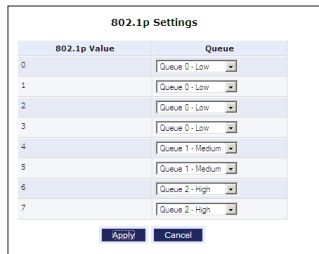

2. The eight 802.1p values are pre-populated with the three priority levels: **Low**, **Medium**, and **High**. These levels can be changed for each of the eight values in their respective drop-down lists.

3. Click **Apply** to save the settings.

### A.2f Class Statistics

The FiOS Router provides accurate, real-time information on the traffic moving through the defined device classes. For example, the amount of packets sent, dropped, or delayed are just a few of the parameters monitored per each shaping class.

To view class statistics, click **Quality of Service** at the top of the Home screen, then click **Class Statistics**. The following screen appears. Note that class statistics will only be available after defining at least one class (otherwise the screen will not present any information).

Class Statistics						
Class	Packets Sent	Bytes Sent	Packets Dropped	Packets Delayed	Rate (bytes/s)	Packet Rate
<b>Network (Home/Office)</b>						
default	1002	675472	0	0	566	1
Class	0	0	0	0	0	0
Class 2	0	0	0	0	0	0

[Close](#) [Automatic Refresh On](#) [Refresh](#)

### A.2g Class Identifier

To create a class identifier, click **Quality of Service** in the Advanced screen, then click **Class Identifier**. The “Class Identifier” screen appears.

Class Identifier	
DHCP Option 60 (Vendor Class Identifiers):	<input type="text"/>
Start IP Address:	<input type="text"/> <input type="text"/> <input type="text"/> <input type="text"/>
End IP Address:	<input type="text"/> <input type="text"/> <input type="text"/> <input type="text"/>
<input checked="" type="checkbox"/> Set Priority	<input type="text"/> (Queue 2 - High) <input type="text"/>

[Apply](#) [Cancel](#)

Enter the information needed in the appropriate text boxes, then click **Apply**.

# B

- B.0** Introduction
- B.1** General
- B.2** LED Indicators
- B.3** Environmental

# Specifications

**This appendix lists the FiOS Router's specifications, including standards, cabling types, and environmental parameters.**

**Note that the specifications listed in this appendix are subject to change without notice.**

## B.1 General

### Model Number

MI424WR rev. G (FiOS Router)

### Standards

IEEE 802.3x, 802.3u

IEEE 802.11b, g, n (wireless)

### IP

IP version 4

### MoCA

Two channels (WAN, LAN)

WAN MoCA frequency: 975 MHz - 1025 MHz (single channel)

LAN MoCA frequency: 1125 MHz - 1425 MHz (6 channel)

### Speed

#### Wired

LAN Ethernet: 10/100/1000 Mbps auto-sensing

#### Wireless

802.11b - up to 11 Mbps

802.11g - up to 54 Mbps

802.11n - up to 160 Mbps

### Cabling Type

Ethernet 10BaseT: UTP/STP Category 3 or 5

Ethernet100BaseTX: UTP/STP Category 5

Ethernet1000BaseTX: UTP/STP Category 5e

### Firewall

ICSA certified

## **B.2 LED Indicators**

Power, WAN Ethernet, WAN Coax, Internet, LAN Ethernet (4), LAN Coax, USB (2), Wireless, WPS

## **B.3 Environmental Parameters**

### **Dimensions**

**Size:** 1.875" x 10" x 7.4"

**Weight:** 2.175 lbs.

### **Power**

External, 10V DC, 1.6A (Adapter Technology Co., Ltd.; model #: STD 10016U)

### **Certifications**

FCC Part 15, UL-60959-1

### **Operating Temperature**

0° C to 40° C (32° F to 104° F)

### **Storage Temperature**

-20° C to 70° C (-4° F to 158° F)

### **Operating Humidity**

8% to 93% (non-condensing)

### **Storage Humidity**

5% to 100% (non-condensing)





- C.0** Introduction
- C.1** Regulatory  
Compliance Notices
- C.2** Modifications
- C.3** NEBS Requirements
- C.4** GPL

# Notices

**This appendix lists various compliance and modification notices, as well as the NEBS requirements and GPL.**

## C.1 Regulatory Compliance Notices

### Class B Equipment

This equipment has been tested and found to comply with the limits for a Class B digital device, pursuant to Part 15 of the FCC Rules. These limits are designed to provide reasonable protection against harmful interference in a residential installation. This equipment generates, uses, and can radiate radio frequency energy and, if not installed and used in accordance with the instructions, may cause harmful interference to radio communications. However, there is no guarantee that interference will not occur in a particular installation. If this equipment does cause harmful interference to radio or television reception, which can be determined by turning the equipment off and on, the user is encouraged to try to correct the interference by implementing one or more of the following measures:

- Reorient or relocate the receiving antenna;
- Increase the separation between the equipment and receiver;
- Connect the equipment to an outlet on a circuit different from the one to which the receiver is connected;
- Consult the dealer or an experienced radio or television technician for help.

### C.2 Modifications

The FCC requires the user to be notified that any changes or modifications made to this device that are not expressly approved by Actiontec Electronics, Inc., may void the user's authority to operate the equipment.

Declaration of conformity for products marked with the FCC logo – United States only.

This device complies with Part 15 of the FCC Rules. Operation is subject to the following two conditions:

1. This device may not cause harmful interference;

2. This device must accept any interference received, including interference that may cause unwanted operation.

**Note:** To comply with FCC RF exposure compliance requirements, the antenna used for this transmitter must be installed to provide a separation distance of at least 20 cm from all persons and must not be co-located or operating in conjunction with any other antenna or transmitter.

For questions regarding your product or the FCC declaration, contact:

Actiontec Electronics, Inc.  
760 North Mary Ave.  
Sunnyvale, CA 94085  
United States  
Tel: (408) 752-7700  
Fax: (408) 541-9005

### C.3 NEBS Requirements

The coaxial cable screen shield must be connected to the Earth at the building entrance per ANSI/NFPA 70, the National Electrical Code (NEC), in particular Section 820.93, "Grounding of Outer Conductive Shield of a Coaxial Cable," or in accordance with local regulation.

**Warning!** The red WAN Coax Port is intended for connection to Verizon FiOS only. It must not be connected to any exterior or interior coaxial wires not designated for Verizon FiOS.

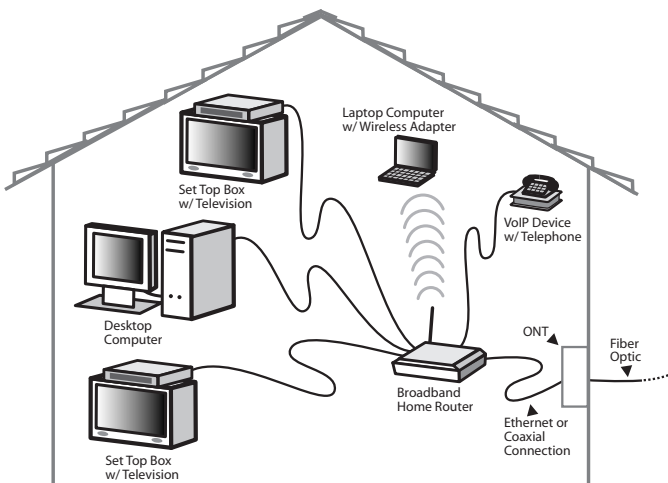

Typical Broadband Home Router Installation

**Caution:** The Broadband Home Router must be installed inside the home. The Router is not designed for exterior installation.

### C.4 GPL (General Public License)

This product includes software code developed by third parties, including software code subject to the enclosed GNU General Public License (GPL) or GNU Lesser General Public License (LGPL). The GPL Code and LGPL Code used in this product are distributed WITHOUT ANY WARRANTY and are subject to the copyrights of the authors, and to the terms of the applicable licenses included in the download. For details, see the GPL Code and LGPL Code for this product and the terms of the GPL and the LGPL.