

Wireless Broadband Router

MI424WR
rev. I

User Manual



Contents

FiOS Router User Manual

1

Introduction

- 1.0 Introduction
- 1.1 Package Contents
- 1.2 System Requirements
- 1.3 Features
- 1.4 Getting to Know the FiOS Router

2

Connecting the FiOS Router

- 2.0 Introduction
- 2.1 Setting Up the FiOS Router
- 2.2 Computer Network Configuration
- 2.3 Configuring the FiOS Router
- 2.4 Features
- 2.5 Main Screen

3

Setting Up a Wireless Network

- 3.0 Introduction
- 3.1 Overview
- 3.2 Connecting a Wireless Client
- 3.3 Wireless Status
- 3.4 Basic Security Settings
- 3.5 Advanced Security Settings
- 3.6 Setting Up a Wireless Client

4

Configuring My Network Settings

- 4.0 Introduction
- 4.1 Accessing My Network Settings
- 4.2 Using My Network Settings

Contents

FiOS Router User Manual (con't)

5

Using Network Connections

- 5.0 Introduction
- 5.1 Accessing Network Connections
- 5.2 Network (Home/Office) Connection
- 5.3 Ethernet/Coax Connection
- 5.4 Wireless Access Point Connection
- 5.5 Broadband Ethernet/Coax Connection
- 5.6 WAN PPPoE Connection

6

Configuring Security Settings

- 6.0 Introduction
- 6.1 Overview
- 6.2 Firewall
- 6.3 Access Control
- 6.4 Port Forwarding
- 6.5 DMZ Host
- 6.6 Port Triggering
- 6.7 Remote Administration
- 6.8 Static NAT
- 6.9 Advanced Filtering
- 6.10 Security Log

7

Parental Controls

- 7.0 Introduction
- 7.1 Activating Parental Controls
- 7.2 Rule Summary

Contents

FiOS Router User Manual (con't)

8

Configuring Advanced Settings

- 8.0 Introduction
- 8.1 Using Advanced Settings
- 8.2 Utilities
- 8.3 DNS Settings
- 8.4 Network Settings
- 8.5 Configuration Settings
- 8.6 Time Settings
- 8.7 Firmware Upgrade
- 8.8 Routing Settings

9

Monitoring the FiOS Router

- 9.0 Introduction
- 9.1 Router Status
- 9.2 Advanced Status

10

Troubleshooting

- 10.0 Introduction
- 10.1 Troubleshooting Tips
- 10.2 Frequently Asked Questions

A

Configuring Quality of Service

- A.0 Introduction
- A.1 Traffic Priority
- A.2 Traffic Shaping

Contents

FiOS Router User Manual (con't)

B

Specifications

- B.0** Introduction
- B.1** General
- B.2** LED Indicators
- B.3** Environmental

C

Notices

- C.0** Introduction
- C.1** Regulatory Compliance Notices
- C.2** Modifications
- C.3** NEBS Requirements
- C.4** GPL

1

- 1.0** Introduction
- 1.1** Package Contents
- 1.2** System Requirements
- 1.3** Features
- 1.4** Getting to Know the FiOS Router

Introduction

The Verizon FiOS® Router lets you transmit and distribute digital entertainment and information to multiple devices via coaxial cables. The FiOS Router also supports Ethernet and Wi-Fi networking, making it one of the most versatile and powerful routers available.

1

Introduction

1.1 Package Content

1.1 Package Content

The following is a list of the items included with the FiOS Router:

- Black Power adapter
- Yellow cable (Ethernet, 6 ft.)
- White cable (Ethernet, 10 ft.)
- Quick Start Guide
- Installation Guide
- User Manual CD
- Wireless Networking Guide
- Wall-mount template
- Vertical stand

1.2 Minimum System Requirements

The FiOS Router must be used with the following systems and software:

- Computer with Ethernet capability
- Microsoft Windows 2000, XP, Vista, or 7; Mac OS 10.1 or greater; Linux/BSD, Unix
- Internet Explorer 5.0 or higher; Netscape Navigator 7.0 or higher
- TCP/IP network protocol installed on each computer

1.3 Features

The FiOS Router features:

- Multiple networking standards support, including:
 - WAN - Ethernet and MoCA interfaces
 - LAN - 802.11b/g/n, Ethernet, and MoCA interfaces
- Integrated wired networking with 4-port 10/100/1000 Mbps Ethernet switch and MoCA
- Integrated wireless networking with 802.11b/g/n access point featuring:
 - 802.11n enabled to support speeds up to 160 Mbps wirelessly
 - 802.11g enabled to support speeds up to 54 Mbps wirelessly
 - 802.11b compatibility, communicating with 802.11b wireless products at speeds up to 11 Mbps
- Enterprise-level security, including:
 - Fully customizable firewall with Stateful Packet Inspection
 - Content filtering with URL-keyword based filtering, parental control, customizable filtering policies per computer, and E-mail notification
 - Denial of service protection against IP spoofing attacks, intrusion and scanning attacks, IP fragment overlap, ping of death, and fragmentation attacks
 - Event logging
 - Intrusion detection
 - MAC address filtering
 - NAT
 - DMZ hosting
 - Access control
 - Advanced wireless protection featuring WPA, WPA2, WEP 64/128 bit encryption, 802.1x authentication, and MAC address filtering
 - ICSA certification

1 Introduction

1.3 Features

- Other options, including:
 - DHCP server option
 - DHCP server/PPPoE server auto-detection
 - DNS server
 - LAN IP and WAN IP address selection
 - MAC address cloning
 - Port forwarding
 - PPPoE support
 - QoS support (end to end layer 2/3) featuring Diffserv, 802.1p/q prioritization, configurable upstream/downstream traffic shaping, random early detection and pass-through of WAN-side DSCPs, PHBs, and queuing to LAN-side devices
 - Remote management and secured remote management using HTTPS
 - Reverse NAT
 - Static NAT
 - Static routing
 - Time zone support
 - VLAN multicast support
 - VPN IPSec (VPN pass-through only)

1.4 Getting to Know the FiOS Router

This section contains a quick description of the FiOS Router’s lights (LEDs), ports, etc. The FiOS Router has several indicator lights on its front panel, a sticker on its bottom panel, and a series of ports and switches on its rear panel.

1.4a Front Panel

The front panel of the FiOS Router has a series of indicator lights: Power, WAN Ethernet, WAN Coax, Internet, LAN Ethernet (4), LAN Coax, USB (2), and Wireless. It also features a WPS button.

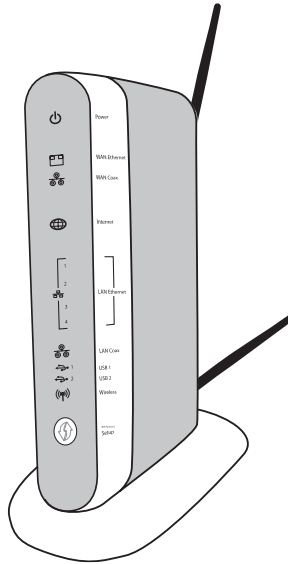

Front view – Verizon FiOS Router (rev. 1)

1

Introduction

1.4 Getting to Know the FiOS Router

Power

The Power LED displays the FiOS Router's current status. If the Power light glows steadily green, the FiOS Router is receiving power and fully operational. When the Power light flashes rapidly, the FiOS Router is initializing. If the Power light is not illuminated when the Power cord is plugged in and the Power switch is turned on, or if the Power light glows red for more than 3 minutes, the FiOS Router has suffered a critical error and technical support should be contacted.

WAN Ethernet

The WAN Ethernet LED illuminates when the FiOS Router is connected to the Internet via Ethernet. If flashing, data traffic is passing across the port.

WAN Coax

The WAN Coax LED glows steadily or flashes when the FiOS Router is connected to the Internet via coaxial cable.

Internet

When the Internet LED glows steadily green, the FiOS Router is connected to the ISP (Internet Service Provider). If it glows amber, there is a physical connection to the ONT (Optical Network Terminator), but authentication has not taken place (i.e., no IP address is present).

LAN Ethernet (1, 2, 3, 4)

The LAN Ethernet LEDs illuminate when the FiOS Router is connected to a local network via one or more of its Ethernet ports. If flashing, data traffic is passing across the port(s).

LAN Coax

The LAN Coax LED glows steadily or flashes when the FiOS Router is connected to a local network via its Coax port.

USB (1, 2)

The USB LEDs illuminate when the FiOS Router is connected to a device via one of its USB ports. These ports are currently inoperational; they will be activated in a future firmware update.

Wireless

The Wireless LED illuminates when the FiOS Router’s wireless access point is turned on. If flashing, data traffic is passing across the wireless connection.

Wi-Fi Protected Setup

WiFi Protected Setup (WPS) is an easier way to set up a wireless network. Instead of entering passwords or multiple keys on each wireless client (laptop, printer, external hard drive, etc.), the FiOS Router can create a wireless network that only requires the pressing of buttons (one on the FiOS Router, and one on the client [either built-in, or on a compatible wireless card]) to allow wireless clients to join the FiOS Router’s wireless network. Although the WPS button is included on the FiOS Router, WPS functionality will not be enabled until a future firmware release. The button is included so that WPS can be activated at a later date without having to physically change the FiOS Router. The GUI does not include the WPS option.

1.4b Bottom Panel

The bottom panel of the FiOS Router has a sticker that contains important information about the FiOS Router, including default user name and password, ESSID, wireless keys, etc.

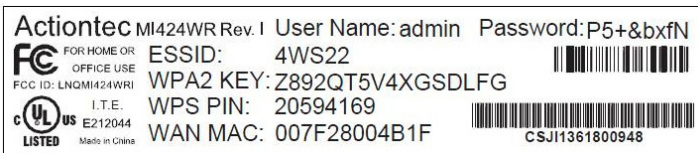

1

Introduction

1.4 Getting to Know the FiOS Router

1.4c Rear Panel

The rear panel of the FiOS Router has eight ports (Coax, Power, LAN Ethernet [4], WAN Ethernet, and USB), a Power switch, a Reset button, and two wireless antennas.

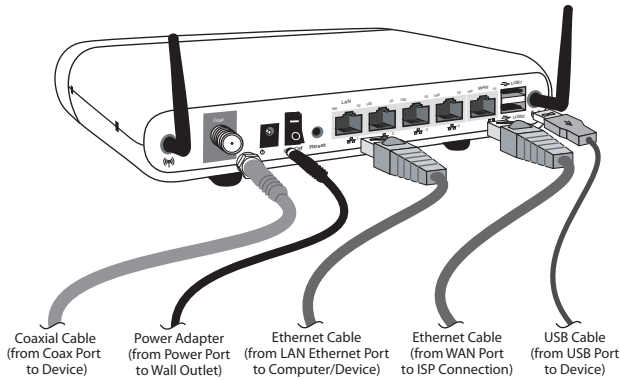

Rear view – Verizon FiOS Router (rev. I)

Coax Port

The Coax port connects the FiOS Router to the ISP or other devices using a coaxial cable.

Power Port

The Power port connects the FiOS Router to an electrical wall outlet via the Power cord.

Power Switch

The Power switch powers the FiOS Router on and off.

Reset Button

To restore the FiOS Router's factory default settings, press and hold the Reset button for approximately ten seconds. The reset process will start about ten seconds after releasing the button. When the FiOS Router resets, all the lights on the front panel turn off, and then some of the lights start flashing. The FiOS Router has completed its reset process when the Power light glows steadily green.

Caution! Do not unplug the Power cord from the FiOS Router during the reset process. Doing so may result in the loss of the FiOS Router's configuration information. If this occurs, reset the FiOS Router again.

LAN Ethernet Ports (4)

The LAN Ethernet ports connect devices to the FiOS Router via Ethernet cables to create a local area network (LAN). The LAN Ethernet ports are 10/100/1000 Mbps auto-sensing ports, and either a straight-through or crossover Ethernet cable can be used when connecting devices to the ports.

WAN Ethernet Port

The WAN Ethernet port connects the FiOS Router to the ISP using an Ethernet cable.

USB Ports

The USB ports provide up to 500 mA at 5 VDC for attached devices (to charge a cell phone, for example). In the future, with a firmware release upgrade, the USB host functionality will be available for devices such as external storage and cameras.

Wireless Antenna

The FiOS Router's wireless antenna is used to transmit a wireless signal to other wireless devices on its wireless network.

2

- 2.0** Introduction
- 2.1** Setting up the FiOS Router
- 2.2** Computer Network Configuration
- 2.3** Configuring the FiOS Router
- 2.4** Main Screen

Connecting the FiOS Router

Connecting the FiOS Router and accessing its Graphical User Interface (GUI) are both simple procedures. The latter procedure may vary slightly, depending on the computer's operating system. However, no configuration is necessary to access the GUI when taking advantage of Universal Plug-and-Play support.

2.1 Setting Up the FiOS Router

There are three parts to setting up the FiOS Router: **Connecting the Cables**, **Configuring the Router**, and **Connecting Other Computers/Set Top Boxes**.

2.1a Connecting the Cables

Note: If a different router was being used previously, disconnect it. Remove all router components, including power supplies and cables, as they will not work with the FiOS Router.

1. Get the FiOS Router and black Power cord from the box.
2. Plug the black Power cord in the black port on the back of the FiOS Router and then into a power outlet.
3. Turn the FiOS Router on.
4. The Power light on the front of the FiOS Router will glow red for approximately 1 minute during initialization; wait until the Power light glows steadily green before proceeding to step 5.
5. Plug the yellow Ethernet cable from the box into one of the four yellow Ethernet ports on the back of the FiOS Router.
6. Make sure the computer is powered on, then plug the other end of the yellow Ethernet cable into an Ethernet port on the computer.
7. Make sure at least one of the Ethernet LAN lights on the front of the FiOS Router glows steadily green. This may take a few moments.
8. The phone company previously installed a high-speed wall jack somewhere in the house. Locate it and note its type (Ethernet or coaxial). If Ethernet, follow steps 8a and 8b. If coaxial, follow steps 9a and 9b. Then, continue to step 10.
 - a. If connecting via Ethernet, get the white Ethernet cable from the box and plug one end in the white port on the back of the FiOS Router.
 - b. Plug the other end of the white Ethernet cable into the high-speed Ethernet jack.

9.
 - a. If connecting via coaxial cable, get a coaxial cable and connect one end to the red Coax port on the back of the FiOS Router.
 - b. Connect the other end of the coaxial cable to a coax jack.
10. Make sure the Ethernet WAN light (if connecting via Ethernet) or Coax WAN light (if connecting via coaxial cable) on the front of the FiOS Router glows steadily green. If connecting via coaxial cable, this may take a few minutes.

Note: If the Ethernet WAN light or Coax WAN light does not illuminate, make sure the cable (Ethernet or coaxial) is connected properly at both ends.

2.2 Computer Network Configuration

Each network interface on the computer should either be configured with a statically defined IP address and DNS address, or instructed to automatically obtain an IP address using the Network DHCP server. The FiOS Router is set up, by default, with an active DHCP server, and we recommend leaving this setting as is.

2.2a Configuring Dynamic IP Addressing

To set up a computer to use dynamic IP addressing:

Windows 7

1. In the Control Panel, select **View Network Status and Tasks** (below "Network and Internet").
2. Under "Connect or disconnect," click **Local Access Connection**.
3. The "Local Area Connection Status" window appears. Click **Properties**.
4. The "Local Area Connection Properties" window appears. Select **Internet Protocol Version 4 (TCP/IPv4)**, then click **Properties**.
5. The "Internet Protocol Version 4 (TCP/IPv4) Properties" window appears.
6. Click the "Obtain an IP address automatically" radio button.
7. Click the "Obtain DNS server address automatically" radio button.
8. Click **OK** in the Internet Protocol Version 4(TCP/IPv4) Properties window, then click **OK** in the Local Area Connection Properties screen to save the settings.

Windows Vista

1. Select **Network and Sharing** in the Control Panel.
2. Click **View Status**, then click **Properties**.
3. Click **Continue** in the “User Account Control” window.
4. In the “General” tab of the “Local Area Connection Properties” window select **Internet Protocol Version 4 (TCP/IPv4)**, then click **Properties**.
5. The “Internet Protocol Version 4 (TCP/IPv4) Properties” window appears.
6. Click the “Obtain an IP address automatically” radio button.
7. Click the “Obtain DNS server address automatically” radio button.
8. Click **OK** in the Internet Protocol Version 4(TCP/IPv4) Properties window, then click **OK** in the “Local Area Connection Properties” screen to save the settings.

Windows XP

1. Select **Network Connections** in the Control Panel.
2. Right-click **Ethernet Local Area Connection**, then click **Properties**.
3. In the “General” tab, select **Internet Protocol (TCP/IP)**, then click **Properties**.
4. The “Internet Protocol (TCP/IP) Properties” window appears.
5. Click the “Obtain an IP address automatically” radio button.
6. Click the “Obtain DNS server address automatically” radio button.
7. Click **OK** in the “Internet Protocol (TCP/IP) Properties” screen, then click **OK** in the “Local Area Connection Properties” screen to save the settings.

Macintosh OS X

1. Click on the Apple icon in the top left corner of the desktop.
2. From the menu that appears, select **System Preferences**.
3. The "System Preferences" window appears. Click **Network**.
4. From the "Network" window, make sure "Ethernet" in the list on the left is highlighted and displays "Connected."
5. Click **Assist me**.
6. From the tab that appears, click **Diagnostics**.
7. Follow the instructions in the "Network Diagnostics" assistant.

Linux

1. Login into the system as a super-user by entering "su" at the prompt.
2. Type "ifconfig" to display the network devices and allocated IPs.
3. Type "pump -i <dev>," where <dev> is the network device name.
4. Type "ifconfig" again to view the newly allocated IP address.
5. Make sure no firewall is active on device <dev>.

2 Connecting the FiOS Router

2.3 Configuring the FiOS Router

2.3 Configuring the FiOS Router

1. Open a web browser on the computer connected to the FiOS Router. In the “Address” text box, type:
http://192.168.1.1
then press **Enter** on the keyboard.

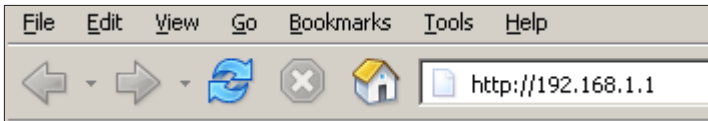

2. The “Login” screen appears. Enter “admin” in the “User Name” text box. Enter the password that is printed next to “Default Password” on the label attached to the bottom of the FiOS Router in the “Password” text box.

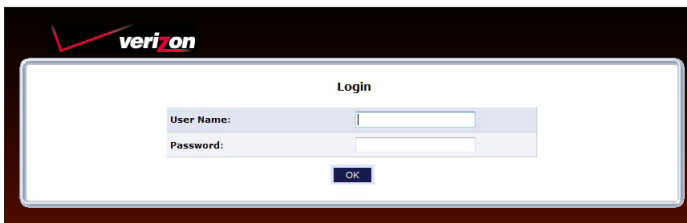

3. Click **OK**.

The FiOS Router is now configured. The password can be changed after this initial log in, but if the FiOS Router is subsequently reset to factory default settings, the password printed on the label will be in effect.

2.3a Connecting Other Computers/Set Top Boxes

The FiOS Router can connect to other computers or set top boxes in three ways: via Ethernet, via wireless connection, or via coaxial cable.

Ethernet

1. Get an Ethernet cable and plug one end into one of the open yellow Ethernet ports on the back of the FiOS Router.
2. Plug the other end of the Ethernet cable into an Ethernet port on the computer.
3. Make sure the corresponding Ethernet LAN light on the front of the FiOS Router glows steadily green.
4. Repeat these steps for each computer to be connected to the FiOS Router via Ethernet.

Wireless

1. Make sure each computer to be connected wirelessly has built-in wireless or an attached wireless adapter.
2. Make sure the computer uses the same ESSID and WPA2 key as the FiOS Router by launching the computer's wireless application
3. Enter the ESSID and WPA2 key found on the sticker on the bottom of the FiOS Router in the computer's wireless settings and click **Save**.
4. Make sure the changes were implemented by surfing the Internet from the computer.
5. Repeat these steps for every other computer to be connected to the FiOS Router wirelessly.

2 Connecting the FiOS Router

2.4 Main Screen

Coaxial

1. Make sure all set top boxes are turned off.
2. Disconnect any adapter currently connected to the coaxial jack in the room where the FiOS Router is.
3. Connect one end of the coaxial cable to the coaxial wall jack, and the other end to the red Coax port on the back of the FiOS Router.
4. Power up the set top box.
5. Make sure the Coax LAN light on the front of the FiOS Router glows steadily green. This may take a few minutes. When it does, the set top box is connected to the FiOS Router.

2.4 Main Screen

After logging into the FiOS Router's GUI (see "Configuring the FiOS Router" at the beginning of this chapter), the "Main" screen appears.

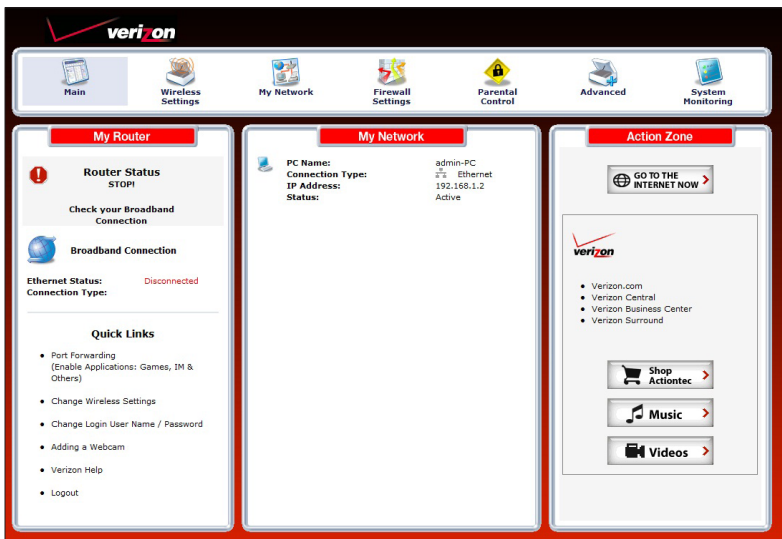

The Main screen has a menu occupying the top of the screen. Below that, the screen is divided into three columns: "My Router," "My Network," and "Action Zone."

2.4a Menu

The Main screen's menu contains links to all of the configuration options of the FiOS Router: **Wireless Settings** (explained in chapter 3 of this manual), **My Network** (chapter 5), **Firewall Settings** (chapter 6), **Parental Controls** (chapter 7), **Advanced** (chapter 8), and **System Monitoring** (chapter 9).

2.4b My Router

This section displays the status of the FiOS Router's network and Internet connection.

Broadband Connection

The "Broadband Connection" section of the My Router column displays the state of the FiOS Router's broadband connection ("Connected" or "Disconnected") for the two connection options ("Coax Status" and "Ethernet Status"), and the WAN IP address of the broadband connection.

Quick Links

The "Quick Links" section of the My Router column contains a list of frequently accessed settings, including "Port Forwarding," "Change Wireless Settings," "Change Login User Name/Password," "Adding a Webcam," "Verizon Help" and "Logout."

2 Connecting the FiOS Router

2.4 Main Screen

2.4c My Network

The “My Network” column of the Main screen displays the connection type, name, and IP address of all devices connected to the FiOS Router’s network. The icon associated with the device will be displayed normally (signifying an active device) or shaded (signifying the device has not been active for at least 60 seconds). The user can view the settings of each device by clicking on its icon.

2.4d Action Zone

This column contains links to various Verizon Web sites, and other informational links. Clicking on the icon above “Go to Internet Now” connects the user to the home page configured on the user’s web browser.

3

- 3.0** Introduction
- 3.1** Overview
- 3.2** Connecting a Wireless Client
- 3.3** Wireless Status
- 3.4** Basic Security Settings
- 3.5** Advanced Security Settings
- 3.6** Setting Up a Wireless Client

Setting Up a Wireless Network

Wireless networking enables you to free yourself from wires and plugs, making your devices more accessible and easier to use. This chapter explains how to create a wireless network using the FiOS Router, including accessing and configuring wireless security options.

3.1 Overview

The FiOS Router provides the user with wireless connectivity over the 802.11b, g, and n standards (the most common wireless standards). 802.11b has a maximum data rate of 11 Mbps, 802.11g has a maximum data rate of 54 Mbps, and 802.11n has a maximum data rate of 160 Mbps. All standards operate in the 2.4 GHz range.

The FiOS Router's wireless feature is turned on, with wireless security activated, by default. The level of security is WPA2, with a unique WPA2 key already entered. This information is displayed on a sticker located on the bottom of the FiOS Router.

The FiOS Router integrates multiple layers of security. These include the IEEE 802.1x port-based authentication protocol, RADIUS client, EAP-MD5, EAP-TLS, EAP-TTLS, EAP-PEAP, Wired Equivalent Privacy (WEP), Wi-Fi Protected Access (WPA and WPA2) and firewall and VPN applications.

3.2 Connecting a Wireless Client

To connect a wireless client to the FiOS Router:

Note: The following procedure assumes the FiOS Router's default wireless settings are intact. If they have been changed, use the new ESSID and wireless security settings. For more details, see the "Setting Up a Wireless Client" section of this chapter.

1. In the wireless client's configuration interface, enter the FiOS Router's ESSID (found on a sticker on the bottom of the FiOS Router's case) in the appropriate text box or field (this varies depending on the wireless client's manufacturer).
2. Enter the FiOS Router's wireless key (also found on the sticker on the bottom of the FiOS Router's case) in the wireless client's configuration interface.
3. Save the changes and exit the wireless client's configuration interface. The client should now detect and join the FiOS Router's wireless network. If not, check the wireless client's documentation, or contact its manufacturer.

3.3 Wireless Status

Clicking on the “Wireless Settings” icon from the Main screen’s menu generates the “Wireless Status” screen, which displays the current status of the wireless connection.

Wireless Status	
Radio Enabled:	Yes
SSID:	XFAZ4
Channel:	Automatic
Security Enabled:	Yes
WEP 64-bit:	N/A
WEP 802.1x:	N/A
WPA2:	c475b6d8bdf49b0f64de8102a
SSID Broadcast:	Enabled
MAC Authentication:	Disabled
Wireless Mode:	Compatibility Mode(802.11b/g/n)
WMM:	Enabled
Received Packets:	0
Sent Packets:	109

3.3a Radio Enabled

Displays whether the FiOS Router’s wireless radio is active.

3.3b SSID

The SSID (Service Set Identifier) is the network name shared among all devices on a particular wireless network. The SSID must be identical for all devices on the wireless network. It is case-sensitive and cannot exceed 32 characters. Make sure the SSID is the same for all devices to be connected to the wireless network. The FiOS Router comes from the factory with an SSID already entered and displayed here. The default SSID can also be found on a sticker on the bottom of the FiOS Router.

3.3c Channel

Displays the channel to which the wireless connection is currently set. All devices on the wireless network must be on the same channel to function correctly.

3.3d Security Enabled

Displays what kind of security is active on the wireless connection, and the security encryption key.

3.3e SSID Broadcast

Displays whether the FiOS Router is broadcasting its SSID. If activated, the SSID of the FiOS Router's wireless network is broadcast wirelessly.

3.3f MAC Authentication

Displays whether the FiOS Router is using MAC (Media Access Control) address authentication to allow wireless devices to join the network.

3.3g Wireless Mode

Displays the types of wireless device that can join the network. Options include 802.11b, 802.11g, 802.11 n, or Mixed (allows 802.11b-, 802.11g-, and 802.11n-equipped wireless devices to join the network).

3.3h WMM

Displays whether WMM is enabled on the FiOS Router.

3.3i Packets Received/Sent

Displays the number of packets received and sent since the FiOS Router's wireless capability was activated.

3.4 Basic Security Settings

To configure the FiOS Router's wireless network for basic security, select "Basic Security Settings" from the menu on the left side of any Wireless Settings screen. The "Basic Security Settings" screen appears.

Note: The FiOS Router's default wireless security is WPA2. This section explains how to activate WEP wireless security, which is a less robust security than WPA2. To set up WPA2 wireless security, see "WPA2" on page 38.

Basic Security Settings

Instructions for setting up a wireless network using basic WEP wireless security are set out below. However, we recommend that you establish stronger security using the Advanced Security Settings. To establish stronger security, select "OFF" in Step 4, click on APPLY and then go to Advanced Security Settings to setup security.

1. Turn Wireless ON

Wireless: On Off

2. Change the SSID setting to any name or code you want
(SSID is the same thing as the name of your Wireless Network.)

SSID:

3. Channel

To change the channel of the frequency band at which the Router communicates, please enter it below. Then click apply to save your settings:

NOTE: In the United States, use channels 1-11.

Channel:

Keep my channel selection during power cycle.

4. Click on the button next to WEP

WEP prevents unintentional connections to your wireless home network. For greater protection against hacking and security breaches, see Advanced Security Settings.

WEP Off

1. Click the "On" radio button to activate the FiOS Router's wireless radio.
2. Enter the name of the wireless network in the "SSID" text box (the SSID name in the figure above is an example; enter a different name for the SSID).
3. Select the channel at which the FiOS Router's wireless radio communicates by selecting it from the "Channel" drop-down list.
4. To preserve the channel selection in the event of a FiOS Router power cycle, click in the box next to "Keep my channel selection during power cycle."

5. Click the “WEP” radio button to activate WEP (Wired Equivalent Privacy) security on the wireless network.
6. Select a WEP security level from the “select a WEP Key” drop-down list (options include “64/40 bit” or “128/104 bit”).
7. Enter the key code in the “Key Code” text box. Each character must be a letter from A-F or a number from 0-9. If 64/40 bit was selected in step 5, enter 10 characters. If 128/104 was selected, enter 26 characters.
8. Write down the wireless settings displayed on the screen. Other wireless devices must use these same settings when configuring the device’s wireless networking scheme to join the FiOS Router’s wireless network.
9. Click **Apply** to save the settings.

5. Select a WEP Key

NOTE: - To create a 64/40 WEP Hex Key, you need to enter a combination of 10 digits. You can choose any letter from A-F or any number from 0-9. Sample HEX WEP Key: 0FB310FF2E.
 - To create a 64/40 WEP ASCII, you need to enter a combination of 5 ASCII characters. Sample ASCII WEP Key: hello.

Select a WEP Key:

Key Code: 0 Digits left

6. Write down wireless settings.

In order for every computer to connect to this Router wirelessly, you need to make sure that the wireless setup for each computer uses the SAME settings listed below. Please make sure that you write down all of the values set on this screen.

Current Wireless Status:

Wireless:	ON
SSID:	RTL6
64-BIT WEP:	ON
64-BIT WEP KEY:	14ED82A9DB
Channel:	Automatic
SSID Broadcast:	Enabled
MAC Authentication:	Disabled
Wireless Mode:	Compatibility Mode(802.11b/g/n)
Packets Sent:	400
Packets Received:	0

3.5 Advanced Security Settings

To configure the FiOS Router's advanced wireless network security settings, select "Advanced Security Settings" from the menu on the left side of any Wireless Settings screen. The "Advanced Security Settings" screen appears.

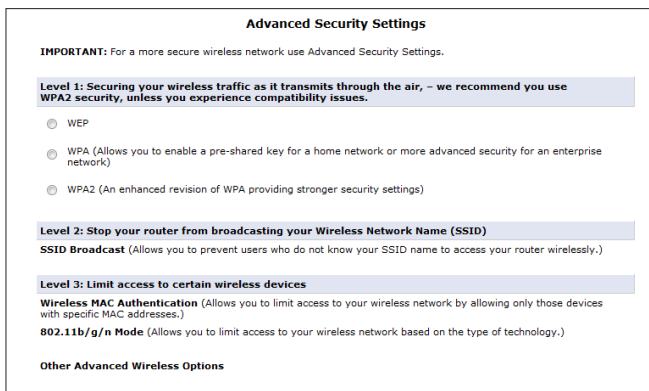

3.5a Level 1 (Wireless Security)

This section is used to configure different types of wireless security. Select the type of wireless security to be applied to the wireless network by clicking the appropriate radio button, then configure the security settings in the subsequent screens.

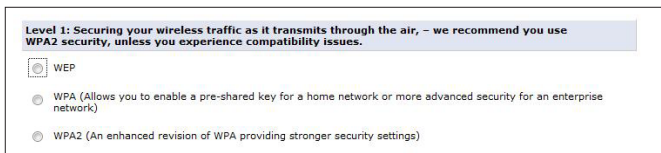

WEP

If WEP was selected in the Advanced Security Settings screen, the “WEP” screen appears.

WEP

WEP Mode: WEP Only ▾

Network Authentication: Open System Authentication ▾

WEP Keys			
Active	Encryption Key	Entry Method	Key Length
<input checked="" type="radio"/> 1	C005675C1F	Hex ▾	64/40 bit ▾
<input type="radio"/> 2		Hex ▾	64/40 bit ▾
<input type="radio"/> 3		Hex ▾	64/40 bit ▾
<input type="radio"/> 4		Hex ▾	64/40 bit ▾

Back
Apply

1. Select the appropriate WEP mode from the drop-down list. Options include WEP Only, or 802.1x. If selecting the latter, see the “802.1x” section on the next page.
2. Select the appropriate network authentication level from the drop-down list. Options include Open System Authentication, Shared Key Authentication, or Both.
3. Activate WEP key 1 by clicking the radio button next to “1” on the left side.
4. Select the length of key 1 by selecting “64/40 bit” or “128/104 bit” from the appropriate drop-down list in the “Key Length” column.
5. Select the type of key from the appropriate drop-down list in the “Entry Method” column. If “Hex” is selected, the key must be made up of hexadecimal digits. If “ASCII” is selected, the key can be made up of any characters.
6. Enter the key in the appropriate text box in the “Encryption Key” column. If 64/40 bit was chosen in step 2, enter 10 characters. If 128/104 bit was chosen, enter 24 characters. Depending on what option was selected in step 3, enter hexadecimal or ASCII characters.
7. Click **Apply** to save changes.

802.1x

If 802.1x was selected in step 1 of the previous procedure, another screen appears, relating to settings for 802.1x WEP.



WEP	
WEP Mode:	802.1X
Server IP:	0 0 0 0
Server Port:	1812
Shared Secret:	
Back Apply	

802.1x WEP is a robust security protocol that uses port control with dynamically changing encryption keys automatically updated over the network. 802.1x WEP uses a RADIUS (Remote Authentication Dial-in Service) server for authentication purposes. This server must be physically connected to the FiOS Router. Also, the user must enable the RADIUS client embedded in the FiOS Router (to do this, see chapter 8, “Advanced Settings”).

1. Select the WEP Mode from the “WEP Mode” drop-down list box.
2. Enter the RADIUS server IP address in the “Server IP” text boxes.
3. Enter the RADIUS server’s port number in the “Server Port” text box.
4. Enter the RADIUS server’s shared secret in the “Shared Secret” text box.
5. Click **Apply** to save changes.

WPA

If WPA (Wi-Fi Protected Access) was selected, the “WPA Key” screen appears.

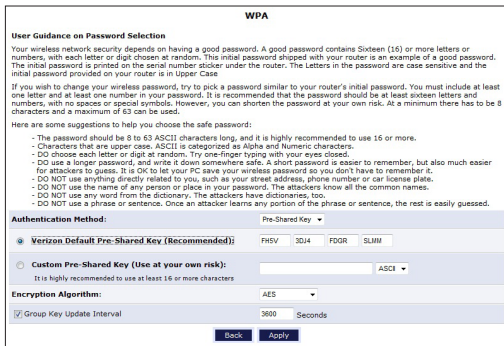

1. Review the onscreen guide, “User Guidance on Password Selection.”
2. Make sure the radio button next to “Verizon Default Pre-Shared Key (Recommended)” is activated (blue). If not, click the button to activate.
3. Write the default pre-shared key down and keep it in a secure place.
4. Select the proper encryption algorithm (TKIP, AES, or TKIP+AES).
5. Click in the “Group Key Update Interval” check box to activate the group key update interval, and set the interval time in the text box to the right.
6. Click **Apply** at the bottom of the screen to save changes.

3 Setting Up a Wireless Network

3.5 Advanced Security Settings

WPA2

If WPA2 was selected, the “WPA2” screen appears. Note that WPA2 is the FiOS Router’s default wireless security protocol.

WPA2

User Guidance on Password Selection

Your wireless network security depends on having a good password. A good password contains Sixteen (16) or more letters or numbers, with each letter or digit chosen at random. This initial password shipped with your router is an example of a good password. The initial password is printed on the serial number sticker under the router. The letters in the password are case sensitive and the initial password provided on your router is in Upper Case

If you wish to change your wireless password, try to pick a password similar to your router’s initial password. You must include at least one letter and at least one number in your password. It is recommended that the password should be at least sixteen letters and numbers, with no spaces or special symbols. However, you can shorten the password at your own risk. At a minimum there has to be 8 characters and a maximum of 63 can be used.

Here are some suggestions to help you choose the safe password:

- The password should be 8 to 63 ASCII characters long, and it is highly recommended to use 16 or more.
- Characters that are upper case, ASCII is categorized as Alpha and Numeric characters.
- DO choose each letter or digit at random. Try one-finger typing with your eyes closed.
- DO use a longer password, and write it down somewhere safe. A short password is easier to remember, but also much easier for attackers to guess. It is OK to let your PC save your wireless password so you don’t have to remember it.
- DO NOT use anything directly related to you, such as your street address, phone number or car license plate.
- DO NOT use the name of any person or place in your password. The attackers know all the common names.
- DO NOT use any word from the dictionary. The attackers have dictionaries, too.
- DO NOT use a phrase or sentence. Once an attacker learns any portion of the phrase or sentence, the rest is easily guessed.

Authentication Method: Pre-Shared Key ▾

Verizon Default Pre-Shared Key (Recommended): FHSV 3DJA FDOR SLMM

Custom Pre-Shared Key (Use at your own risk): _____ ASCII ▾
It is highly recommended to use at least 16 or more characters

Encryption Algorithm: AES ▾

Group Key Update Interval 3600 Seconds

1. Review the onscreen guide, “User Guidance on Password Selection.”
2. Make sure the radio button next to “Verizon Default Pre-Shared Key (Recommended)” is activated (blue). If not, click the button to activate.
3. Write the default pre-shared key down and keep it in a secure place.
4. Select the proper encryption algorithm (TKIP, AES, or TKIP+AES).
5. Click in the “Group Key Update Interval” check box to activate the group key update interval, and set the interval time in the text box to the right.
6. Click **Apply** at the bottom of the screen to save changes.

3.5b Level 2 (SSID Broadcast)

This section is used to configure the FiOS Router's SSID broadcast capabilities. Enabling this option allows any wireless device using an SSID of "Any" to detect the FiOS Router's wireless network. Disabling "SSID Broadcast" allows only those wireless users who know the SSID of the wireless network to detect and connect to the network.

Level 2: Stop your router from broadcasting your Wireless Network Name (SSID)

SSID Broadcast (Allows you to prevent users who do not know your SSID name to access your router wirelessly.)

Selecting "SSID Broadcast" generates the "SSID Broadcast" screen.

SSID Broadcast

When SSID Broadcast is enabled, it means that any computer or wireless device using the SSID of "Any" can see your Router. To prevent this from happening, disable the SSID broadcast so that only those Wireless devices with your SSID can access your Router.

Enable Disable

[Back](#) [Apply](#)

Click the "Enable" radio button to enable SSID broadcasting. If enabled, the SSID of the FiOS Router's wireless network will be broadcast wirelessly. To disable SSID broadcasting, click the "Disable" radio button.

3 Setting Up a Wireless Network

3.5 Advanced Security Settings

3.5c Level 3 (Limiting Access)

This option is used to limit access to the FiOS Router's wireless network.

Level 3: Limit access to certain wireless devices

Wireless MAC Authentication (Allows you to limit access to your wireless network by allowing only those devices with specific MAC addresses.)

802.11b/g/n Mode (Allows you to limit access to your wireless network based on the type of technology.)

Wireless MAC Authentication

Wireless MAC authentication allows the user to allow or deny access to the FiOS Router's wireless network by a particular device's MAC address. Selecting "Wireless MAC Authentication" from the Advanced Security Settings screen generates the "Wireless MAC Authentication" screen.

Wireless MAC Authentication

To limit access to this Router using the MAC address of specific wireless devices, please follow the instructions below.

1. Click the box next to 'Enable Access List'

If you want to limit access to a certain list of wireless devices:

2. Click the box next to 'Accept all devices listed below'
3. Enter the MAC Address of first Wireless device and then click Add.
4. Repeat the process for each Wireless device that you want to have access to the network.
5. Verify that all devices were entered properly by reviewing the list at the bottom.
6. Click Apply to save your settings.

If you want to allow access to any wireless device except for a certain group:

7. Click the box next to 'Deny all devices listed below'.
8. Enter the MAC Address of first Wireless device that you want denied and then click Add.
9. Repeat the process for each Wireless device that you do NOT want to have access to the network.
10. Verify that all devices were entered properly by reviewing the list at the bottom.
11. Click Apply to save your settings.

Enable Access List

Accept all devices listed below Deny all devices listed below

Client MAC address:

Sample MAC Address: 00:20:e0:00:41:00

List:

To set up wireless MAC authentication:

1. Click in the "Enable Access List" check box.
2. Select either "Accept all devices listed below" or "Deny all devices listed below" by clicking the appropriate radio button. Selecting "Accept..." causes all devices listed by MAC address to access the FiOS Router's wireless network. Selecting "Deny..." causes all listed devices to be denied access.
3. Enter the MAC address of a device in the "Client MAC address" text box.
4. Click **Add**.
5. Repeat steps 3 and 4 to add more devices to the list.
6. When finished listing devices, click **Apply**.

To remove a MAC address, select it from the "List" list box, then click **Remove**.

802.11b/g/n Mode

This option allows the user to select the wireless communication standard compatible with the devices to be connected on the wireless network from the drop-down list. Options include Compatibility (802.11b, g, and n devices can connect) Legacy (only 802.11b and g devices can connect), and Performance (only 802.11n devices can join).

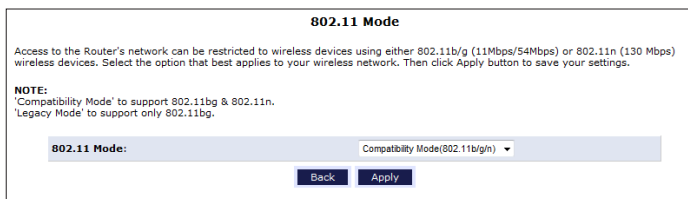

3 Setting Up a Wireless Network

3.5 Advanced Security Settings

3.5d Other Advanced Wireless Options

Clicking **Other Advanced Wireless Options** at the bottom of the Advanced Security Settings screen generates (after clicking through the “Warning” screen) another “Advanced Wireless Options” screen.

The screenshot shows the "Advanced Wireless Options" configuration screen. It contains the following settings:

Advanced Wireless Options	
Transmission Rate:	Auto
Transmit Power:	100 %
CTS Protection Mode:	None
CTS Protection Type:	cts-only
Frame Burst - Max Number:	3
Frame Burst - Burst Time:	2
Beacon Interval:	100 ms
DTIM Interval:	1 ms
Fragmentation Threshold:	2346
RTS Threshold:	2346
MSDU Aggregation:	<input type="radio"/> Enable <input checked="" type="radio"/> Disable
MPDU Aggregation:	<input checked="" type="radio"/> Enable <input type="radio"/> Disable
802.11n Guard Interval:	Dynamic
WMM Settings	
<input type="button" value="Back"/> <input type="button" value="Apply"/>	

Transmission Rate

Always set to “Auto.”

Transmit Power

Adjust the power of the FiOS Router’s wireless signal by entering a percentage in this text box.

CTS Protection Mode

Activating CTS (Clear to Send) Protection Mode allows mixed 802.11b/g/n networks to operate at maximum efficiency. Select **Auto** from the drop-down list to activate. Select **None** to deactivate .

CTS Protection Type

Select from the two options: **cts-only** (for mixed 802.11b/g/n networks) or **rts-cts** (for 802.11a/b/g networks).

Frame Burst - Max Number

Frame Burst allows packet bursting, which increases overall network speed. Enter the maximum number of frame bursts in this text box.

Frame Burst - Burst Time

Enter the burst time of the frame bursts in this text box.

Beacon Interval

Enter the time period of the beacon interval in this text box.

DTIM Interval

Enter the DTIM (Delivery Traffic Indication Message) interval value (in milliseconds) in this text box. A DTIM is a countdown mechanism for the FiOS Router, informing wireless network clients of the next window for listening to broadcast and multicast messages.

Fragmentation Threshold

Setting the correct fragmentation threshold can increase the reliability of frame transmissions on the wireless network. Enter the fragmentation threshold in this text box.

RTS Threshold

Enter the RTS (Request to Send) threshold in this text box. This setting controls what size data packet the low level RF protocol issues to an RTS packet.

MSDU Aggregation

Use these radio buttons to enable or disable MSDU aggregation.

MPDU Aggregation

Use these radio buttons to enable or disable MPDU aggregation.

3 Setting Up a Wireless Network

3.5 Advanced Security Settings

802.11 Guard Interval

Always set to “Dynamic.”

3.5e WMM Settings

Clicking **WMM Settings** at the bottom of the Advanced Wireless Options screen generates (after clicking through the “Warning” screen) the “Wireless QoS (WMM)” screen. This screen allows the user to prioritize the types of data coming over the FiOS Router’s wireless network.

Wireless QoS (WMM)

Wireless QoS (WMM): Enabled

WMM Power Save: Enabled

ID	Tag	Priority	Action
0	DSCP Best Effort - 0x00	WMM AC Best Effort - 0	⬇️ ⬆️ ⬇️ ⬇️
1	DSCP Background - 0x08	WMM AC Background - 1	⬆️ ⬇️ ⬆️ ⬇️ ⬇️ ⬇️
2	DSCP Excellent Effort - 0x18	WMM AC Best Effort - 0	⬆️ ⬆️ ⬆️ ⬆️ ⬆️ ⬆️ ⬆️ ⬆️
3	DSCP Video - 0x28	WMM AC Video - 2	⬆️ ⬆️ ⬆️ ⬆️ ⬆️ ⬆️ ⬆️ ⬆️
4	DSCP Audio - 0x38	WMM AC Voice - 3	⬆️ ⬆️ ⬆️ ⬆️ ⬆️ ⬆️ ⬆️ ⬆️
Add			➕

Priority	Admission Control Mandatory	Quota
WMM AC Voice - 3	No ▾	0
WMM AC Video - 2	No ▾	0
WMM AC Best Effort - 0	No ▾	0

Wireless QoS (WMM)

Click in the check box to enable/disable Wireless QoS.

WMM Power Save

Click in the check box to enable/disable WMM Power Save.

Priority Table

The upper table in the Wireless QoS screen is the Priority Table.

ID	Tag	Priority	Action
0	DSCP Best Effort - 0x00	WMM AC Best Effort - 0	
1	DSCP Background - 0x08	WMM AC Background - 1	
2	DSCP Excellent Effort - 0x18	WMM AC Best Effort - 0	
3	DSCP Video - 0x28	WMM AC Video - 2	
4	DSCP Audio - 0x38	WMM AC Voice - 3	
Add			

Use the green up and down arrows to adjust the priority of a particular type of wireless data. The data type at the top of the table has the highest priority on the wireless network; at the bottom is the lowest. Additionally, the user can add a custom type of data by clicking **Add** and, in the screen that appears, creating a new type of data tag. Finally, clicking the Action icon in the row corresponding to an existing type of data allows the user to modify that type of data's Tag and WMM access.

Admission Control Table

The lower table in the Wireless QoS screen is the Admission Control Table.

Priority	Admission Control Mandatory	Quota
WMM AC Voice - 3	No <input type="button" value="v"/>	0 <input type="text"/>
WMM AC Video - 2	No <input type="button" value="v"/>	0 <input type="text"/>
WMM AC Best Effort - 0	No <input type="button" value="v"/>	0 <input type="text"/>

This table allows the user to adjust a wireless data type's admission control by selecting Yes/No from the corresponding row's drop-down list. Also, if needed, enter a Quota amount in the appropriate Quota text box.

3.6 Setting Up a Wireless Client

If the computer has wireless capabilities and is running Windows XP, Vista, or 7, it will automatically recognize the existing wireless network and try to create a wireless connection. View this connection under Windows' "Network Connections."

3.6a Setting Up a Wireless Windows Client (Windows 7)

If the computer has wireless capabilities and is running Windows 7, it will automatically recognize the existing wireless network and try to create a wireless connection. To manually connect to a wireless network:

1. Click the wireless icon the system tray (in the lower right corner of the desktop) and, from the menu that appears, click the FiOS Router's wireless network name from the list.

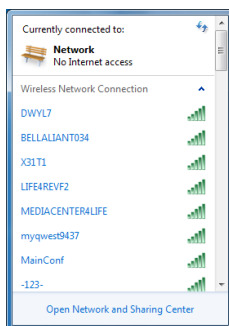

- When the “Connect” button appears under the network’s name, click on it.



- A “Connect to a Network” window appears. Enter the security key of the wireless network in the appropriate text box, then click OK.

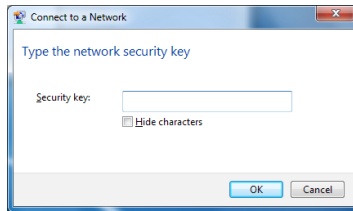

3 Setting Up a Wireless Network

3.6 Setting Up a Wireless Client

- The connection is made. To check the status of the connection, click on the wireless icon in the service tray again. In the example, the computer has successfully joined the wireless network “DWYL7.”

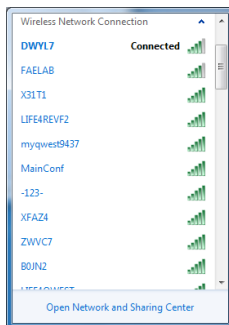

3.6b Setting Up a Wireless Windows Client (Windows Vista)

If the computer has wireless capabilities and is running Windows Vista, it will automatically recognize the existing wireless network and try to create a wireless connection. View this connection under Windows “Network Connections.”

- Click the wireless icon the system tray (in the lower right corner of the desktop) and, from the menu that appears, select **Connect to a Network**.
- A “Connect to a Network” window appears. Select the FiOS Router’s wireless network.

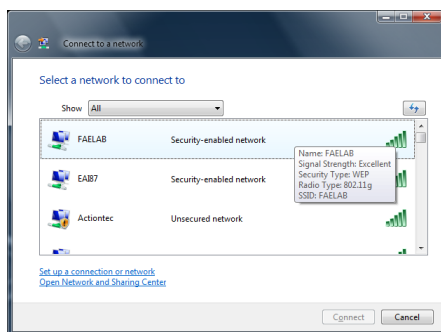

3. Another Connect to a Network window appears. Enter the WPA key of the network in the appropriate text box.

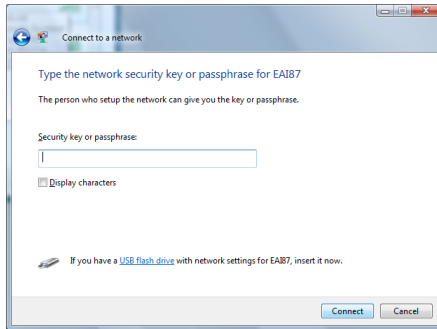

4. Click **Connect**. A third Connect to a Network window appears, stating that the connection was successful.

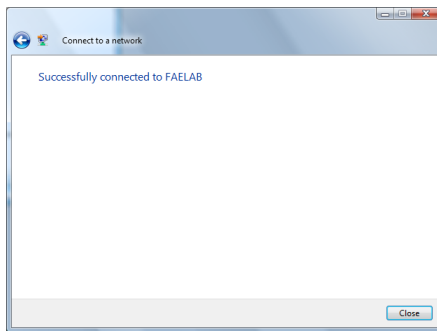

3 Setting Up a Wireless Network

3.6 Setting Up a Wireless Client

3.6c Setting Up a Wireless Windows Client (Windows XP)

This section assumes the FiOS Router's wireless network is set up with WPA security.

1. Click **Network Connections** in the Control Panel. The "Network Connections" window appears.

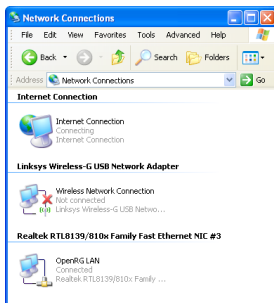

2. Double-click the wireless connection icon. The "Wireless Network Connection" screen appears, displaying the available wireless connections. Select the FiOS Router's network.

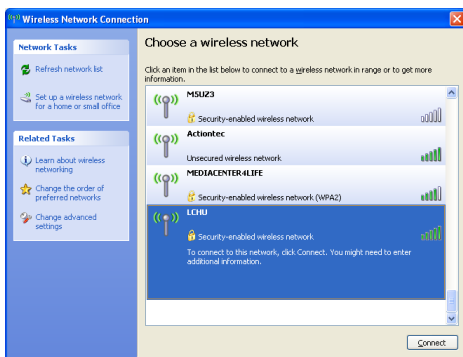

- Click the connection once to mark it, then click **Connect** at the bottom of the screen. The following login window appears, asking for a “Network Key,” which is the pre-shared key used when configuring the FiOS Router’s WPA security (see the “WPA” section in this chapter).

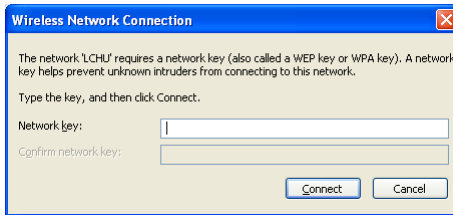

- Enter the network (WPA) key in both text boxes and click **Connect**. After the connection is established, its status will change to “Connected,” as shown below.

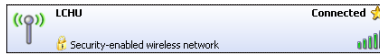

An icon appears in the notification area, announcing the successful initiation of the wireless connection.

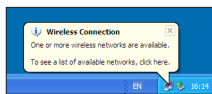

- Test the connection by disabling all other connections in the Network Connections window and surfing the Internet.

3 Setting Up a Wireless Network

3.6 Setting Up a Wireless Client

Manual Wireless Network Connection

If the login window shown in step 3 does not appear and the connection attempt fails, configure the connection manually using the following procedure:

1. Click the connection once to mark it and then click **Change Advanced Settings** in the “Related Tasks” box on the left part of the window.

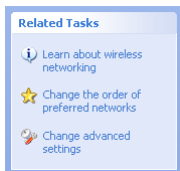

2. The “Wireless Network Connection Properties” window appears. Select **Wireless Networks**.

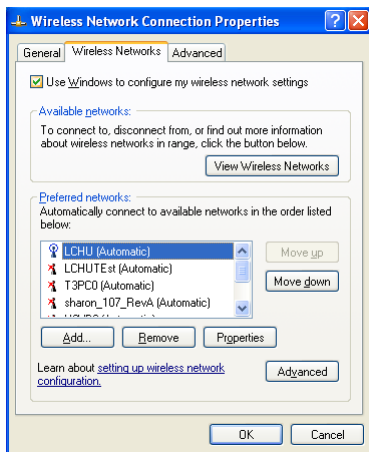

- Click the connection to highlight it, then click **Properties**. The connection's "Properties Window" appears.

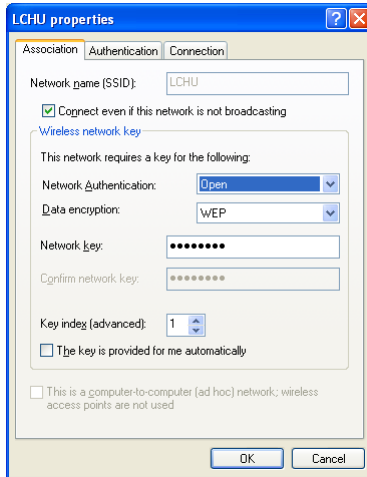

- From the "Network Authentication" drop-down list, select "Open."
- From the "Data Encryption" drop-down list, select "WPA."
- Enter the pre-shared key in both the "Network key" and the "Confirm network key" text boxes.
- Click **OK**, then **OK** again.
- When attempting to connect to the wireless network, the login window appears, pre-populated with the pre-shared key. Press **Connect** to connect.

Since the network is now secured, only users who know the pre-shared key will be able to connect.

4

- 4.0** Introduction
- 4.1** Accessing the My Network Settings
- 4.2** Using the My Network Settings

Configuring My Network Settings

Once the FiOS Router is physically connected and the FiOS Router's Main screen is displayed in a web browser, a list of devices connected to the FiOS Router's network appears in the "My Network" column of the screen. From here, basic network settings can be configured.

4 Configuring My Network Settings

4.1 Accessing My Network Settings

4.1 Accessing My Network Settings

To access My Network, click “My Network” (at the top of the center column) in the Main screen.



The “My Network” screen appears:



On the far right side of the screen, in the “Connected Devices” section, is a list of the devices currently connected to the FiOS Router’s network, sorted by connection type and number. The rest of the screen contains the “My Network” section, which displays each device connected to the FiOS Router’s network, and a series of basic configuration settings for each device.

4.2 Using My Network Settings

Various settings can be accessed for a particular device, as follows.

4.2a Access Device

For devices that can be accessed (such as Internet cameras and networked hard drives), locate it in the My Network column, then click **Access Devices** to use the device over the network.

4.2b Access Shared Files

To access the shared files on a particular device, locate the device in the My Network column, then click **Access Shared Files**. A list of shared files appears on the screen.

4.2c Website Blocking

Clicking **Website Blocking** generates the “Parental Control” screen. For more information about using parental controls, see chapter 7, “Using Parental Controls.”



















4 Configuring My Network Settings

4.2 Using My Network Settings

4.2d Block Internet Services

Internet services blocking is used to prevent a device on the network from accessing particular services available on the Internet, such as receiving email or downloading files from FTP sites. To set up Internet services blocking on a networked device:

1. Locate the device in the My Network column, then click **Block Internet Services**. The “Access Control” screen appears.

Access Control					
Block or allow access to Internet services from within the LAN.					
Blocked					
Networked Computer / Device	Network Address	Protocols	Status	Action	
Add					
Allowed					
Networked Computer / Device	Network Address	Protocols	Status	Action	
<input type="checkbox"/> Any	Any	DHCP - UDP 67-69 -> 67	Active	 	
<input type="checkbox"/> Any	Any	DNS - TCP 53 -> 53 TCP 53 -> 53 UDP 53 -> 53 UDP 1024-65535 -> 53	Active	 	
<input type="checkbox"/> Any	Any	IMAP - TCP Any -> 143	Active	 	
<input type="checkbox"/> Any	Any	SMTP - TCP Any -> 25	Active	 	
<input type="checkbox"/> Any	Any	POP3 - TCP Any -> 110	Active	 	
<input type="checkbox"/> Any	Any	HTTPS - TCP Any -> 443	Active	 	
<input type="checkbox"/> Any	Any	HTTP - TCP Any -> 80	Active	 	
<input type="checkbox"/> Any	Any	FTP - TCP Any -> 21	Active	 	
<input type="checkbox"/> Any	Any	Telnet - TCP Any -> 23	Active	 	
Add					

2. Click **Add** in the “Networked Computer/Device” column. The “Add Access Control Rule” screen appears.

Add Access Control Rule	
Networked Computer / Device	Any
Protocol	Any
When should this rule occur?	Always
<input type="button" value="Apply"/> <input type="button" value="Cancel"/>	

3. If this access control rule applies to all networked devices, select “Any” from the “Networked Computer/Device” list box.
4. Select the Internet protocol to be blocked from the “Protocol” drop-down list.

5. If this rule will be active continuously, select **Always** from the “Schedule” drop-down list. If the rule will only be active at certain times, select “User Defined” and click **Add**. Then, add a schedule rule (for more details about schedule rules, see the “Advanced Settings” chapter of this manual).

Note: Make sure the FiOS Router’s date and time settings for your time zone are set correctly for schedule rules to function properly.

6. Click **Apply** to save the changes. The Access Control screen will display a summary of the access control rule.

The user may disable an access control and the service made available without having to remove the service from the Access Control table. This may be useful to make the service available only temporarily, with the expectation that the restriction will be reinstated later.

- To temporarily disable an access control, clear the check box next to the network computer/device.
- To reinstate the restriction at a later time, select the check box next to the network computer/device.
- To remove an access restriction from the Access Control table, click **Remove** for the service. The service will be removed from the Access Control table.

Note: When Web Filtering is enabled, HTTP services cannot be blocked by access control.

4 Configuring My Network Settings

4.2 Using My Network Settings

4.2e Port Forwarding

Activating “Port Forwarding” allows the network to be exposed to the Internet in certain limited and controlled ways, enabling some applications to work from the local network (game, voice, and chat applications, for example), as well as allowing Internet access to servers in the local network. To set this up on a networked device, locate the device in the My Network column, then click **Port Forwarding**. The “Port Forwarding” screen appears.

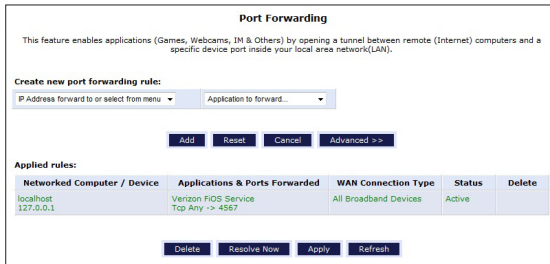

To set up basic port forwarding:

1. Click the arrow next to “IP Address forward or select from menu” to display a menu and either enter the IP address of the item to port forward from, or choose an item from the drop-down menu.
2. Click the arrow next to “Application to forward” and select a pre-configured application from the drop-down menu.
3. The selected application’s forwarded port numbers appear at left, as shown in the figure below.



4. Click **Add**. The new port forwarding rule appears in the “Applied rules” table at the bottom of the screen.
5. Click **Apply** at the bottom of the screen to apply the new rule.

To set up advanced port forwarding:

1. Click the arrow next to “IP Address forward or select from menu” to display a menu and either enter the IP address of the item to port forward from, or choose an item from the drop-down menu.
2. Click the arrow next to “Application to forward” and select a pre-configured application from the drop-down menu.
3. Click **Advanced**. The advanced port forwarding options appear.

Port Forwarding

This feature enables applications (Games, Webcams, IM & Others) by opening a tunnel between remote (Internet) computers and a specific device port inside your local area network(LAN).

Create new port forwarding rule:

IP Address forward to or select from menu	Custom Ports	Advanced Settings
Protocol TCP	Source Ports Any	Destination Ports Any
WAN Connection Type All Broadband Devices	Forward to Port Same as Incoming Port	Schedule Always

Applied rules:

Networked Computer / Device	Applications & Ports Forwarded	WAN Connection Type	Status	Delete
localhost 127.0.0.1	Verizon FiOS Service Tcp Any -> 4567	All Broadband Devices	Active	Delete

4. Select the connection with which this port forwarding rule will be active from the “WAN Connection Type” drop-down list.
5. To select a port to forward communications to (this is optional), select an option from the “Forward to Port” drop-down list. If a single port or range of ports is selected, enter the port numbers in the text boxes that appear.
6. If this port will be active all the time, select “Always” from the “Schedule” drop-down list. If the rule will only be active at certain times, select “User Defined” and click **Add**. Then, add a schedule rule (for more details about schedule rules, see the “Advanced Settings” chapter of this manual).
7. Click **Add** to save the changes. The new port forwarding rule appears in the “Applied rules” table at the bottom of the screen.

4 Configuring My Network Settings

4.2 Using My Network Settings

8. Click **Apply** at the bottom of the screen to apply the new rule.

Note: Some applications, such as FTP, TFTP, PPTP, and H323, require the support of special specific Application Level Gateway (ALG) modules to work inside the local network. Data packets associated with the aforementioned applications contain information that allows them to be routed correctly. An ALG is needed to handle these packets and ensure they reach their intended destinations. The FiOS Router is equipped with a robust list of ALG modules, enabling maximum functionality in the local network. The ALG is automatically assigned based on the destination port.

4.2f View Device Details

To view information about a networked device, or to test a device's connection, locate the device in the My Network column, then click **View Device Details**. The "Device Information" screen appears.

Device Information
This screen provides a detailed breakdown for this device.

Host:	FAELAB23
IP Address:	192.168.1.2
Subnet Mask:	255.255.255.0
MAC Address:	00:11:25:a3:75:b1
Network Connection:	Bridge
Lease Type:	Dynamic
Port Forwarding Services:	None
Windows Shared Folders:	\\192.168.1.2\

To test if this device is connected to your broad band home router, click the Test Connectivity button.

Ping Test:

1. Click **Test Connectivity**. The "Diagnostics" screen appears.

Diagnostics

- Diagnostics can assist in testing network connectivity. This feature pings (ICMP Echo) an IP address and displays the results, such as the number of packets transmitted and received, round trip time, and success status

Ping (ICMP Echo)

Destination:

Number of pings:

Status: **Test Succeeded**

Packets: 4/4 transmitted, 4/4 received, 0% loss

Round Trip Time: Minimum = 0 ms
Maximum = 0 ms
Average = 0 ms

Press the Refresh button to update the status.

2. The FiOS Router automatically runs a ping test, and the results are displayed in the Diagnostics screen.

4.2g Rename This Device

To rename a networked device, locate the device in the My Network column, then click **Rename This Device**. The “Rename Device” screen appears.



The screenshot shows a web form titled "Rename Device". At the top, it says "This Page allows you to change the name of this device, and how it is identified on your network:". Below this, there are three sections: 1. "Current Device Name:" with a text box containing "FAELAB23". 2. "To rename this device, type the new Device Name below and click APPLY" followed by "New Name:" with a text box containing "FAELAB23". 3. "To assign an icon to this device, select from the drop-down box below and click APPLY" followed by "New Icon:" with a drop-down menu showing "Desktop/Laptop" and a small laptop icon. At the bottom are "Apply" and "Back" buttons.

Enter the new name of the device in the “New Name” text box and, if needed, select a new icon for the device from the “New Icon” drop-down list.

5

- 5.0** Introduction
- 5.1** Accessing Network Connections
- 5.2** Network (Home/Office) Connection
- 5.3** Ethernet/Coax Connection
- 5.4** Wireless Access Point Connection
- 5.5** Broadband Ethernet/Coax Connection
- 5.6** WAN PPPoE Connection

Using Network Connections

The FiOS Router supports various local area network (LAN) and wide area network (WAN, or Internet) connections via Ethernet or coaxial cables. The “Network Connections” screens are used to configure the various aspects of the FiOS Router’s network and Internet connections, and create new connections.

5.1 Accessing Network Connections

Caution! The settings covered in this chapter should be configured by experienced network technicians only.

To access the FiOS Router's network connections, in the "My Network" screen, click **Network Connections** from the menu on the left side. The "Network Connections" screen appears.

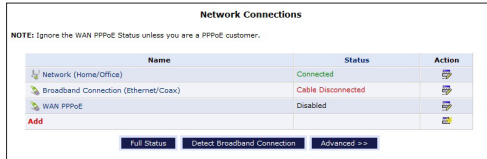

Click **Advanced** to expand the screen and display all connection entries.

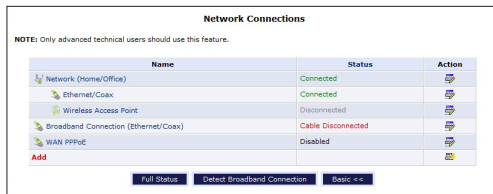

To select a connection, click on its name. The rest of this chapter describes the different network connections available on the FiOS Router, as well as the connection types that can be created.

5.2 Network (Home/Office) Connection

Select **Network (Home/Office)** in the Network Connections screen to generate the “Network (Home/Office) Properties” screen. This screen displays a list of the local network’s properties. The only modifications that can be made from this screen are disabling the connection (by clicking **Disable**) or renaming the connection (by entering a new name in the “Rule Name” text box).

Network (Home/Office) Properties

NOTE: Only advanced technical users should use this feature.

<input type="button" value="Disable"/>	
Name:	<input type="text" value="Network (Home/Office)"/>
Status:	Connected
Network:	Network (Home/Office)
Underlying Device:	Ethernet/Coax Wireless Access Point
Connection Type:	Bridge
MAC Address:	00:26:b8:2f:fd:2e
IP Address:	192.168.1.1
Subnet Mask:	255.255.255.0
IP Address Distribution:	DHCP Server
Received Packets:	17255
Sent Packets:	9570
Time Span:	3:32:41
<input type="button" value="Apply"/> <input type="button" value="Cancel"/> <input type="button" value="Settings"/>	

Note: When a network is disabled, its formerly underlying devices will not be able to get the DHCP address from the network interface to which they were connected.

The Network (Home/Office) connection is used to combine several network devices under one virtual network. For example, a home/office network can be created for Ethernet and other network devices.

5.2a Configuring the Home/Office Network

Click **Settings** in the “Network (Home/Office) Properties” screen to generate a second “Network (Home/Office) Properties” screen.

General

The top part of the screen displays general communication parameters. We recommend not changing the default values in this section unless familiar with networking concepts.

Network (Home/Office) Properties					
NOTE: Only advanced technical users should use this feature.					
General					
Status:	Connected				
When should this rule occur?:	Always				
Network:	Network (Home/Office) ▾				
Connection Type:	Bridge				
Physical Address:	00:26:b8:2f:fa:09				
MTU:	Automatic ▾ 1500				
Internet Protocol	Use the Following IP Address ▾				
IP Address:	192 ▾ 168 ▾ 1 ▾ 1				
Subnet Mask:	255 ▾ 255 ▾ 255 ▾ 0				
Bridge					
	Name	VLANs	Status	STP	Action
	Network (Home/Office)	Disabled	Connected		
<input checked="" type="checkbox"/>	Ethernet/Coax	Disabled	Connected	<input checked="" type="checkbox"/>	
<input type="checkbox"/>	Broadband Connection (Ethernet/Coax)		Cable Disconnected	<input type="checkbox"/>	

Status Displays the connection status of the network.

When should this rule occur? Displays when the rule is active. To schedule rules, see the “Advanced Settings” chapter.

Network Select the type of connection being configured from the drop-down list (options: **Broadband Connection**, **Network [Home/Office]**, or **DMZ**).

Connection Type Displays the type of connection.

Physical Address Displays the physical address of the network card used for the network.

MTU Maximum Transmission Unit (MTU) specifies the largest packet size permitted for Internet transmission. “Automatic” sets the MTU at 1500. Other choices include “Automatic by DHCP,” which sets the MTU according to the DHCP connection, and “Manual,” which allows the MTU to be set manually.

Internet Protocol

This section has three options: **No IP Address**, **Obtain an IP Address Automatically**, and **Use the Following IP Address**.

No IP Address Select this option if the connection will have no IP address. This is useful if the connection operates under a bridge.

Obtain an IP Address Automatically Select this option if the network connection is required by the ISP to obtain an IP address automatically. The server assigning the IP address also assigns a subnet mask address, which can be overridden by entering another subnet mask address.

Use the Following IP Address Select this option if the network connection uses a permanent (static) IP address, then the IP address and subnet mask address.

Bridge

The “Bridge” section of the Configure Network (Home/Office) screen is used to configure the LAN devices connected to the FiOS Router. By default, the Ethernet, Coax, and Wireless Access Point connections are activated. Do not change these settings unless instructed to do so by the ISP.

Status The “Status” column displays the connection status of a particular device.

STP Click in the device’s “STP” check box to enable Spanning Tree Protocol on the device. This protocol provides path redundancy while preventing undesirable loops in the network.

5 Using Network Connections

5.2 Network (Home/Office) Connection

Action The “Action” column contains an icon that, when clicked, generates the configuration screen of the particular device.

End IP Address:	192	.	168	.	1	.	254
Subnet Mask:	255	.	255	.	255	.	0
WINS Server:	0	.	0	.	0	.	0
Lease Time in Minutes:	1440						
<input type="checkbox"/> Provide Host Name If Not Specified by Client							
IP Address Distribution According to DHCP Option 60 (Vendor Class Identifier)							
Vendor Class ID	IP Address		MAC Address	QoS			
Routing Mode:	Route ▾						
Device Metric:	4						
<input type="checkbox"/> Default Route							
Routing Table							
Name	Destination	Gateway	Netmask	Metric	Status	Action	
New Route							
Additional IP Addresses							
	IP Address		Subnet Mask			Action	
New IP Address							

DNS Server

Domain Name System (DNS) is the method by which website or domain names are translated into IP addresses. Specify such an address manually, according to the information provided by the ISP.

To manually configure DNS server addresses, select **Use the Following DNS Server Addresses**. Specify up to two different DNS server addresses, one primary, the other secondary.

IP Address Distribution

The “IP Address Distribution” section of the Configure Network (Home/Office) screen is used to configure the FiOS Router’s Dynamic Host Configuration Protocol (DHCP) server parameters. DHCP automatically assigns IP addresses to network devices. If enabled, make sure to configure the network devices as “DHCP Clients.” There are three options in this section: **Disabled**, **DHCP Server**, and **DHCP Relay**.

Disabled Select this option if statically assigning IP addresses to the network devices.

DHCP Server To set up the network bridge to function as a DHCP server:

1. Select **DHCP Server**.
2. Enter the IP address at which the FiOS Router starts issuing addresses in the “Start IP Address” text boxes. Since the FiOS Router’s default IP address is 192.168.1.1, the Start IP Address should be 192.168.1.2.
3. Enter the end of the IP address range used to automatically issue IP addresses in the “End IP Address” text boxes. The “maximum” IP address that can be entered here is 192.168.1.254.
4. Enter the subnet mask address in the “Subnet Mask” text boxes. The subnet mask determines which portion of a destination LAN IP address is the network portion, and which portion is the host portion.
5. If Windows Internet Naming Service (WINS) is being used, enter the WINS server address in the “WINS Server” text boxes.
6. Enter the amount of time a network device will be allowed to connect to the FiOS Router with its currently issued dynamic IP address in the “Lease Time in Minutes” text box.
7. Click in the “Provide Host Name If Not Specified by Client” check box to have the FiOS Router automatically assign network devices with a host name, in case a host name is not provided by the user.

DHCP Relay Select this option to have the FiOS Router function as a DHCP relay, and enter the IP address in the screen that appears.

5 Using Network Connections

5.2 Network (Home/Office) Connection

Routing

The FiOS Router can be configured to use static or dynamic routing. Dynamic routing automatically adjusts how packets travel on the network, while static routing specifies a fixed routing path to neighboring destinations. To configure routing, enter a device metric in the “Device Metric” text box. The device metric is a value used by the FiOS Router to determine whether one route is superior to another, considering parameters such as bandwidth and delay time.

The screenshot shows the routing configuration interface. It includes fields for End IP Address (192, 168, 1, 254), Subnet Mask (255, 255, 255, 0), WINS Server (0, 0, 0, 0), and Lease Time in Minutes (1440). There is a checkbox for "Provide Host Name If Not Specified by Client". Below this is a section for "IP Address Distribution According to DHCP Option 60 (Vendor Class Identifier)" with a table for Vendor Class ID, IP Address, MAC Address, and QoS. The Routing Mode is set to "Route" and the Device Metric is 4. There is a checkbox for "Default Route". A "Routing Table" section contains a table with columns: Name, Destination, Gateway, Netmask, Metric, Status, and Action. A "New Route" button is visible. Below the routing table is an "Additional IP Addresses" section with a table for IP Address, Subnet Mask, and Action. A "New IP Address" button is visible. At the bottom are "Apply" and "Cancel" buttons.

Routing Table

Clicking **New Route** generates the “New Route” window, where a new route can be configured.

Additional IP Addresses

Clicking **New IP Address** generates the “Additional IP Address Settings” screen, where additional IP addresses can be created to access the FiOS Router via the Network (Home/Office) connection.

5.3 Ethernet/Coax Connection

An Ethernet connection connects computers to the FiOS Router using Ethernet cables, either directly or via network hubs and switches. A Coax connection connects devices (such as set-top boxes) to the FiOS Router using a coaxial cable. Click **Ethernet/Coax** in the Network Connections screen (if needed, click **Advanced** at the bottom of the screen to reveal the “Ethernet/Coax” link below “Network [Home/Office]”) to generate the “Ethernet/Coax Properties” screen. This screen displays a list of the local connection’s properties. The only modifications that can be made from this screen are disabling the connection (by clicking **Disable**) or renaming the connection (by entering a new name in the “Rule Name” text box).

Ethernet/ Coax Properties

NOTE: Only advanced technical users should use this feature.

Name:	EthernetCoax
Status:	Connected
Network:	Network (Home/Office)
Connection Type:	Hardware Ethernet Switch
MAC Address:	00:0f:b3:a7:a9:0a
IP Address Distribution:	Disabled
Received Packets:	705
Sent Packets:	1527
Time Span:	0:05:43
Coax Channel:	Cable Disconnected

Note: If disabling the connection, the FiOS Router must be rebooted for the change to take effect.

5.3a Configuring the Ethernet/Coax Connection

Click **Settings** at the bottom-right of the Ethernet/Coax Properties screen to generate another “Ethernet/Coax Properties” screen.

Ethernet/Coax Properties

NOTE: Only advanced technical users should use this feature.

General

Status: Connected

When should this rule occur?: Always

Network: Network [Home/Office]

Connection Type: Hardware Ethernet Switch

Physical Address: 00:0f:b3:a7:a9:0a

MTU: Automatic 1500

Coax Link

Channel: 1 - 1150MHz

Privacy: Enabled

Password:

CM Ratio: 20

Enable/Disable Coax Link:

Additional IP Addresses

IP Address	Subnet Mask	Action
		<input type="button" value="Add"/>

Coax Connection Stats: [Go to LAN Coax Stats](#)

HW Switch Ports

Port	Status	PVID	VLANs	Action
Port 1	Connected 1000 Mbps Full-Duplex			<input type="button" value="Settings"/>
Port 2	Disconnected			<input type="button" value="Settings"/>
Port 3	Disconnected			<input type="button" value="Settings"/>
Port 4	Disconnected			<input type="button" value="Settings"/>
Port 5	Connected 200 Mbps Full-Duplex			<input type="button" value="Settings"/>

General

The top part of the screen displays general communication parameters. We recommend not changing the default values in this section unless familiar with networking concepts.

Status Displays the connection status of the Ethernet switch.

When should this rule occur? Displays when the rule is active. To schedule rules, see the “Advanced Settings” chapter.

Network Select the type of connection being configured from the drop-down list (**Network [Home/Office]**, **Broadband Connection**, or **DMZ**).

Connection Type Displays the type of connection.

Physical Address Displays the physical address of the network card used for the network.

MTU Maximum Transmission Unit (MTU) specifies the largest packet size permitted for Internet transmission. "Automatic" sets the MTU at 1500. Other choices include "Automatic by DHCP," which sets the MTU according to the DHCP connection, and "Manual," which allows the MTU to be set manually.

Coax Link

Set up the coax link options in this section of the Ethernet/Coax Properties screen. Options include **Channel**, **Privacy**, and **Password**.

Channel Select the Channel from the drop-down list (select from 1-6, or "Automatic").

Privacy Toggle "Privacy" by clicking in the "Enabled" check box. If Privacy is activated, all devices connected via coaxial cable must use the same password. We recommend leaving the Privacy option deactivated.

Password Enter the Coax Link password in this text box.

CM Ratio Select the CM Ratio from the drop-down menu here.

Additional IP Addresses

Clicking **New IP Address** generates the "Additional IP Address Settings" screen, where additional IP addresses can be created to access the FiOS Router via the Ethernet connection.

Coax Connection Status

Click **Go to LAN Coax Stats** to generate the “Coax Connection Status” screen, which gives an overview of all the devices connected to the FiOS Router via coaxial cable.

Coax Connection Stats

NOTE: Only advanced technical users should use this feature, all rates are Mbps.
*next to Router or Device represents the Network Coordinator

Channel: 1 - 1150MHz

Privacy: Disabled

Password:

Connection Speed	Router	Device 1	Device 2	Device 3	Device 4	Device 5	Device 6	Device 7
Device Name	clink0	clink0	clink0	clink0	clink0	clink0	clink0	clink0
MAC Address	00:26:b8:2f:7a:7d	N/A	N/A	N/A	N/A	N/A	N/A	N/A
IP Address	N/A	N/A	N/A	N/A	N/A	N/A	N/A	N/A
Router	N/A	N/A	N/A	N/A	N/A	N/A	N/A	N/A
Device 1	N/A	N/A	N/A	N/A	N/A	N/A	N/A	N/A
Device 2	N/A	N/A	N/A	N/A	N/A	N/A	N/A	N/A
Device 3	N/A	N/A	N/A	N/A	N/A	N/A	N/A	N/A
Device 4	N/A	N/A	N/A	N/A	N/A	N/A	N/A	N/A
Device 5	N/A	N/A	N/A	N/A	N/A	N/A	N/A	N/A
Device 6	N/A	N/A	N/A	N/A	N/A	N/A	N/A	N/A
Device 7	N/A	N/A	N/A	N/A	N/A	N/A	N/A	N/A

Close

HW Switch Ports

This section displays the connection status of the FiOS Router’s four Ethernet ports and single coax port. Clicking on a connection’s “Action” icon (in the column on the right) generates the “Port Settings” screen, where ingress and egress policies can be edited.

Port 1 Settings

VLAN

Ingress Policy: Untagged (Do Not Add VLAN Header) ▾

VLAN ID	Egress Policy	Action
Add		

Apply **Cancel**

5.4 Wireless Access Point Connection

A Wireless Access Point connection connects devices wirelessly. Click **Wireless Access Point** in the Network Connections screen (if needed, click **Advanced** at the bottom of the screen to reveal the “Wireless Access Point” link below “Network [Home/Office]”) to generate the “Wireless Access Point Properties” screen. This screen displays a list of the connection’s properties. The only modifications that can be made from this screen are disabling the connection (by clicking **Disable**) or renaming the connection (by entering a new name in the “Name” text box).

Wireless Access Point Properties

NOTE: Only advanced technical users should use this feature.

Name:	Wireless Access Point
Status:	Disconnected
Network:	Network (Home/Office)
Connection Type:	Wireless 802.11n Access Point
MAC Address:	00:26:b8:2f:7a:80
IP Address Distribution:	Disabled
Received Packets:	0
Sent Packets:	407
Time Span:	0:53:01

Note: If disabling the connection, the FiOS Router must be rebooted for the change to take effect.

5.4a Configure Wireless Access Point

Click **Settings** at the bottom-right of the Wireless Access Point Properties screen generates a second “Wireless Access Point Properties” screen.

Wireless Access Point Properties

NOTE: Only advanced technical users should use this feature.

General			
Status:	Disconnected		
When should this rule occur?:	Always		
Network:	Network (Home/Office) ▾		
Connection Type:	Wireless 802.11n Access Point		
Physical Address:	00:26:b8:2f:7a:80		
MTU:	Automatic ▾	1500	
Additional IP Addresses			
	IP Address	Subnet Mask	Action
New IP Address			+

General

The top part of the screen displays general communication parameters. We recommend not changing the default values in this section unless familiar with networking concepts.

Status Displays the status of the wireless access point connection.

When should this rule occur? Displays when the rule is active. To schedule rules, see the “Advanced Settings” chapter.

Network Select the type of connection being configured from the drop-down list (options: **Network [Home/Office]**, **Broadband Connection**, or **DMZ**).

Connection Type Displays the type of connection.

Physical Address Displays the physical address of the network card used for the network.

MTU Maximum Transmission Unit (MTU) specifies the largest packet size permitted for Internet transmission. “Automatic” sets the MTU at 1500. Other choices include “Automatic by DHCP,” which sets the MTU according to the DHCP connection, and “Manual,” which allows the MTU to be set manually.

Additional IP Addresses

Clicking **New IP Address** generates the “Additional IP Address Settings” screen, where additional IP addresses can be created to access the FiOS Router via the Wireless Access Point connection.

Coax Link

Set up the coax link options in this section of the Configure Coax screen. Options include **Channel**, **Privacy**, and **Password**.

Channel Select the Channel from the drop-down list (select from 1-6, or “Automatic”).

Privacy Toggle “Privacy” by clicking in the “Enabled” check box. If Privacy is activated, all devices connected via coaxial cable must use the same password. We recommend leaving the Privacy option deactivated.

Password Enter the Coax Link password in this text box.

CM Ratio Select the CM Ratio from the drop-down menu here.

Coax Connection Status

Click **Go to LAN Coax Stats** to generate the “Coax Connection Status” screen, which gives an overview of all the devices connected to the FiOS Router via coaxial cable.

Coax Connection Stats								
NOTE: Only advanced technical users should use this feature, all rates are Mbps. * next to Router or Device represents the Network Coordinator								
Channel:		1 - 1150MHz						
Privacy:		Disabled						
Password:								
Connection Speed	Router	Device 1	Device 2	Device 3	Device 4	Device 5	Device 6	Device 7
Device Name	clink0	clink0	clink0	clink0	clink0	clink0	clink0	clink0
MAC Address	00:26:b8:2f:7a:7d	N/A	N/A	N/A	N/A	N/A	N/A	N/A
IP Address	N/A	N/A	N/A	N/A	N/A	N/A	N/A	N/A
Router	N/A	N/A	N/A	N/A	N/A	N/A	N/A	N/A
Device 1	N/A	N/A	N/A	N/A	N/A	N/A	N/A	N/A
Device 2	N/A	N/A	N/A	N/A	N/A	N/A	N/A	N/A
Device 3	N/A	N/A	N/A	N/A	N/A	N/A	N/A	N/A
Device 4	N/A	N/A	N/A	N/A	N/A	N/A	N/A	N/A
Device 5	N/A	N/A	N/A	N/A	N/A	N/A	N/A	N/A
Device 6	N/A	N/A	N/A	N/A	N/A	N/A	N/A	N/A
Device 7	N/A	N/A	N/A	N/A	N/A	N/A	N/A	N/A
Close								

5.5 Broadband Ethernet/Coax Connection

An Ethernet connection connects computers to the FiOS Router using Ethernet cables, either directly or via network hubs and switches. A Coax connection connects devices (such as set-top boxes) to the FiOS Router using a coaxial cable. Click **Broadband Connection (Ethernet/Coax)** in the Network Connections screen to generate the “Broadband Connection (Ethernet/Coax) Properties” screen. This screen displays a list of the connection’s properties. The only modifications that can be made from this screen are disabling the connection (by clicking **Disable**) or renaming the connection (by entering a new name in the “Name” text box).

Broadband Connection (Ethernet/Coax) Properties	
<small>NOTE: Only advanced technical users should use this feature.</small>	
	<input type="button" value="Disable"/>
Name:	Broadband Connection (Ethernet/Coax)
Status:	Cable Disconnected
Network:	Broadband Connection
Connection Type:	Ethernet/Coax
MAC Address:	00:0f:b3:a7:a9:07
IP Address Distribution:	Disabled
Channel:	Cable Disconnected
	<input type="button" value="Apply"/> <input type="button" value="Cancel"/> <input type="button" value="Settings"/>

Note: If disabling the connection, the FiOS Router must be rebooted for the change to take effect.

5.5a Configure Broadband Connection (Ethernet/Coax)

Click **Settings** at the bottom-right of the Broadband Connection (Ethernet/Coax) Properties screen generates a second “Broadband Connection (Ethernet/Coax) Properties” screen.

Broadband Connection (Ethernet/Coax) Properties	
<small>NOTE: Only advanced technical users should use this feature.</small>	
General	
Status:	Cable Disconnected
When should this rule occur?:	Always
Network:	Broadband Connection
Connection Type:	Ethernet/Coax
Physical Address:	00:0f:b3:a7:a9:07
MTU:	Automatic 1500
Coax Link	
Auto Detection:	<input checked="" type="radio"/> On <input type="radio"/> Off
Privacy:	<input checked="" type="checkbox"/> Enabled
Password:	00066647388374886
CM Ratio:	20
WAN Coax Connection Speeds	
Router Tx (Mbps):	0.00
Router Rx (Mbps):	0.00

General

The top part of the screen displays general communication parameters. We recommend not changing the default values in this section unless familiar with networking concepts.

Status Displays the status of the coax connection.

When should this rule occur? Displays when the rule is active. To schedule rules, see the “Advanced Settings” chapter.

Network Select the type of connection being configured from the drop-down list (options: **Network [Home/Office]**, **Broadband Connection**, or **DMZ**).

Connection Type Displays the type of connection.

Physical Address Displays the physical address of the network card used for the network.

MTU Maximum Transmission Unit (MTU) specifies the largest packet size permitted for Internet transmission. “Automatic” sets the MTU at 1500. Other choices include “Automatic by DHCP,” which sets the MTU according to the DHCP connection, and “Manual,” which allows the MTU to be set manually.

Coax Link

Set up the coax link options in this section of the Configure Coax screen. Options include **Channel**, **Privacy**, and **Password**.

Auto Detection Turn on the FiOS Router’s ability to automatically detect a coax connection by clicking in the appropriate radio button.

Channel Select the Channel from the drop-down list (select from 1-6, or “Automatic”).

Privacy Toggle “Privacy” by clicking in the “Enabled” check box. If Privacy is activated, all devices connected via coaxial cable must use the same password. We recommend leaving the Privacy option deactivated.

Password Enter the Coax Link password in this text box.

CM Ratio Select the CM Ratio from the drop-down menu here.

WAN Connection Speeds Displays the Tx and Rx speeds of the connection.

Internet Protocol

This section has three options: **No IP Address**, **Obtain an IP Address Automatically**, and **Use the Following IP Address**.

No IP Address Select this option if the connection will have no IP address. This is useful if the connection operates under a bridge.

Obtain an IP Address Automatically Select this option if the network connection is required by the ISP to obtain an IP address automatically. The server assigning the IP address also assigns a subnet mask address, which can be overridden by entering another subnet mask address.

Use the Following IP Address Select this option if the network connection uses a permanent (static) IP address, then the IP address and subnet mask address.

DHCP Lease

Renew or release the current DHCP lease by clicking on the appropriate button.

DNS Server

The Domain Name System (DNS) is the method by which website or domain names are translated into IP addresses. The connection can be set to automatically obtain a DNS server address, or an address can be set manually, according to information provided by the ISP.

To configure the connection to automatically obtain a DNS server address, select **Obtain DNS Server Address Automatically** from the “DNS Server” drop-down list. To manually configure DNS server addresses, select **Use the Following DNS Server Addresses**. Specify up to two different DNS server addresses, one primary, the other secondary.

Internet Protocol	Obtain an IP Address Automatically ▾
<input type="checkbox"/> Override Subnet Mask:	0 . 0 . 0 . 0
DHCP Lease:	<input type="button" value="Renew"/> <input type="button" value="Release"/>
DNS Server	Obtain DNS Server Address Automatically ▾
IP Address Distribution	Disabled ▾
Routing Mode:	NAPT ▾
Device Metric:	3
<input checked="" type="checkbox"/> Default Route	

IP Address Distribution

The “IP Address Distribution” section of the Configure Broadband Connection (Coax) screen allows the user to configure the FiOS Router’s Dynamic Host Configuration Protocol (DHCP) server parameters. The DHCP automatically assigns IP addresses to network devices. If enabled, make sure to configure the network devices as “DHCP Clients.” There are three options in this section: **Disabled**, **DHCP Server**, and **DHCP Relay**.

Caution! We strongly recommend leaving this setting at “Disabled.”

Disabled Select this option if statically assigning IP addresses to the network devices.

DHCP Server To set up the Broadband Coax connection to function as a DHCP server:

1. Select **DHCP Server**.
2. Enter the IP address at which the FiOS Router starts issuing addresses in the “Start IP Address” text boxes. Since the FiOS Router’s default IP address is 192.168.1.1, the Start IP Address must be 192.168.1.2.
3. Enter the end of the IP address range used to automatically issue IP addresses in the “End IP Address” text boxes. The “maximum” IP address that can be entered here is 192.168.1.254.
4. Enter the subnet mask address in the “Subnet Mask” text boxes. The subnet mask determines which portion of a destination LAN IP address is the network portion, and which portion is the host portion.
5. If a Windows Internet Naming Service (WINS) is being used, enter the WINS server address in the “WINS Server” text boxes.

5 Using Network Connections

5.5 Broadband Ethernet/Coax Connection

6. Enter the amount of time a network device will be allowed to connect to the FiOS Router with its currently issued dynamic IP address in the “Lease Time in Minutes” text box. Just before the time is up, the device’s user will need to make a request to extend the lease or get a new IP address.
7. Click in the “Provide Host Name If Not Specified by Client” check box to have the FiOS Router automatically assign network devices with a host name, in case a host name is not provided by the user.

DHCP Relay Select this option to have the FiOS Router function as a DHCP relay, and enter the IP address in the screen that appears.

Routing

Routing Mode Select one of the following two Routing modes:

- **Route** - Select this option to cause the FiOS Router to act as a router between two networks.
- **NAPT** - Select this option to activate NAPT (Network Address and Port Translation), which refers to network address translation involving the mapping of port numbers and allows multiple machines to share a single IP address. Use NAPT if the local network contains multiple devices, a topology that necessitates port translation in addition to address translation.

Device Metric The device metric is a value used by the FiOS Router to determine whether one route is superior to another, considering parameters such as bandwidth, delay, and more.

Default Route Click in this check box to define the connection as a the default route.

Multicast - IGMP Proxy Default Click in this check box to enable the FiOS Router to issue IGMP (Internet Group Management Protocol) host messages on behalf of hosts the FiOS Router discovers through standard IGMP interfaces. IGMP proxy enables the routing of multicast packets according to the IGMP requests of local network devices asking to join multicast groups.

Routing Table						
Name	Destination	Gateway	Netmask	Metric	Status	Action
New Route						
Internet Connection Firewall						<input checked="" type="checkbox"/> Enabled
<small>(This feature provides the ability to change the default firewall setting on this interface. We highly recommend that you not change the default setting.)</small>						
Additional IP Addresses						
New IP Address		IP Address	Subnet Mask	Action		
Coax Connection Stats:						Go to WAN Coax Stats
<input type="button" value="Apply"/> <input type="button" value="Cancel"/>						

Internet Connection Firewall

Enable or disable the firewall for this interface. It is recommended to keep the firewall enabled for all of the FiOS Router’s connection interfaces.

Additional IP Addresses

Click **New IP Address** to generate the “Additional IP Address Settings” screen, where additional IP addresses can be created to access the FiOS Router via the connection.

Coax Connection Status

Click **Go to WAN Coax Stats** to generate the “WAN Coax Connection Status” screen, which gives an overview of all the devices connected to the FiOS Router via coaxial cable.

WAN Coax Connection Stats			
<small>NOTE: Only advanced technical users should use this feature, all rates are Mbps. * next to Router or Device represents the Network Coordinator</small>			
Channel:	1 - 1000MHz		
Privacy:	Enabled		
Password:	00066947388374966		
Connection Speed			
Device Name	clink1		clink1
MAC Address			
IP Address			
Router	N/A		N/A
	N/A		N/A
<input type="button" value="Close"/>			

5.6 WAN PPPoE Connection

WAN Point-to-Point Protocol over Ethernet (PPPoE) relies on two widely accepted standards: Point-to-Point Protocol and Ethernet. PPPoE enables Ethernet networked computers to exchange information with computers on the Internet. PPPoE supports the protocol layers and authentication widely used in PPP and enables a point-to-point connection to be established in the normally multipoint architecture of Ethernet. A discovery process in PPPoE determines the Ethernet MAC address of the remote device in order to establish a session.

Click **WAN PPPoE** in the Network Connections screen to generate the “WAN PPPoE Properties” screen. This screen displays a list of the connection’s properties. The only modifications that can be made from this screen are disabling the connection (by clicking **Disable**) or renaming the connection (by entering a new name in the “Name” text box).

WAN PPPoE Properties	
NOTE: Only advanced technical users should use this feature.	
<input type="button" value="Enable"/>	
Name:	WAN PPPoE
Status:	Disabled
Network:	Broadband Connection
Underlying Device:	Broadband Connection (Ethernet/Coax)
Connection Type:	PPPoE
Service Name:	
User Name:	verizonfios
<input type="button" value="Apply"/> <input type="button" value="Cancel"/> <input type="button" value="Settings"/>	

5.6a Configuring the WAN PPPoE Connection

Click **Settings** in the WAN PPPoE Properties screen to generate another “WAN PPPoE Properties” screen.

WAN PPPoE Properties

NOTE: Only advanced technical users should use this feature.

General						
Status:	Disabled					
When should this rule occur?:	Always					
Network:	Broadband Connection ▾					
Connection Type:	PPPoE					
MTU:	Automatic ▾ 1492					
Underlying Connection:	Broadband Connection (Ethernet/Coax) ▾					
Service Name (should be filled only if specified by provider):	<input type="text"/>					
<input type="checkbox"/> On Demand (will attempt to connect only when packets are sent)						
Time Between Reconnect Attempts:	30 <input type="text"/> Seconds					
PPP Authentication						
Login User Name (case sensitive):	<input type="text" value="verizonfios"/>					
Login Password:	<input type="password" value="*****"/>					
Retype Password:	<input type="password" value="*****"/>					
<input checked="" type="checkbox"/> Support Unencrypted Password (PAP)						
<input checked="" type="checkbox"/> Support Challenge Handshake Authentication (CHAP)						
<input checked="" type="checkbox"/> Support Microsoft CHAP (MS-CHAP)						
<input checked="" type="checkbox"/> Support Microsoft CHAP Version 2 (MS-CHAP v2)						
PPP Compression						
BSD:	Allow ▾					
Deflate:	Allow ▾					
Internet Protocol	Obtain an IP Address Automatically ▾					
<input type="checkbox"/> Override Subnet Mask:	0 <input type="text"/> . 0 <input type="text"/> . 0 <input type="text"/> . 0 <input type="text"/>					
DNS Server	Obtain DNS Server Address Automatically ▾					
Routing Mode:	NAPT ▾					
Device Metric:	1 <input type="text"/>					
<input checked="" type="checkbox"/> Default Route						
Routing Table						
Name	Destination	Gateway	Netmask	Metric	Status	Action
New Route						
Internet Connection Firewall		<input checked="" type="checkbox"/> Enabled				
<small>(This feature provides the ability to change the default firewall setting on this interface. We highly recommend that you not change the default setting).</small>						
<input type="button" value="Apply"/> <input type="button" value="Cancel"/>						

General

The top part of the screen displays general communication parameters. We recommend not changing the default values in this section unless familiar with networking concepts.

Status Displays the connection status of the WAN PPPoE connection. (“Down,” “Disabled,” “Connected,” etc.)

When should this rule occur? Displays when the rule is active. To schedule rules, see “Advanced Settings” chapter.

Network Select the type of connection being configured from the drop-down list (**Broadband Connection**, **Network (Home/Office)**, or **DMZ**).

Connection Type Displays the type of connection. Since this is PPPoE connection, “PPPoE” is displayed.

MTU MTU (Maximum Transmission Unit) specifies the largest packet size permitted for Internet transmission. “Automatic,” sets the MTU at 1492. Other choices include “Automatic,” which sets the MTU according to the connection to the ISP, and “Manual,” which allows the MTU to be set manually.

Underlying Connection Specify the underlying connection above which the protocol initiates from the drop-down list, which displays all possible underlying devices.

PPP Configuration

Point-to-Point Protocol (PPP) is the most popular method for transporting packets between the user and the ISP.

Service Name Specify the networking peer’s service name, if provided by the ISP, in this text box.

On-Demand To use PPP on demand to initiate the point-to-point protocol session only when packets are actually sent over the Internet, click in this check box. This option should be active on a limited basis

Idle Time Before Hanging Up Enter the amount of idle time, in minutes, before the PPP session automatically ends .

Time Between Reconnect Attempts In this text box, specify the duration between PPP reconnect attempts, as provided by the ISP.

PPP Authentication

Point-to-Point Protocol (PPP) currently supports four authentication protocols: **Password Authentication Protocol (PAP)**, **Challenge Handshake Authentication Protocol (CHAP)**, and **Microsoft CHAP versions 1 and 2**. Select the authentication protocols the FiOS Router may use when negotiating with a PPTP server in this section. Select all the protocols if no information is available about the server's authentication methods. Note that encryption is performed only if Microsoft CHAP, Microsoft CHAP version 2, or both are selected.

Warning: The PPP Authentication settings should not be changed unless instructed to do so by your ISP.

Login User Name Enter the user name (provided by the ISP) in this text box.

Login Password Enter the password (provided by the ISP) in this text box.

Support Unencrypted Password (PAP) Password Authentication Protocol (PAP) is a simple, plain-text authentication scheme. The user name and password are requested by the networking peer in plain-text. PAP, however, is not a secure authentication protocol. Man-in-the-middle attacks can easily determine the remote access client's password. PAP offers no protection against replay attacks, remote client impersonation, or remote server impersonation.

Support Challenge Handshake Authentication (CHAP) Click in this check box to activate CHAP, a challenge-response authentication protocol that uses MD5 to hash the response to a challenge. CHAP protects against replay attacks by using an arbitrary challenge string per authentication attempt.

Support Microsoft CHAP Click in this check box if communicating with a peer that uses Microsoft CHAP authentication protocol.

Support Microsoft CHAP Version 2 Select this check box if communicating with a peer that uses Microsoft CHAP Version 2 authentication protocol.

PPP Compression

The PPP Compression Control Protocol (CCP) is responsible for configuring, enabling, and disabling data compression algorithms on both ends of the point-to-point link. It is also used to signal a failure of the compression/decompression mechanism in a reliable manner.

For each compression algorithm (**BSD** and **Deflate**), select one of the following from the drop-down list:

Reject Selecting this option rejects PPP connections with peers that use the compression algorithm. If Reject is activated, throughput may diminish.

Allow Selecting this option allows PPP connections with peers that use the compression algorithm.

Require Selecting this option insures a connection with a peer using the compression algorithm.

Internet Protocol

Select one of the following Internet Protocol options from the "Internet Protocol" drop-down list:

Obtain an IP Address Automatically This option is selected by default. Change only if required by the ISP. The server that assigns the FiOS Router with an IP address also assigns a subnet mask. Override the dynamically assigned subnet mask by selecting the "Override Subnet Mask" and entering a different subnet mask.

Use the Following IP Address Select this option to configure the FiOS Router to use a permanent (static) IP address. The ISP should provide this address.

DNS Server

The Domain Name System (DNS) is the method by which website or domain names are translated into IP addresses. The FiOS Router can be configured to automatically obtain a DNS server address, or the address can be entered manually, according to the information provided by the ISP.

To configure the connection to automatically obtain a DNS server address, select **Obtain DNS Server Address Automatically** from the “DNS Server” drop-down list. To manually configure DNS server addresses, select **Use the Following DNS Server Addresses** from the “DNS Server” drop-down list. Up to two different DNS server addresses can be entered (Primary and Secondary).

Routing

Routing Mode Select one of the following two Routing modes:

- **Route** - Select this option to cause the FiOS Router to act as a router between two networks.
- **NAPT** - Select this option to activate NAPT (Network Address and Port Translation), which refers to network address translation involving the mapping of port numbers and allows multiple machines to share a single IP address. Use NAPT if the local network contains multiple devices, a topology that necessitates port translation in addition to address translation.

Device Metric The device metric is a value used by the FiOS Router to determine whether one route is superior to another, considering parameters such as bandwidth, delay, and more.

Default Route Click in this check box to define the connection as the default route.

Multicast - IGMP Proxy Default Click in this check box to enable the FiOS Router to issue IGMP (Internet Group Management Protocol) host messages on behalf of hosts the FiOS Router discovers through standard IGMP interfaces. IGMP proxy enables the routing of multicast packets according to the IGMP requests of local network devices asking to join multicast groups.

5 Using Network Connections

5.6 WAN PPPoE Connection

Routing Table

Clicking **New Route** generates the “New Route” screen, where a new route can be configured.

Internet Connection Firewall

Click in the “Enabled” check box to activate the FiOS Router’s firewall on the WAN PPPoE connection.

6

- 6.0** Introduction
- 6.1** Overview
- 6.2** Firewall
- 6.3** Access Control
- 6.4** Port Forwarding
- 6.5** DMZ Host
- 6.6** Port Triggering
- 6.7** Remote Administration
- 6.8** Static NAT
- 6.9** Advanced Filtering
- 6.10** Security Log

Configuring Security Settings

The FiOS Router's security suite includes comprehensive and robust security services: Stateful Packet Inspection, firewall security, user authentication protocols, and password protection mechanisms. These features help protect users' computers from security threats on the Internet.

6.1 Overview

This chapter covers the following security features:

- **Firewall** - select the security level for the firewall.
- **Access Control** - restrict access from the local network to the Internet.
- **Port Forwarding** - enable access from the Internet to specified services provided by computers on the local network.
- **DMZ Host** - configure a network host to receive all traffic arriving at the FiOS Router which does not belong to a known session.
- **Port Triggering** - define port triggering entries to dynamically open the firewall for some protocols or ports.
- **Remote Administration** - enable remote configuration of the FiOS Router from any Internet-accessible computer.
- **Static NAT** - allow multiple static NAT IP addresses to be designated to devices on the network.
- **Advanced Filtering** - control the firewall's settings and rules.
- **Security Log** - view and configure the security log.

6.2 Firewall

The FiOS Router's firewall is the cornerstone of the FiOS Router's security suite. It has been exclusively tailored to the needs of the residential/office user and is pre-configured to provide optimum security.

The firewall provides both the security and flexibility home and office users seek. It provides a managed, professional level of network security while enabling the safe use of interactive applications, such as Internet gaming and video-conferencing.

Additional features, including surfing restrictions and access control, can also be configured locally through the FiOS Router's GUI, or remotely by a service provider.

The firewall also supports advanced filtering, designed to allow comprehensive control over the firewall's behavior. Specific input and output rules can be defined, the order of logically similar sets of rules can be controlled, and distinctions between rules that apply to Internet and local network devices can be made.

The firewall regulates the flow of data between the local network and the Internet. Both incoming and outgoing data are inspected and then either accepted (allowed to pass through the FiOS Router) or rejected (barred from passing through the FiOS Router) according to a flexible and configurable set of rules. These rules are designed to prevent unwanted intrusions from the outside, while allowing local network users access to required Internet services.

The firewall rules specify what types of services available on the Internet can be accessed from the local network and what types of services available in the local network can be accessed from the Internet. Each request for a service the firewall receives, whether originating in the Internet or from a computer in the local network, is checked against the firewall rules to determine whether the request should be allowed to pass through the firewall. If the request is permitted to pass, all subsequent data associated with this request (a "session") will also be allowed to pass, regardless of its direction.

For example, when accessing a website on the Internet, a request is sent out to the Internet for this site. When the request reaches the FiOS Router, the firewall identifies the request type and origin (HTTP and a specific computer in the local network, in this case). Unless the FiOS Router is configured to block requests of this type from this computer, the firewall allows this request to pass out onto the Internet. When the website is returned from the web server, the firewall will associate it with this session and allow it to pass, regardless of whether HTTP access from the Internet to the local network is blocked or permitted.

Note that it is the origin of the request, not subsequent responses to this request, which determines whether a session can be established or not.

6.2a General Screen

The “General” screen is used to configure the FiOS Router’s basic firewall settings.



6 Configuring Security Settings

6.2 Firewall

The FiOS Router features three pre-defined firewall security levels: **Maximum**, **Typical**, and **Minimum**. The table below summarizes the behavior of the FiOS Router for each of the three security levels.

Security Level	Internet requests (incoming traffic)	Local network requests (outgoing traffic)
Maximum Security	Blocked - No access to local network from Internet, except as configured in the Port Forwarding, DMZ host, and Remote Access screens.	Limited - Only commonly used services, such as web browsing and email, are permitted.
Typical Security	Blocked - No access to local network from Internet, except as configured in the Port Forwarding, DMZ host, and Remote Access screens.	Unrestricted - All services are permitted, except as configured in the Access Control screen.
Minimum Security	Unrestricted - Permits full access from Internet to local network; all connection attempts are permitted.	Unrestricted - All services are permitted, except as configured in the Access Control screen.

These services include Telnet, FTP, HTTP, HTTPS, DNS, IMAP, POP3 and SMTP.

Note: Some applications (such as some Internet messengers and peer-to-peer client applications) tend to use these ports if they cannot connect with their own default ports. When applying this behavior, these applications will not be blocked outbound, even at the Maximum Security level.

To configure the FiOS Router's firewall security settings:

1. From the General screen, select a security level by clicking the appropriate radio button. Using the Minimum Security setting may expose the local network to significant security risks, and thus should only be used for short periods of time.
2. Check the "Block IP Fragments" box to protect the local network from a common type of hacker attack that uses fragmented data packets to sabotage the network. Note that VPN over IPSec and some UDP-based services make legitimate use of IP fragments. IP fragments must be allowed to pass into the local network to use these services.
3. Click **Apply** to save changes.

6.3 Access Control

Access control is used to block specific computers within the local network (or even the whole network) from accessing certain services on the Internet. For example, one computer can be prohibited from surfing the Internet, another computer from transferring files using FTP, and the whole network from receiving incoming email.

Access control defines restrictions on the types of requests that can pass from the local network out to the Internet, and thus may block traffic flowing in both directions. In the email example given above, computers in the local network can be prevented from receiving email by blocking their outgoing requests to POP3 servers on the Internet.

Access control also incorporates a list of preset services in the form of applications and common port settings.

6 Configuring Security Settings

6.3 Access Control

6.3a Allow or Restrict Services

To view and allow/restrict these services:

1. Select **Access Control** from the left side of any Security screen. The “Access Control” screen appears.

Note: The “Allowed” section is only visible when the firewall is set to “Maximum.”











Access Control

Block or Allow access to Internet services from within the LAN.

Blocked

Networked Device	IP Address	Protocols	Status	Action
Add				

Allowed

Networked Computer / Device	Network Address	Protocols	Status	Action
<input checked="" type="checkbox"/> Any	Any	UDP 67-68->67	Always	
<input checked="" type="checkbox"/> Any	Any	TCP or UDP 1024-65535->53	Always	
<input checked="" type="checkbox"/> Any	Any	TCP Any->143	Always	
<input checked="" type="checkbox"/> Any	Any	TCP Any->25	Always	
<input checked="" type="checkbox"/> Any	Any	TCP Any->110	Always	
<input checked="" type="checkbox"/> Any	Any	TCP Any->443	Always	
<input checked="" type="checkbox"/> Any	Any	TCP Any->80	Always	
<input checked="" type="checkbox"/> Any	Any	TCP Any->21	Always	
<input checked="" type="checkbox"/> Any	Any	TCP Any->23	Always	
Add				

2. Click **Add**. The “Add Access Control Rule” screen appears.

Note: To block a service, click **Add** in the “Blocked” section of the Access Control screen. To allow outgoing traffic, click **Add** in the “Allowed” section of the screen.

Add Access Control Rule

Networked Computer / Device	<input type="text" value="Any"/>
Protocol	<input type="text" value="Any"/>
When should this rule occur?	<input type="text" value="Always"/>

3. If this access control rule applies to all networked devices, select **Any** from the “Networked Computer/Device” list box. If this rule applies to certain devices only, select **User Defined** and click **Add**. Then, create and add a network object (for more details about adding network objects, see the “Advanced Settings” chapter of this manual).
4. Select the Internet protocol to be allowed or blocked from the “Protocol” drop-down list.
5. If the rule will be active all the time, select **Always** from the “When should this rule occur?” drop-down list. If the rule will only be active at certain times, select **User Defined** and click **Add**. Then, add a schedule rule (for more details about schedule rules, see the “Advanced Settings” chapter of this manual).
6. Click **Apply** to save the changes. The Access Control screen will display a summary of the new access control rule.

Note: To block a service not included in the list, select **User Defined** from the Protocol drop-down menu. The “Edit Service” screen appears. Define the service, then click **OK**. The service will then be automatically added to the top section of the “Add Access Control Rule” screen, and will be selectable.

An access control can be disabled and the service made available without having to remove the service from the Access Control table. This may be useful to make the service available temporarily, with the expectation that the restriction will be reinstated later.

- To temporarily disable an access control, clear the check box next to the service name.
- To reinstate the restriction at a later time, select the check box next to the service name.
- To remove an access restriction from the Access Control table, click **Remove** for the service. The service will be removed from the Access Control table.

6.4 Port Forwarding

Activating “Port Forwarding” allows the network to be exposed to the Internet in certain limited and controlled ways, enabling some applications to work from the local network (game, voice, and chat applications, for example), as well as allowing Internet access to servers in the local network. To set this up on a networked device, locate the device in the My Network column, then click **Port Forwarding**. The “Port Forwarding” screen appears.

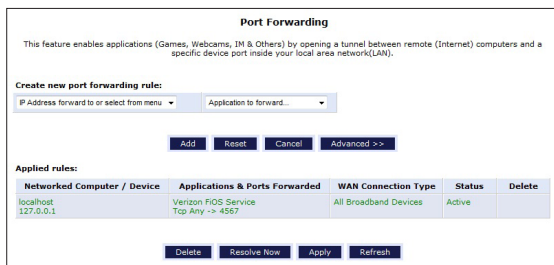

To set up basic port forwarding:

1. Click the arrow next to “IP Address forward or select from menu” to display a menu and either enter the IP address of the item to port forward from, or choose an item from the drop-down menu.
2. Click the arrow next to “Application to forward” and select a pre-configured application from the drop-down menu.
3. The selected application’s forwarded port numbers appear at left, as shown in the figure below.



4. Click **Add**. The new port forwarding rule appears in the “Applied rules” table at the bottom of the screen.
5. Click **Apply** at the bottom of the screen to apply the new rule.

To set up advanced port forwarding:

1. Click the arrow next to “IP Address forward or select from menu” to display a menu and either enter the IP address of the item to port forward from, or choose an item from the drop-down menu.
2. Click the arrow next to “Application to forward” and select a pre-configured application from the drop-down menu.
3. Click **Advanced**. The advanced port forwarding options appear.

Port Forwarding

This feature enables applications (Games, Webcams, IM & Others) by opening a tunnel between remote (Internet) computers and a specific device port inside your local area network(LAN).

Create new port forwarding rule:

IP Address forward to or select from menu ▾	Custom Ports ▾	Advanced Settings
Protocol TCP ▾	Source Ports Any ▾	Destination Ports Any ▾
WAN Connection Type All Broadband Devices ▾	Forward to Port Same as Incoming Port ▾	Schedule Always ▾

Applied rules:

Networked Computer / Device	Applications & Ports Forwarded	WAN Connection Type	Status	Delete
localhost 127.0.0.1	Verizon FiOS Service Tcp Any -> 4567	All Broadband Devices	Active	Delete

4. Select the connection with which this port forwarding rule will be active from the “WAN Connection Type” drop-down list.
5. To select a port to forward communications to (this is optional), select an option from the “Forward to Port” drop-down list. If a single port or range of ports is selected, enter the port numbers in the text boxes that appear.
6. If this port will be active all the time, select “Always” from the “Schedule” drop-down list. If the rule will only be active at certain times, select “User Defined” and click **Add**. Then, add a schedule rule (for more details about schedule rules, see the “Advanced Settings” chapter of this manual).

6 Configuring Security Settings

6.5 DMZ Host

- Click **Add** to save the changes. The new port forwarding rule appears in the “Applied rules” table at the bottom of the screen.
- Click **Apply** at the bottom of the screen to apply the new rule.

Note: Some applications, such as FTP, TFTP, PPTP, and H323, require the support of special specific Application Level Gateway (ALG) modules to work inside the local network. Data packets associated with the aforementioned applications contain information that allows them to be routed correctly. An ALG is needed to handle these packets and ensure they reach their intended destinations. The FiOS Router is equipped with a robust list of ALG modules, enabling maximum functionality in the local network. The ALG is automatically assigned based on the destination port.

6.5 DMZ Host

The DMZ (De-Militarized Zone) host feature allows one device on the network to operate outside the firewall. Designate a DMZ host:

- To use an Internet service, such as an online game or video-conferencing program, not present in the Port Forwarding list and for which no port range information is available.
- To expose one computer to all services without restriction or security.

Warning: A DMZ host is not protected by the firewall and may be vulnerable to attack. Designating a DMZ host may also put other computers in the local network at risk. When designating a DMZ host, consider the security implications and protect it if necessary.

To designate a local computer as a DMZ host:

- Select **DMZ Host** from the left side of any Security screen. The “DMZ Host” screen appears.

DMZ Host

Allow a single networked computer/device to be fully exposed to the Internet.

NOTE: If you have purchased a group of Static IP's and have enabled Static NAT for all of your static IPs, do NOT enable the DMZ Host feature.

DMZ Host IP Address: 192 . 168 . 1 . 0

2. Click in the “DMZ Host IP Address” check box, then enter the IP address of the computer to be designated as a DMZ host. Note that only one network computer can be a DMZ host at any time.
3. Click **Apply**.

Click in the “DMZ Host IP Address” check box again to disable the DMZ host.

6.6 Port Triggering

Port triggering can be described as dynamic port forwarding. By setting port triggering rules, inbound traffic will be allowed to arrive at a specific network host using ports different than those used for outbound traffic. When using port triggering, the outbound traffic triggers the ports at which inbound traffic is directed.

For example, a gaming server is accessed using UDP protocol on port 2222. The gaming server then responds by connecting the user using UDP on port 3333 when a gaming session is initiated. In this case, port triggering must be used, since it conflicts with the following default firewall settings:

- The firewall blocks inbound traffic by default.
- The server replies to the FiOS Router’s IP, and the connection is not sent back to the host, since it is not part of a session.

To resolve the conflict, a port triggering entry must be defined, which allows inbound traffic on UDP port 3333 only after a network host generated traffic to UDP port 2222. This results in the FiOS Router accepting the inbound traffic from the gaming server, and sending it back to the network host which originated the outgoing traffic to UDP port 2222.

6 Configuring Security Settings





6.6 Port Triggering

To configure port triggering:

1. Select **Port Triggering** from the left side of any Security screen. The “Port Triggering” screen appears.

Trigger opening of ports for incoming data.

NOTE: Only advanced technical users should use this feature.

Protocol	Outgoing Trigger Ports	Incoming Ports to Open	Action
<input checked="" type="checkbox"/> L2TP Triggering - Layer Two Tunneling Protocol	UDP Any -> 1701	UDP Any -> Same as Initiating Ports	 
<input checked="" type="checkbox"/> TFTP Triggering - Trivial File Transfer Protocol	UDP 1024-65535 -> 69	UDP Any -> Same as Initiating Ports	 

Add:

2. Select either “User Defined” or “Show All Services” from the drop-down list next to “Add.”
3. If Show All Services is selected in step 2, select a Service from the list. The service is added to the Port Triggering screen as an active protocol.
4. If User Defined is selected in step 2, the “Edit Port Triggering Rule” screen appears. Enter a service name in the appropriate text box, then configure its inbound and outbound trigger ports by clicking the appropriate links.

6.7 Remote Administration

The FiOS Router can be accessed and controlled not only from within the local network, but also from the Internet using remote administration.

To access, select **Remote Administration** from the left side of any Security screen. The “Remote Administration” screen appears.

Warning: Enabling Remote Administration puts the FiOS Router’s network at risk from outside attacks.

Remote Administration

• Configure Remote Administration to the router

 **Attention**

With Remote Administration enabled, your network will be at risk from outside attacks.

Allow Incoming WAN Access to the Telnet Server
<input type="checkbox"/> Using Primary Telnet Port (23)
<input type="checkbox"/> Using Secondary Telnet Port (8023)
<input type="checkbox"/> Using Secure Telnet over SSL Port (992)
Allow Incoming WAN Access to Web-Management
<input type="checkbox"/> Using Primary HTTP Port (80)
<input type="checkbox"/> Using Secondary HTTP Port (8080)
<input type="checkbox"/> Using Primary HTTPS Port (443)
<input type="checkbox"/> Using Secondary HTTPS Port (8443)
Diagnostic Tools
<input checked="" type="checkbox"/> Allow Incoming WAN ICMP Echo Requests (e.g. pings and ICMP traceroute queries)
<input type="checkbox"/> Allow Incoming WAN UDP Traceroute Queries

6.7a Telnet

Telnet is used to create a command-line session and gain access to all system settings and parameters using a text-based terminal. Select the Telnet port to be used by clicking in the appropriate check box, then click **Apply**.

6 Configuring Security Settings

6.8 Static NAT

6.7b Web Management

Web Management is used to obtain access to the FiOS Router's GUI and gain access to all settings and parameters, using a web browser. Both secure (HTTPS) and non-secure (HTTP) access is available. Select the port to be used by clicking in the appropriate text box, then click **Apply**.

Note: Telnet and Web Management remote administration access may be used to modify or disable firewall settings. Local IP addresses and other settings can also be changed, making it difficult or impossible to access the FiOS Router from the local network. Therefore, remote administration access to Telnet or Web Management services should be activated only when absolutely necessary.

6.7c Diagnostic Tools

Diagnostic Tools are used for troubleshooting and remote system management by a user or the ISP.

Note: Encrypted remote administration is performed using a secure SSL connection, and requires an SSL certificate. When accessing the FiOS Router for the first time using encrypted remote administration, a warning appears regarding certificate authentication because the FiOS Router's SSL certificate is self-generated. When encountering this message under these circumstances, ignore it and continue. Even though this message appears, the self-generated certificate is safe and provides a secure SSL connection.

6.8 Static NAT

Static NAT allows devices behind a firewall and configured with private IP addresses appear to have public IP addresses on the Internet. This allows an internal host, such as a web server, to have an unregistered (private) IP address and still be accessible over the Internet. To configure static NAT:

1. Select **Static NAT** from any Security screen. The "Static NAT" screen appears.

Static IP Mapping Table						
ID	Networked Computer / Device	Public IP Address	WAN Connection Type	Status	Port Forwarding	Action
Add						

Apply Cancel Resolve Now Refresh

2. Click **Add**. The “Add NAT/NAPT Rule” screen appears.

Add NAT/NAPT Rule

Local Host: Specify Address | 192.168.1.0

Public IP Address: | | |

WAN Connection Type: All Broadband Devices

Enable Port Forwarding For Static NAT

Apply Cancel

3. Select a source address from the “Specify Address” drop-down list in the “Local Host” row, or enter a IP address in the text box to the right.
4. Enter the public IP address in the “Public IP Address” text boxes.
5. Select the WAN connection type from the “WAN Connection Type” drop-down list.
6. If using port forwarding, activate the “Enable Port Forwarding...” check box, then select a protocol from the “Protocol” drop-down menu.

Repeat these steps to add more static IP addresses from the network.

6 Configuring Security Settings

6.9 Advanced Filtering

6.9 Advanced Filtering

Advanced filtering is designed to allow comprehensive control over the firewall's behavior. Specific input and output rules can be defined, the order of logically similar sets of rules controlled, and distinctions made between rules that apply to the Internet and rules that apply to local network devices.

To access, select **Advanced Filtering** from any Security screen. The "Advanced Filtering" screen appears.

Advanced Filtering

NOTE: Only advanced technical users should use this feature.

Input Rule Sets: Manage all incoming traffic from the Internet

Rule ID	Source Address	Destination Address	Match	Operation	Status	Action
Network (Home/Office) Rules						
						Add
Ethernet/Coax Rules						
						Add
Broadband Connection (Ethernet/Coax) Rules						
						Add
Wireless Access Point Rules						
						Add

Output Rule Sets: Manage all outbound traffic to the Internet

Rule ID	Source Address	Destination Address	Match	Operation	Status	Action
Network (Home/Office) Rules						
						Add
Ethernet/Coax Rules						
						Add
Broadband Connection (Ethernet/Coax) Rules						
						Add
Wireless Access Point Rules						
						Add

Two sets of rules can be configured: input rules and output rules. Following is a description of the set ordering for inbound and outbound packets.

6.9a Inbound/Outbound Packets - Rule Sets

There are numerous rules automatically inserted by the firewall to provide improved security and block harmful attacks. The pre-populated rules displayed are required for operation on the Verizon network.

To configure advanced filtering rules, click **Add** next to the rule title. The “Add Advanced Filter” screen appears.

To add an advanced filtering rule, define the following rule parameters:

6.9c Matching

To apply a firewall rule, a match must be made between IP addresses or ranges and ports. Use the “Source Address” and “Destination Address” drop-down lists to define the coupling of source and destination traffic. Port matching will be defined when selecting a protocol from the “Protocol” drop-down list.. For example, if the FTP protocol is selected, port 21 will be checked for matching traffic flow between the defined source and destination IPs. If applicable, activate the “DSCP,” “Priority,” and “Length” check boxes.

6.9d Operation

This is where the action the rule will take is defined. Select one of the following radio buttons:

- **Drop** - Deny access to packets that match the source and destination IP addresses and VCP reset to the origination peer.
- **Accept** - Allow access to packets that match the source and destination IP addresses and protocol ports defined in upper section of the screen. The data transfer session will be handled using Stateful Packet Inspection (SPI).
- **Accept Connection** - Allow access to connections that match the source and destination IP addresses and protocol ports defined in upper section of the screen.
- **Accept Packet** - Allow access to packets that match the source and destination IP addresses and protocol ports defined in upper section of the screen. The data transfer session will not be handled using Stateful Packet Inspection (SPI), so other packets that match this rule will not be automatically allowed access. This setting is useful when creating rules that allow broadcasting.

6.9e Logging

Click in this check box to add entries relating to this rule to the security log.

6.9f Scheduler (When should this rule occur?)

If advanced filtering needs to be active constantly, select **Always** from the “When should this rule occur?” drop-down list. If the rule will only be active at certain times, select **User Defined** and click **Add**. Then, add a schedule rule (for more details about schedule rules, see the “Advanced Settings” chapter of this manual)

6.10 Security Log

The security log displays a list of firewall-related events, including attempts to establish inbound and outbound connections, attempts to authenticate at an administrative interface (the FiOS Router’s GUI or Telnet terminal), firewall configuration, and system start-up.

To access the security log, select **Security Log** from any Security screen. The “Security Log” screen appears.

Security Log			
<div style="display: flex; justify-content: space-between; align-items: center;"> Close Clear Log Save Log Hazard Settings Refresh </div> <p style="text-align: center; font-size: small;">Press the Refresh button to update the data.</p>			
Time	Event	Event Type	Details
Dec 14 17:26:21 2007	System Log	Message	User authentication success success (Username: admin)
Dec 14 17:26:16 2007	System Log	Message	User authentication failure failure (Invalid password. Username: admin)
Dec 14 16:17:59 2007	System Log	Message	User authentication success success (Username: admin) [repeated 2 times, last time on Dec 14 17:26:16 2007]
Dec 14 16:18:28 2007	Firewall Setup	Configuration change	WBM user Unknown (0.0.0.0) has changed security settings
Dec 14 16:18:05 2007	Firewall Setup	Firewall status changed	enabled
Dec 14 16:18:03 2007	Firewall Setup	Configuration change	WBM user Unknown (0.0.0.0) has changed security settings
Dec 14 16:17:59 2007	System Log	Message	The system is UP!

6.10a Time

The time (based on the FiOS Router’s date and time settings) the event occurred.

6.10b Event

There are three kinds of events listed in the system log: **Firewall Info**, **Firewall Setup**, and **System Log**.

6.10c Event-Type

The “Details” column displays more information about the packet or the event, such as protocol, IP addresses, ports, etc. The following are the available event types that can be recorded in the security log:

- **802.1Q** - a 802.1Q (VLAN) packet has been accepted.
- **Access control** - a packet has been accepted/blocked because of an access control rule.
- **Advanced Filter Rule** - a packet has been accepted/blocked because of an advanced filter rule.
- **ARP** - an ARP packet has been accepted.
- **AUTH:113 request** - an outbound packet for AUTH protocol has been accepted (for maximum security level).
- **Broadcast/Multicast protection** - a packet with a broadcast/multicast source IP has been blocked.
- **Connection closed** - debug message regarding connection.
- **Connection opened** - debug message regarding connection.
- **Default policy** - a packet has been accepted/blocked according to the default policy.
- **Defragmentation failed** - the fragment has been stored in memory and blocked until all fragments have arrived and defragmentation can be performed.
- **DHCP relay agent** - a DHCP relay packet has been received (depends on the distribution)
- **DHCP request** - the FiOS Router sent a DHCP request (depends on the distribution)
- **DHCP response** - the FiOS Router received a DHCP response (depends on the distribution)
- **DMZ network packet** - a packet from a demilitarized zone network has been blocked.

- **Echo/Chargen/Quote/Snork protection** - a packet has been blocked due to Echo/Chargen/Quote/Snork protection.
- **Error: No memory** - a new connection has not been established because of lack of memory.
- **Firewall internal** - from the firewall internal mechanism, in case this event-type is recorded, an accompanying explanation will be added.
- **Firewall rules were changed** - the firewall rule set has been modified.
- **Firewall status changed** - the firewall changed status from up to down or the vice versa, as specified in the event type description.
- **First packet in connection is not a SYN packet** - a packet has been blocked due to a TCP connection that started without a SYN packet.
- **Fragmented packet** - a fragment has been rejected.
- **Fragmented packet, bad align** - a packet has been blocked because, after defragmentation, the packet was badly aligned.
- **Fragmented packet, header too big** - a packet has been blocked because, after defragmentation, the header was too big.
- **Fragmented packet, header too small** - a packet has been blocked because, after defragmentation, the header was too small.
- **Fragmented packet, no memory** - a fragmented packet has been blocked because there is no memory for fragments.
- **Fragmented packet, overlapped** - a packet has been blocked because, after defragmentation, there were overlapping fragments.
- **Fragmented packet, packet exceeds** - a packet has been blocked because, after defragmentation, the packet exceeded.
- **Fragmented packet, packet too big** - a packet has been blocked because, after defragmentation, the packet was too big.
- **FTP port request to 3rd party is forbidden (Possible bounce attack)** - a packet has been blocked.

6 Configuring Security Settings

6.10 Security Log

- **ICMP Flood Protection** - a packet has been blocked, stopping an ICMP (Internet Control Message Protocol) flood.
- **ICMP protection** - a broadcast ICMP message has been blocked.
- **ICMP redirect protection** - an ICMP redirected message has been blocked.
- **ICMP replay** - an ICMP replay message has been blocked.
- **IGMP packet** - an IGMP packet has been accepted.
- **Illegal packet options** - the options field in the packet's header is either illegal or forbidden.
- **IP Version 6** - an IPv6 packet has been accepted.
- **IPv6 over IPv4** - an IPv6 over IPv4 packet has been accepted.
- **Malformed packet: Failed parsing** - a packet has been blocked because it is malformed.
- **Maximum security enabled service** - a packet has been accepted because it belongs to a permitted service in the maximum security level.
- **Multicast IGMP connection** - a multicast packet has been accepted.
- **NAT Error: Connection pool is full. No connection created** - a connection has not been created because the connection pool is full.
- **NAT Error: Conflict Mapping already exists** - a conflict occurred because the NAT mapping already exists, so NAT failed.
- **NAT Error: No free NAT IP** - no free NAT IP, so NAT has failed.
- **NAT out failed** - NAT failed for this packet.
- **Outbound Auth1X** - an outbound Auth1X packet has been accepted.
- **Packet invalid in connection** - an invalid connection packet has been blocked.
- **Parental control** - a packet has been blocked because of parental control.
- **Passive attack on ftp-server: Client attempted to open Server ports** - a packet has been blocked.

- **PPP Discover** - a PPP discover packet has been accepted.
- **PPP Session** - a PPP session packet has been accepted.
- **PPTP connection** - a packet inquiring whether the FiOS Router is ready to receive a PPTP connection has been accepted.
- **Remote administration** - a packet designated for the FiOS Router management has been accepted/blocked.
- **Router initiated traffic** - all traffic the FiOS Router initiates is recorded.
- **Service** - a packet has been accepted because of a certain service, as specified in the event type.
- **Spoofing protection** - a packet from the Internet with a source IP belonging to the local network has been blocked.
- **STP packet** - an STP (Spanning Tree Protocol) packet has been accepted/rejected.
- **SynCookies Protection** - a SynCookies packet has been blocked.
- **Trusted device** - a packet from a trusted device has been accepted.
- **UDP Flood Protection** - a packet has been blocked, stopping a UDP flood.
- **User authentication** - a message arrived during login time, including both successful and failed authentication.
- **Wildcard connection hooked** - debug message regarding connection.
- **Wildcard connection opened** - debug message regarding connection.
- **WinNuke protection** - a WinNuke attack has been blocked.

6 Configuring Security Settings

6.10 Security Log

6.10d Details

Displays a textual description of the event.

6.10e Log Settings

The “Log Settings” screen allows the user to modify the types of events that appear in the FiOS Router’s Security Log. Note that these settings correspond to event logging, not to the events themselves (i.e., disabling an event log removes the event from the Security Log; the event itself will continue to occur).

To view or change the security log settings:

1. Click **Settings** in the Security Log screen. The “Security Log Settings” screen appears.

The screenshot shows the "Log Settings" configuration page. It is organized into several sections, each with a title and a list of events with checkboxes to enable or disable logging for them.

- Accepted Events**
 - Accepted Incoming Connections
 - Accepted Outgoing Connections
- Blocked Events**
 - All Blocked Connection Attempts
 - WinNuke
 - Defragmentation Error
 - Blocked Fragments
 - Syn Flood
 - Echo Chargen
 - Multicast/Broadcast
 - Spoofed Connection
 - Packet Illegal Options
 - UDP Flood
 - ICMP Replay
 - ICMP Redirect
 - ICMP Multicast
 - ICMP Flood
- Other Events**
 - Remote Administration Attempts
 - Connection States
- Log Buffer**
 - Prevent Log Overflow
 - Disable Security Log Aggregation

At the bottom right, there are two buttons: "Apply" and "Cancel".

2. Select the type of activities that will generate a log message:
 - **Accepted Incoming Connections** - activating this check box generates a log message for each successful attempt to establish an inbound connection to the local network.
 - **Accepted Outgoing Connections** - activating this check box generates a log message for each successful attempt to establish an outgoing connection to the public network.

3. Select the type of blocked events to be listed in the log:
 - **All Blocked Connection Attempts** - activating this check box generates log messages for all blocked events.
 - **Other Blocked Events** - if "All Blocked Connection Attempts" is un-checked, select specific blocked events from this list to generate log messages.
4. Click in the "Remote Administration Attempts" check box to write a log message for each remote-administration connection attempt, whether successful or not.
5. Click in the "Connection States" check box to track connection handling by the firewall and Application Level Gateways (ALGs).
6. Click **Apply** to save changes.

7

- 7.0** Introduction
- 7.1** Activating Parental Controls
- 7.2** Rule Summary

Using Parental Controls

The abundance of harmful information on the Internet poses a serious challenge for employers and parents alike: “How can I regulate what my employee or child does on the Internet?” With that question in mind, the FiOS Router’s Parental Controls were designed to allow control of Internet access on all locally networked devices.

7 Using Parental Controls

7.1 Activating Parental Controls

7.1 Activating Parental Controls

To create a basic access policy for a computer on the FiOS Router's network, click Parental Control from the top of the Home screen and follow these instructions:

1. The "Parental Control" screen appears. From the "Networked Computer/Device" list box, select a computer/device, then click **Add**. The computer/device appears in the "Selected Devices" list box.

The screenshot shows the "Parental Control" configuration page. At the top, it says "Parental Control" and provides a brief overview of the feature. Below that, it states "Step 1. Select the Networked Computer/Device for this Allow or Block Rule." There are two list boxes: "Networked Computer/Device" containing "arcas-laptop" and "actonline", and "Selected Devices" which is currently empty. An "Add >>" button is positioned between the two boxes, and a "Remove" button is below the "Selected Devices" box.

2. In the "Limit Access by" section, select one of the following options:
 - **Block the following Websites and Embedded Keywords within a Website** - blocks all websites or keywords (see step 3) from being accessed on the computers/devices selected in step 1.
 - **Allow the following Websites and Embedded Keywords within a Website** - allows access only to the websites or keywords (see step 3) on the computers/devices selected in step 1.
 - **Blocking ALL Internet Access** - blocks all Internet access on the computers/devices selected in step 1.

The screenshot shows the "Limit Access by:" section of the configuration page. It has a heading "Step 2. Create the Parental Control Rules and Schedules." and a "What's This" link. Below are three radio button options: "Block the following Websites and Embedded Keywords within a Website" (which is selected), "Allow the following Websites and Embedded Keywords within a Website", and "Blocking ALL Internet Access".

3. Enter the URL address of a website and, if applicable, the embedded keyword within the website. Click **Add**. The websites and/or keywords selected will appear in the textbox to the right. If you make a mistake, or wish to delete a previously entered website/keyword, select it, then click **Remove**.

The screenshot shows a web configuration interface. On the left, there are two input fields. The first is labeled "Website:" and has an example of "www.example.com". The second is labeled "Embedded keyword within a Website:" and has an example of "sample" within "www.sample.com". To the right of these fields is a large empty text box. A blue button labeled "Add >>" is positioned between the input fields and the text box. A blue button labeled "Remove" is located at the bottom right of the interface.

4. If needed, you can create a schedule for when you want the rule to be active, or inactive. In the "Create Schedule" section, select the affected days.

The screenshot shows the "Create Schedule" section. It includes a link for "What's This" and a "Days:" label. Below the label are seven checkboxes corresponding to the days of the week: Monday, Tuesday, Wednesday, Thursday, Friday, Saturday, and Sunday. All checkboxes are currently unchecked.

5. Select whether the rule will be active or inactive during the schedule you created by clicking the radio button next to the appropriate option.

The screenshot shows the "Times:" section. It contains two radio button options. The first option, "Rule will be active at the scheduled time.", is selected with a filled radio button. The second option, "Rule will be inactive at the scheduled time.", is unselected with an empty radio button.

7 Using Parental Controls

7.2 Rule Summary

- If you want more precise control over the schedule, set up an hourly schedule by entering the start and end times in the appropriate text boxes. Make sure to specify AM or PM.

Start time:	01	:	00	AM/PM
End time:	01	:	00	AM/PM

Note: The hourly schedule only affects the days selected in step 4. For example, if you select Saturday and Sunday, a start time of 10 a.m., and an end time of 3 p.m., the scheduled time will be Saturday/Sunday, 10 a.m. to 3 p.m.

- In the “Create Rule Name” section, enter a rule name and description in the appropriate text boxes.

Create Rule Name:	? What's This
Create your Rule Name and Description	
Rule Name:	<input type="text"/>
Description:	<input type="text"/>

- Click **Apply** to save and apply the new rule.

7.2 Rule Summary

Clicking **Rule Summary** from the menu on the left side generates the “Rule Summary” screen.

Rule Summary					
Rule Name	Description	Computer/Device	View Rule	Edit Rule	Delete Rule
Basic	Basic protection	actiontec			

The Rule Summary screen displays a list of all rules created for the FiOS Router. Additionally, the rule can be viewed by clicking the magnifying glass in the “View Rule” column, or edited by clicking on the icon in the “Edit Rule” column.

8

- 8.0** Introduction
- 8.1** Using Advanced Settings
- 8.2** Utilities
- 8.3** DNS Settings
- 8.4** Network Settings
- 8.5** Configuration Settings
- 8.6** Time Settings
- 8.7** Firmware Upgrade
- 8.8** Routing Settings

Configuring Advanced Settings

The FiOS Router's Advanced Settings cover a wide range of sophisticated configurations available for the Router's firmware and network. Changes to any of the Advanced Settings could adversely affect the operation of the FiOS Router and the local network, and should be made with caution by experienced network technicians only.

8.1 Using Advanced Settings

To access the FiOS Router's Advanced Settings, click **Advanced** at the top of the Home screen. Click **Yes** in the Warning screen, and the "Advanced" screen appears.

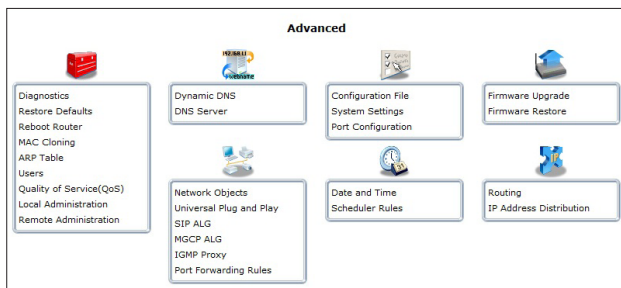

The following settings are explained in this chapter:

- **Diagnostics** - perform diagnostic tests on the FiOS Router
- **Restore Defaults** - reset the FiOS Router to its default settings
- **Reboot Router** - restart the FiOS Router
- **MAC Cloning** - clone MAC addresses
- **ARP Table** - display active devices and their IP and MAC addresses, etc.
- **Users** - create and manage remote users
- **Quality of Service (QoS)** - explained in Appendix A of this manual
- **Local Administration** - allows the user to grant local Telnet access
- **Remote Administration** - explained in chapter 4 of this manual
- **Dynamic DNS** - configure Dynamic DNS settings
- **DNS Server** - manage the local (LAN) network for host name and IP address

8 **Configuring Advanced Settings**

8.1 Using Advanced Settings

- **Network Objects** - configure network object settings
- **Universal Plug and Play** - configure Universal Plug and Play settings
- **SIP ALG** - manage SIP ALG settings
- **MGCP ALG** - manage MGCP ALG settings
- **IGMP Proxy** - manage IGMP Proxy settings
- **Port Forwarding Rules** - manage and create open ports for various Internet protocols or customize an application
- **Configuration File** - manage configuration files
- **System Settings** - modify the FiOS Router's system settings
- **Port Configuration** - configure the FiOS Router's ports
- **Date and Time** - configure the FiOS Router's clock and calendar
- **Scheduler Rules** - schedule firewall activation
- **Firmware Upgrade** - download and install new versions of the FiOS Router's firmware
- **Firmware Restore** - install an older version of the FiOS Router's firmware, or reinstall the current firmware version
- **Routing** - manage routing policies
- **IP Address Distribution** - manage the IP addresses of devices on the network

8.2 Utilities

The first collection of Advanced Settings (beneath the Toolbox icon) are the Utilities settings.

8.2a Diagnostics

The Diagnostics screen can assist in testing network connectivity. This feature pings (ICMP echo) an IP address and displays the results, such as the number of packets transmitted and received, round trip time, and success status. To diagnose network connectivity:

1. Click **Diagnostics** from the Advanced screen. The “Diagnostics” screen appears.

Diagnostics

- Diagnostics can assist in testing network connectivity. This feature pings (ICMP echo) an IP address and displays the results, such as the number of packets transmitted and received, round trip time, and success status

Ping (ICMP Echo)

Destination:	<input type="text" value="192.168.1.2"/>	Go
Number of pings:	<input type="text" value="4"/>	
Status:	Test Failed	
Packets:	4/4 transmitted, 0/4 received, 100% loss	

Press the **Refresh** button to update the status.

Close **Refresh**

2. Enter the IP address or domain name to be tested in the “Destination” field.
3. Click **Go**.
4. In a few seconds, diagnostics statistics will be displayed. If no new information is displayed, click **Refresh**.

8.2b Restore Defaults

If the FiOS Router's factory default settings need to be restored (to build a new network from the beginning, for example), use the following procedure:

1. Click **Restore Defaults** in the Advanced screen. The "Attention" screen appears.
2. If needed, click **Save Configuration File** to save the FiOS Router's current configuration to a file. The FiOS Router's current settings can then be reapplied after restoring default settings (see "Configuration File" in this chapter for more information).

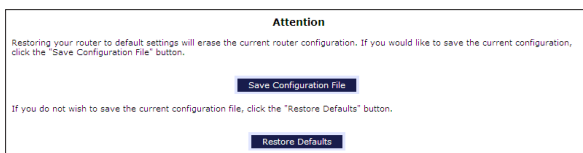

3. Click **Restore Defaults**. The FiOS Router will restart, and factory default settings will be applied

Note: All of the FiOS Router's settings and parameters will be restored to their default values after performing the Restore Default procedure. This includes the administrator password; a user-specified password will no longer be valid.

8.2c Reboot the FiOS Router

To reboot the FiOS Router:

1. Click **Reboot Router** in the Advanced screen. The "Reboot Router" screen appears.



2. Click **OK** to restart the FiOS Router. This may take up to one minute.

To reenter the FiOS Router's GUI after restarting the FiOS Router, click the web browser's "Refresh" button.

8.2d MAC Cloning

A MAC (Media Access Control) address is a hexadecimal code that identifies a device on a network. All networkable devices have a unique MAC address. When replacing another network device with the FiOS Router, the installation process can be simplified by copying the MAC address of the existing computer to the FiOS Router. To do this:

1. Click **MAC Cloning** in the Advanced screen. The “MAC Cloning” screen appears.

MAC Cloning

- MAC Address Cloning provides the ability to emulate the routers MAC address to appear identical to the original hardware address. Use this feature only if your ISP requires MAC Address authentication

Set MAC of Device: Broadband Connection (Ethernet/Coxs)

To Physical Address: 00 13 0f 15 03 17 19 07

[Clone My MAC Address](#)

[Apply](#) [Cancel](#)

2. Enter the MAC address to be cloned in the “To Physical Address” text boxes.
3. Click **Clone My MAC Address** to capture the MAC address of the computer currently accessing the FiOS Router’s GUI. The FiOS Router will now have the new MAC address.

8.2e ARP (Address Resolution Protocol) Table

Clicking **ARP Table** in the Advanced screen generates the “ARP Table” screen. This screen displays the IP and MAC addresses of each DHCP connection.

ARP Table

- The ARP Table displays the IP and MAC addresses of each DHCP connection

ARP Table			
IP Address	MAC Address	Device	DHCP ACL
192.168.1.2	00:11:25:a3:71:03	Network (Home/Office)	Add

[Close](#) [Refresh](#)

8.2f Users

This screen allows you to manage individual users. Additionally, you can enter the maximum number of unsuccessful successive login attempts that can be made before the FiOS Router temporarily disallows all login entries (enter number in the appropriate text box).

To further manage users:

1. Click **Users** in the Advanced screen, which generates the “Users” screen.

Users

- The Users page provides the ability to add or edit Admin or Guest access to the router

Login Configuration

Maximum Unsuccessful Login Attempts:

Full Name	User Name	Permissions	Action
Administrator	admin	Administrator	
New User			

2. Click **New User**, which generates the “User Settings” screen.

User Settings

General

Full Name:

User Name (case sensitive):

New Password:

Retype New Password:

Permissions:

E-Mail Notification

[Click here to configure notification Mail Server](#)

Notification Address:

System Notify Level:

Security Notify Level:

3. Specify the following parameters in the "General" section of the screen:
 - **Full Name** - The user's full name.
 - **User Name** - The name a remote user will use to access the home or office network. This entry is case-sensitive.
 - **New Password/Retype New Password** - The password for the user (enter again to confirm).
 - **Permissions** - The level of access the user is allowed. Options include **Administrator** or **Limited**.
4. **E-mail Notification** - Email notification can be used to receive indications of system events for a predefined severity classification. The available types of events are "System" or "Security" events. The available severity of events are **Error**, **Warning**, and **Information**. To configure email notification for a specific user:
5. Make sure an outgoing mail server has been configured in "System Settings". If not, click **Click Here to Configure Notification Mail Server** to configure the outgoing mail server.
6. Enter the user's email address in the "Notification Address" text box.
7. Select the "System" and "Security" notification levels in the "System Notify Level" and "Security Notify Level" drop-down lists.

Note: Changing any of the user parameters will prompt the connection associated with the user to terminate. For changes to take effect, activate the connection manually after modifying user parameters.

8.2g Quality of Service

The FiOS Router's QoS (Quality of Service) capabilities are covered in detail in appendix A of this manual.

8.2h Local Administration

Clicking **Local Administration** in the Advanced screen generates the “Local Administration” screen. This screen allows the user to grant local Telnet access using a particular Telnet port.

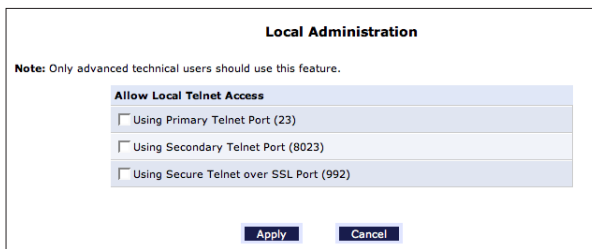

The screenshot shows a web interface titled "Local Administration". Below the title is a note: "Note: Only advanced technical users should use this feature." Underneath the note is a section titled "Allow Local Telnet Access" which contains three rows, each with a checkbox and a label: "Using Primary Telnet Port (23)", "Using Secondary Telnet Port (8023)", and "Using Secure Telnet over SSL Port (992)". At the bottom of the form are two buttons: "Apply" and "Cancel".

To use, select a Telnet port by clicking in the appropriate check box, then click **Apply**.

8.2i Remote Administration

The FiOS Router’s Remote Administration capabilities are covered in detail in the chapter 6 of this manual.

8.3 DNS Settings

The second section of the Advanced window is the DNS (Domain Name System) settings section, which includes “Dynamic DNS” and “DNS Server.”

8.3a Dynamic DNS

Dynamic DNS creates a dynamic IP address that is aliased to a static hostname, allowing a computer on the network to be more easily accessible from the Internet. Typically, when connecting to the Internet, the service provider assigns an unused IP address from a pool of IP addresses, and this address is used only for the duration of a specific connection. Dynamically assigning addresses extends the usable pool of available IP addresses, while maintaining a constant domain name. This allows the user to access a device (a camera, for example) from a remote location, since the device will always have the same IP address.

When using Dynamic DNS, each time the IP address provided by the ISP changes, the DNS database changes accordingly to reflect the change. In this way, even though the IP address of the computer changes often, its domain name remains constant and accessible.

Setting up Dynamic DNS

To set up Dynamic DNS on the FiOS Router, click **Dynamic DNS** in the Advanced screen. When the “Dynamic DNS” screen appears, click **New Dynamic DNS Entry**.

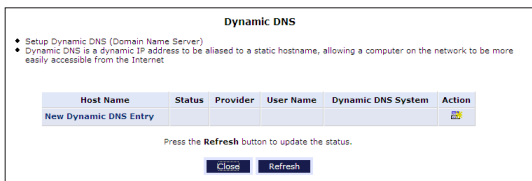

8 Configuring Advanced Settings

8.3 DNS Settings

Another Dynamic DNS screen appears.

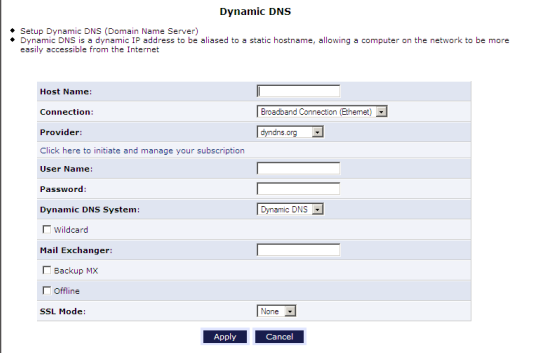

The screenshot shows a web form titled "Dynamic DNS" with the following fields and options:

- Host Name:** A text input field.
- Connection:** A dropdown menu with "Broadband Connection (Ethernet)" selected.
- Provider:** A dropdown menu with "dyndns.org" selected.
- User Name:** A text input field.
- Password:** A text input field.
- Dynamic DNS System:** A dropdown menu with "Dynamic DNS" selected.
- Wildcard
- Mail Exchanger:** A text input field.
- Backup MX
- Offline
- SSL Mode:** A dropdown menu with "None" selected.

At the bottom of the form are "Apply" and "Cancel" buttons.

Configure the following parameters:

Host Name

Enter the full Dynamic DNS domain in this text box.

Connection

Select the connection with which to couple the Dynamic DNS service. Options include **Broadband Connection (Ethernet)**, **Broadband Connection (Coax)**, and **WAN PPPoE**.

Provider

Select the FiOS Router's Dynamic DNS account provider from the drop-down list.

User Name

Enter the Dynamic DNS user name in this text box.

Password

Enter the Dynamic DNS password in this text box.

Dynamic DNS System

Select one of the options from the drop-down list.

Wildcard

Select the "Wildcard" check box to allow any URL that includes the domain name ("here.yourhost.dyndns.org," for example) to connect.

Mail Exchanger

Enter the mail exchange server address. This will redirect all emails arriving at the Dynamic DNS address to the mail server.

Backup MX

Select this check box to designate the mail exchange server to be a backup server.

Offline

Disable the Dynamic DNS feature by clicking this check box. This feature is available only to users who have purchased some type of upgrade credit from the Dynamic DNS provider. Note that changing the redirection URL can only be performed via the Dynamic DNS provider's website.

8 Configuring Advanced Settings

8.3 DNS Settings

SSL Mode

If the Dynamic DNS service chosen supports SSL, select the SSL mode from the drop-down menu (options: **None**, **Chain**, **Direct**).

To edit the host name or IP address of an entry:

1. Click the appropriate “Edit” icon in the Action column. The “DNS Entry” screen appears.

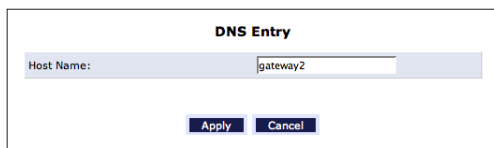

The screenshot shows a dialog box titled "DNS Entry". Inside the dialog, there is a label "Host Name:" followed by a text input field containing the text "gateway2". Below the input field, there are two buttons: "Apply" and "Cancel".

2. If the host was manually added to the DNS Table, its host name and/or IP address can be modified. Otherwise, only modify its host name.
3. Click **Apply** to save the changes.

To remove a host from the DNS table, click the appropriate “Delete” icon in the Action column. The entry will be removed from the table.

8.3b DNS Server

The Domain Name System (DNS) translates domain names into IP addresses, and vice versa. The FiOS Router’s DNS server is an auto-learning DNS, which means that when a new computer is connected to the network, the DNS server learns its name and automatically adds it to the DNS table. Other network users can immediately communicate with this computer using either its name or its IP address.

The FiOS Router’s DNS also provides the following services:

- shares a common database of domain names and IP addresses with the DHCP server;
- supports multiple subnets within the local network simultaneously;
- automatically appends a domain name to unqualified names;

- allows new domain names to be added to the database using the FiOS Router’s GUI;
- permits a computer to have multiple host names;
- and permits a host name to have multiple IPs (needed if a host has multiple network cards).

The DNS server does not require configuration. However, the list of computers known by the DNS can be viewed or a new computer can be added to the list.

DNS Table

To view the list of computers stored in the DNS table, click **DNS Server** in the Advanced screen. The “DNS Server” screen appears.

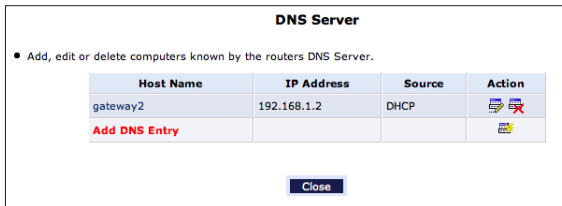

To add a new entry to the list:

1. Click **Add DNS Entry** in the DNS Server screen. The “DNS Entry” screen appears.

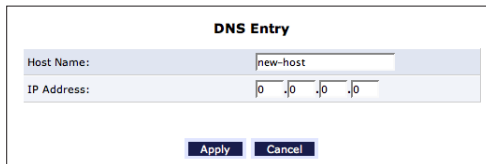

2. Enter the computer’s host name in the “Host Name” text box.
3. Enter the computer’s IP address in the “IP Address” text boxes.
4. Click **Apply** to save the changes.

8.4 Network Settings

The Network Settings section of the Advanced screen includes settings that affect the FiOS Router's network.

8.4a Network Objects

Network objects is used to define a part of the FiOS Router's network (a group of computers, for example) by MAC addresses, IP addresses, and/or host names. The defined part becomes a "network object," and settings, such as configuring system rules, can be applied to all devices defined as part of the network object at once. For example, instead of setting the same website filtering configuration to five computers one at a time, the computers can be defined as a network object, and website filtering configuration can then be applied to all the computers simultaneously.

Network objects can be used to apply security rules based on host names instead of IP addresses. This may be useful, since IP addresses change from time to time. Moreover, it is possible to define network objects according to MAC addresses, making rule application more persistent against network configuration settings. To define a network object:

1. Click **Network Objects** in the Advanced screen. The "Network Objects" screen appears.

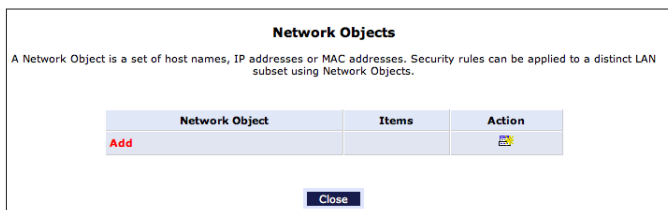

2. Click **Add**. The “Edit Network Object” screen appears.

Edit Network Object

Network Object

Description:

Items

Item	Action
Add	

3. Specify a name for the network object in the “Description” text box.
4. Click **Add**. The “Edit Item” screen appears.

Edit Item

Network Object Type:

IP Address:

5. Select the type of network object type from the “Network Object Type” list box. Options include **IP address**, **IP Subnet**, **IP Range**, **MAC Address**, **Host Name**, and **DHCP Option**.
6. Repeat to create other network objects, if needed. When finished, click **Apply** to save all created network objects.

8.4b Universal Plug and Play (UPnP)

To access the UPnP settings, perform the following:

1. Click **Universal Plug and Play** in the Advanced screen. The “Universal Plug and Play” settings screen appears.

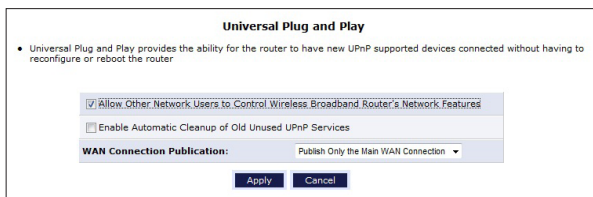

2. Click in the “Allow Other Network Users to Control Wireless Broadband FiOS Router’s Network Features” check box to enable UPnP and allow UPnP services to be defined on any of the network hosts.
3. Click in the “Enable Automatic Cleanup of Old Unused UPnP Services” check box to enable automatic cleanup of invalid rules. When enabled, this feature checks validity of all the UPnP services and rules every five minutes. Any old and unused UPnP defined service is removed, unless a user defined rule depends on it. Since there is a maximum limitation on the number of UPnP defined services (256), enable the cleanup feature if the limit is in danger of being exceeded.
4. If applicable, in the “WAN Connection Publication” drop-down list, select one of the publishing options (**Publish Only the Main WAN Connection** or **Publish All WAN Connections**)

UPnP services are not deleted when disconnecting a computer without proper shutdown of the UPnP application (e.g., messenger). Thus, services may often not be deleted. This will eventually lead to exhaustion of rules and services, and no new services can be defined. In this scenario, the cleanup feature will find the invalid services and remove them, preventing services exhaustion.

8.4c SIP ALG

This screen allows the user to enable/disable SIP ALG. It is disabled by default. Do not enable this option unless instructed to do so by the ISP.

SIP ALG

Please note that Only advanced users should use this option to enable or disable SIP ALG.

Enable Disable

8.4d MGCP ALG

This screen allows the user to enable/disable MGCP ALG. It is disabled by default. Do not enable this option unless instructed to do so by the ISP.

MGCP ALG

Please note that Only advanced users should use this option to enable or disable MGCP ALG.

Enable Disable

8 Configuring Advanced Settings

8.4 Network Settings

8.4e IGMP Proxy

This screen allows the user to configure various IGMP proxy settings.

IGMP Proxy	
IGMP Proxy (Enable/Disable):	Disabled
Querier Configuration	
IGMP Version:	IGMPv3
Fast Leave:	Enabled
Robustness (>= 1):	2
Query Interval (>= 1 second):	125
Query Response Interval (>= 1 second):	10
Client (Host) Configuration	
Unsolicited Report Interval (1 to 25 seconds):	1
Persistent Join Interval (1 to 25 seconds):	1
Apply Cancel	

IGMP Proxy (Enable/Disable)

Activate or deactivate IGMP Proxy by clicking on the down arrow and selecting **Enabled** or **Disabled**.

IGMP Version

Select the IGMP Proxy version by clicking on the down arrow and selecting **IGMPv1**, **IGMPv2**, or **IGMPv3**.

Fast Leave

Activate or deactivate Fast Leave by clicking on the down arrow and selecting **Enabled** or **Disabled**.

Robustness

Select the level of robustness by entering a number greater than or equal to 1.

IGMP Proxy (Enable/Disable)

Activate or deactivate IGMP Proxy by clicking on the down arrow and selecting **Enable** or **Disabled**.

Query Interval

Set the query interval here. The entered time period (in seconds) must be greater than or equal to 1.

Query Response Interval

Set the query response interval here. The entered time period (in seconds) must be greater than or equal to 1.

Unsolicited Report Interval

Set the unsolicited report interval here. The entered time period (in seconds) must be between 1 and 25.

Persistent Join Interval

Set the persistent join interval here. The entered time period (in seconds) must be between 1 and 25.

Interface Multicast Filtering

Clicking **Interface Multicast Filtering** from the menu on the left side of any IGMP Proxy screen generates the Interface Multicast Filtering screen. Set the Interface Multicast Filtering options for each listed interface (Ethernet, Coax, and Wireless Access Point). When finished, click **Apply**.

Interface Multicast Filtering	
Interface Description	IGMP Allowed
Ethernet/Coax	<input checked="" type="checkbox"/>
Wireless Access Point	<input checked="" type="checkbox"/>

8 Configuring Advanced Settings

8.4 Network Settings



Host Multicast Filtering

Clicking **Host Multicast Filtering** from the menu on the left side of any IGMP Proxy screen generates the Host Multicast Filtering screen. Set the Host Multicast Filtering options here. Clicking on the Action icon generates another screen in which the host entry options can be entered. When finished, click **Apply**.

Host Multicast Filtering				
Host IP Address	STB	IGMP Allowed	Max Channel Allowed	Action
192.168.1.2	X	X	0	
<input type="button" value="Apply"/> <input type="button" value="Cancel"/>				

ACL Multicast Filtering

Clicking **ACL Multicast Filtering** from the menu on the left side of any IGMP Proxy screen generates the ACL Multicast Filtering screen. Set the ACL Multicast Filtering options in this screen, including activating whitelists and/or blacklists. Clicking **Add** generates a new screen in which additional addresses can be added to the list(s). When finished, click **Apply**.

ACL Multicast Filtering		
<input type="checkbox"/> Whitelist Enabled		
<input type="checkbox"/> Blacklist Enabled		
WhiteList Access Control List		
Multicast Address	Subnet Mask	Action
Add		
BlackList Access Control List		
Multicast Address	Subnet Mask	Action
Add		
<input type="button" value="Apply"/> <input type="button" value="Cancel"/>		

Service Multicast Filtering

Clicking **Service Multicast Filtering** from the menu on the left side of any IGMP Proxy screen generates the Service Multicast Filtering screen. When finished, click **Apply**.

Service Multicast Filtering				
Service	Multicast Address Range	Max STBs Allowed	Max Non-STBs Allowed	Action
Add				

Clicking **Add** generates the Multicast Service screen, in which additional services can be added, maximum STBs and non-STBs can be delineated, and new multicast address can be created (by clicking **Add**). When finished, click **Apply**.

Multicast Service	
Service:	<input type="text"/>
Max STBs Allowed:	<input type="text"/>
Max Non-STBs Allowed:	<input type="text"/>
Multicast Address Range	
Multicast Address	Subnet Mask
Add	

8 Configuring Advanced Settings

8.4 Network Settings

8.4f Port Forwarding Rules

Port forwarding rules include a list of preset and user-defined applications and common port settings. These rules can be used in various security features, such as Access Control and Port Forwarding. New rules can be added to support new applications or existing ones can be edited when needed. Additionally, clicking **Advanced** on the bottom of the “Port Forwarding Rules” screen reveals a list of preconfigured protocols that can be activated with a single click. To define a port forwarding rule:

1. Click **Port Forwarding Rules** in the Advanced screen. The “Port Forwarding Rules” screen appears.

Port Forwarding Rules

Below is a list of currently configured Protocols that are implemented in the Wireless Broadband Router.

Protocols	Ports	Action
Active Worlds	TCP Any → 3000 Any → 3619 Any → 7777 Any → 7000-7100 Any → 443 UDP Any → 7777 Any → 5570 Any → 443	  
Age of Empires I	TCP Any → 2300-2400 Any → 47824 UDP Any → 2300-2400 Any → 6073	  
Age of Empires II - Age of Kings	TCP Any → 47824 Any → 2300-2400 Any → 100 - UDP Any → 6073 Any → 2300 Any → 4800 Any → 100	  
Age of Empires III	TCP Any → 2300 Any → 90 UDP Any → 2300-2310	  
Age of Wonders	TCP Any → 2300-2400 Any → 47824 UDP Any → 2300-2400 Any → 47824	  
AIM Talk	TCP Any → 5190	  
AIM Talk (Port Triggering)	TCP Any → 4099	  
Aliens vs. Predator	UDP Any → 80 Any → 2300-2400 Any → 8000-8900	  
America Online (AOL)	TCP Any → 5190-5193 UDP Any → 5193	  

2. Click **Add** at the bottom of the screen. The “Edit Service” screen appears.

Edit Service

Service Name:

Service Description:

Server Ports

Protocol	Server Ports	Action
Add Server Ports		

3. Name the service in the "Service Name" text box and, if needed, enter a description of the service in the "Service Description" text box, then click **Add Service Ports**. The "Edit Service Server Ports" screen appears.

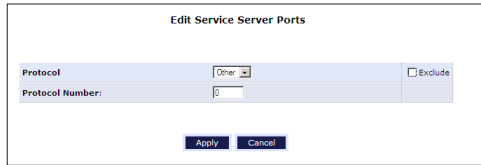

The screenshot shows a web interface titled "Edit Service Server Ports". It features a light blue header bar with the title. Below the header, there are two rows of input fields. The first row is labeled "Protocol" and contains a drop-down menu with "Other" selected, and a checkbox labeled "Exclude". The second row is labeled "Protocol Number:" and contains a text input field with the number "0" entered. At the bottom of the form, there are two buttons: "Apply" and "Cancel".

4. Select a protocol from the "Protocol" drop-down list. To create a new protocol, select "Other." After selecting a protocol, the screen will refresh, displaying the relevant text boxes needed to edit the particular protocol.
5. Click **Apply** to save the changes.

8.5 Configuration Settings

This section includes settings that affect the FiOS Router's configuration.

8.5a Configuration File

Use the FiOS Router's Configuration File feature to view, save, and load configuration files, which are used to backup and restore the FiOS Router's current configuration. To do this:

1. Click **Configuration File** in the Advanced screen. The "Configuration File" screen appears.

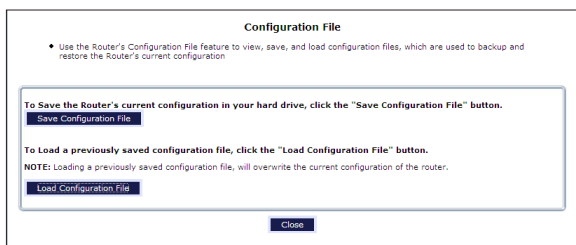

2. Click **Load Configuration File** to load the previous configuration from a file and restart the FiOS Router. Only configuration files saved on a particular FiOS Router can be applied to the FiOS Router; configuration files cannot be transferred between FiOS Routers.
3. Click **Save Configuration File** to backup the current configuration to a file.

WARNING! Manually editing a configuration file can cause the FiOS Router to malfunction or become completely inoperable.

8.5b System Settings

Clicking **System Settings** in the Advanced screen generates the “System Settings” screen, where various system and management parameters can be configured.

System Settings

Router Status

Wireless Broadband Router's Hostname:

Local Domain:

Wireless Broadband Router

Automatic Refresh of System Monitoring Web Pages

Prompt for Password When Accessing via LAN

Warn User Before Configuration Changes

Session Lifetime: Seconds

Configure number of concurrent users that can be logged into the router:

Remote Administration

Management Application Ports

Primary HTTP Management Port:

Secondary HTTP Management Port:

Primary HTTPS Management Port:

Secondary HTTPS Management Port:

Primary Telnet Port:

Secondary Telnet Port:

Secure Telnet over SSL Port:

Management Application SSL Authentication Options

Primary HTTPS Management Client Authentication:

Secondary HTTPS Management Client Authentication:

Secure Telnet over SSL Client Authentication:

System Logging

Enable Logging

Low Capacity Notification Enabled

Allowed Capacity Before Email Notification: %

System Log Buffer Size: KB

Remote System Notify Level:

Security Logging

Low Capacity Notification Enabled

Allowed Capacity Before Email Notification: %

Security Log Buffer Size: KB

Remote Security Notify Level:

Outgoing Mail Server

Server:

From Email Address:

Port:

Server Requires Authentication

Auto WAN Detection

Enabled

PPP Timeout: Seconds

DHCP Timeout: Seconds

Number of Cycles:

Auto Detection Continuous Trying

8 Configuring Advanced Settings

8.5 Configuration Settings

System

Use the “System” section of this screen to configure the following two options:

Wireless Broadband Router’s Hostname - Specify the FiOS Router’s host name by entering it into the this text box. The host name is also the FiOS Router’s URL address, so it can be entered here, rather than entering 192.168.1.1.

Local Domain - Specify the network’s local domain by entering it into this text box.

Wireless Broadband Router

Use this section to configure the following:

Automatic Refresh of System Monitoring Web Page - Click in this check box to activate the automatic refresh of system monitoring web pages.

Prompt for Password When Accessing via LAN - Click in this check box to cause the FiOS Router to ask for a password when trying to connect to the network.

Warn User Before Network Configuration Changes - Click in this check box to activate user warnings before network configuration changes take effect.

Session Lifetime - After the FiOS Router has been inactive for a period of time, the user must reenter a user name and password to continue accessing the GUI. To change the length of this time period, enter the amount of time (in seconds) in the “Session Lifetime” text box.

Configure a number of concurrent users... - Used to limit the number of users that can access the FiOS Router at the same time. Select the number of users from the drop-down list.

Management Application Ports

This section allows the following management application ports to have their default port numbers to be changed:

- primary/secondary HTTP ports
- primary/secondary HTTPS ports

- primary/secondary Telnet ports
- secure Telnet over SSL ports

Management Application SSL Authentication Options

This section allows the user to access the FiOS Router's GUI through a browser or Telnet as a secure socket layer (SSL) session.

System Logging

Use this section to configure the following system log options.

Enable Logging - Click in this check box to activate system logging.

Low Capacity Notification Enabled - Click in this check box to activate low capacity notification (works in tandem with "Allowed Capacity Before Email Notification" and "System Log Buffer Size" options).

Allowed Capacity Before Email Notification - Enter the percentage of system log buffer capacity reached to trigger an email notification.

System Log Buffer Size - Enter the size of the system log buffer in this text box.

Remote System Notify Level - This feature is used to specify the type of information received for remote system logging. Options include **None**, **Error**, **Warning**, and **Information**.

8 **Configuring Advanced Settings**

8.5 Configuration Settings

Security Logging

Use this section to configure the following security log options.

Low Capacity Notification Enabled - Click in this check box to activate low capacity notification (works in tandem with “Allowed Capacity Before Email Notification” and “Security Log Buffer Size” options).

Allowed Capacity Before Email Notification - Enter the percentage of security log buffer capacity reached to trigger an email notification.

Security Log Buffer Size - Enter the size of the security log buffer in this text box.

Remote Security Notify Level - This feature is used to specify the type of information received for security logging. Options include **None**, **Error**, **Warning**, and **Information**.

Outgoing Mail Server

Use this section to configure the outgoing mail server options. This server is used to format and send system and security log email notifications.

Server - Enter the host name of the outgoing (SMTP) server in this text box.

From Email Address - Email notifications require a “from” address. Enter a “from” email address in this text box.

Port - Enter the port number of the email server in this text box.

Server Requires Authentication - If the email server requires authentication, click in this check box, then enter a user name and password in the “User Name” and “Password” text boxes that appear.

Auto WAN Detection

When activated, Auto WAN Detection causes the FiOS Router to automatically search for a WAN connection.

Enable Logging - Clicking in this check box activates automatic WAN detection.

PPP Timeout - Enter the amount of time (in seconds) before the FiOS Router stops attempting to establish a broadband PPP connection.

DHCP Timeout - Enter the amount of time (in seconds) before the FiOS Router stops attempting to establish a broadband DHCP connection.

Number of Cycles - Enter the number of times the FiOS Router attempts to detect a broadband PPP and DHCP connection.

Auto Detection Continuous Trying - Click in this check box to cause the FiOS Router to indefinitely search for a broadband connection.

8.5c Ethernet Port Configuration

Ethernet port configuration allows the user to set up the FiOS Router’s Ethernet ports as either full- or half-duplex ports, at either 10 Mbps or 100 Mbps. Selecting the “Auto” option causes the port to emulate the speed and duplex configuration of the port with which it is communicating.

Ethernet Port Configuration			
Port	Speed & Duplex		Status
WAN Port	Auto	▼	Disconnected
LAN Port 1	100 Full-Duplex		Connected
LAN Port 2	Auto	▼	Disconnected
LAN Port 3	Auto	▼	Disconnected
LAN Port 4	Auto	▼	Disconnected

8.6 Time Settings

The Time settings section of the Advanced window features utilities that involve times, dates and schedules.

8.6a Date and Time

To configure date, time, and daylight saving settings, perform the following:

1. Click **Date and Time** in the Advanced screen. The “Date and Time” screen appears.

Date and Time

Localization

Local Time: Dec 14, 2007 17:56:26

Time Zone: Pacific Time (GMT-08:00)

Daylight Saving Time

Enabled

Start: May 11 00 : 00

End: Nov 11 01 : 00

Offset: 60 Minutes

Automatic Time Update

Enabled

Protocol: Time Of Day (TOD) Network Time Protocol (NTP)

Update Every: 24 Hours [Sync Now](#)

Time Server	Action
ntp.actiontec.com	

Status: Waiting for response from server

Press the **Refresh** button to update the status.

[Apply](#) [Cancel](#) [Clock Set](#) [Refresh](#)

2. Select the local time zone from the drop-down list. The FiOS Router can automatically detect daylight saving setting for selected time zones. If the daylight saving settings for a time zone are not automatically detected, the following four fields will be displayed:
 - **Enabled** - Select this check box to enable daylight saving time.
 - **Start** - Date and time when daylight saving starts.
 - **End** - Date and time when daylight saving ends.
 - **Offset** - The amount of time daylight saving time changes.

To perform an automatic time update:

1. Click in the “Enabled” check box in the “Automatic Time Update” section.
2. Select the protocol to be used to perform the time update by selecting either the “Time of Day” or “Network Time Protocol” radio button.
3. Specify how often to perform the update in the “Update Every” text box.
4. Define time server addresses by clicking **Add** on the bottom of the “Automatic Time Update” section and entering the IP address or domain name of the time server in the “Time Server Settings” screen.

8.6b Clock Set

Click on this button at the bottom of the Date and Time screen (which generates the figure, below) to set the FiOS Router’s time and date.

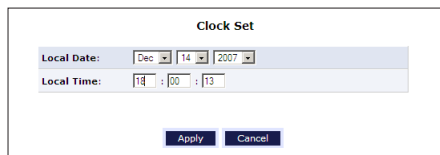

The screenshot shows a dialog box titled "Clock Set". It contains two input fields: "Local Date:" and "Local Time:". The "Local Date:" field is set to "Dec 14 2007". The "Local Time:" field is set to "18:00:13". At the bottom of the dialog box, there are two buttons: "Apply" and "Cancel".

8 Configuring Advanced Settings

8.6 Time Settings

8.6c Scheduler Rules

Scheduler rules are used for limiting the activation of firewall rules to specific time periods, either for days of the week, or for hours of each day. To define a rule:

1. Make sure the FiOS Router's date and time are set correctly. To do this, see the "Date and Time" section in this chapter.
2. Click **Scheduler Rules** in the Advanced screen. The "Scheduler Rules" screen appears.

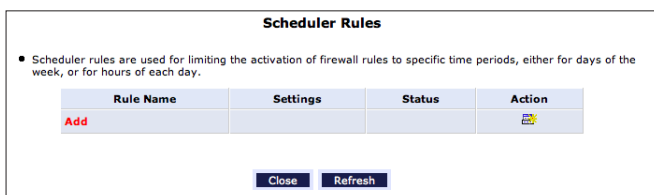

3. Click **Add**. The "Set Rule Schedule" screen appears.

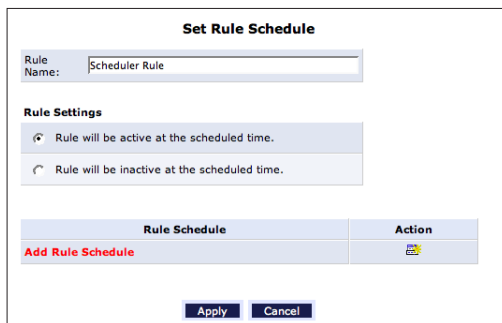

4. Enter a name for the rule in the "Rule Name" text box.
5. Specify if the rule will be active or inactive during the designated time period by clicking the appropriate "Rule Settings" radio button.

6. Click **Add Rule Schedule**. The “Edit Rule Schedule” screen appears.

Edit Rule Schedule

Days of Week

<input type="checkbox"/> Monday
<input type="checkbox"/> Tuesday
<input type="checkbox"/> Wednesday
<input type="checkbox"/> Thursday
<input type="checkbox"/> Friday
<input type="checkbox"/> Saturday
<input type="checkbox"/> Sunday

Hours Range

Start	End	Action
New Hours Range Entry		

7. Select or active or inactive days of the week by clicking in the appropriate text boxes.
8. If applicable, click **New Hours Range Entry** to define an active/inactive hourly range. The “Edit Hour Range” screen appears. Enter a start and end time in the appropriate text boxes.

Edit Hour Range

NOTE: Use military time to edit the hour range. (e.g. 2:30pm = 14:30)

Start time:	00	:00
End time:	00	:00

9. Click **Apply**.

Note: Make sure the FiOS Router’s date and time settings are properly configured for the time zone.

8.7 Firmware Upgrade/Restore

The FiOS Router offers a built-in mechanism for upgrading or restoring its firmware without losing custom configurations and settings. There are two methods for upgrading the firmware:

- **Upgrading from the Internet** - use this method to upgrade the FiOS Router's firmware by remotely downloading an updated software image file.
- **Upgrading from a local computer** - use a software image file pre-downloaded to the computer's disk drive to upgrade.

8.7a Upgrading From the Internet

The FiOS Router's firmware can be automatically updated via the Internet. From the drop-down list next to the globe icon near the top of the Firmware Upgrade screen, a list of options appears, as described below.

Automatically Check and Upgrade

If "Automatically Check for New Version and Upgrade Wireless Broadband Router" is selected, enter the period of time the FiOS Router checks for a new upgrade, and the URL at which to get the upgrade, in the appropriate text boxes. The FiOS Router will then check at each time interval for upgrades and, if one is available, upgrade the FiOS Router's firmware.

Automatically Check and Send E-mail

If "Automatically Check for New Version and Notify via Email" is selected, enter the period of time the FiOS Router checks for a new upgrade, and the URL at which to get the upgrade, in the appropriate text boxes. The FiOS Router will then check at each time interval for firmware upgrades and, if one is available, send an email to the address listed in the System Settings.

Automatic Check Disabled

If "Automatically Check Disabled" is selected, the FiOS Router will not automatically check for firmware upgrades.

Manual Checking and Upgrading

To manually upgrade the FiOS Router's firmware:

1. Click **Check Now** in the Firmware Upgrade screen.
2. If a new version is available, click **Force Upgrade**. A download process will begin. When downloading is completed, a confirmation screen appears, asking whether to upgrade to the new version.
3. Click **Apply**. The upgrade process will begin and should take no longer than one minute to complete.

At the conclusion of the upgrade process the FiOS Router automatically reboots. The new firmware runs, maintaining any custom configurations and settings.

8.7b Upgrading From a Local Computer

To upgrade from a local computer:

1. Click **Firmware Upgrade** from the Advanced screen. The "Firmware Upgrade" screen appears.

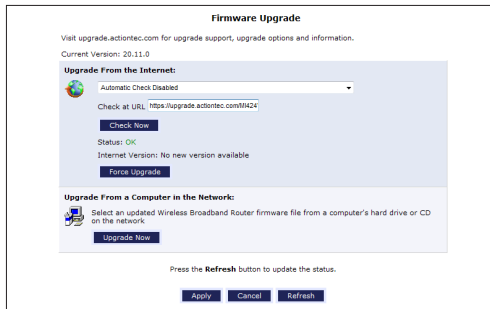

8 Configuring Advanced Settings

8.7 Firmware Upgrade/Restore

2. In the “Upgrade From a Computer in the Network” section, click **Upgrade Now**. The “Upgrade From a Computer in the Network” screen appears.



3. Enter the path of the software image file, or press the “Browse” button to browse for the file, and click **OK**. Make sure to only use files with an “rmt” extension when performing the firmware upgrade procedure.
4. When loading is completed, a confirmation screen appears, asking whether to upgrade to the new version. Click **Apply**. The upgrade process begins and should take no longer than one minute to complete.
5. When the upgrade process ends, the FiOS Router automatically reboots. The new firmware will run, maintaining any custom configurations and settings.

8.7c Firmware Restore

To restore the FiOS Router’s firmware to a previous version:

1. Click **Firmware Restore** from the Advanced screen. The “Firmware Restore” screen appears.



2. Check that the backup firmware listed is the desired firmware revision, then click **Restore Backup Firmware**. The FiOS Router’s firmware will be restored to the previous version.

8.8 Routing Settings

The final section of the Advanced screen is Routing settings, which includes Routing and IP Address Distribution.

8.8a Routing

Access the routing table rules by clicking **Routing** in the Advanced screen. The “Routing” screen appears.

Routing

- This page provides the ability to add, edit, or delete routing rules.

Routing Table

Name	Destination	Gateway	Netmask	Metric	Status	Action
New Route						

Routing Protocols

Internet Group Management Protocol (IGMP)

Domain Routing (add route entry according to interface from which DNS record is received)

Apply **Cancel**

Routing rules can be added, edited, or deleted from the Routing screen. To add a router, click **New Route**. The “Route Settings” screen appears.

Route Settings

Name: Network (Home/Office)

Destination: 0 0 0 0

Netmask: 255 255 255 255

Gateway: 0 0 0 0

Metric: 0

Apply **Cancel**

When adding a routing rule, the following parameters must be specified:

- **Rule Name** - Select the type of network from the drop-down list.
- **Destination** - The destination is the destination host, subnet address, network address, or default route. The destination for a default route is 0.0.0.0.

8 **Configuring Advanced Settings**

8.8 Routing Settings

- **Netmask** - The network mask is used in conjunction with the destination to determine when a route is used.
- **Gateway** - Enter the FiOS Router's IP address.
- **Metric** - A measurement of the preference of a route. Typically, the lowest metric is the most preferred route. If multiple routes exist to a given destination network, the route with the lowest metric is used.

IGMP (Internet Group Management Protocol) Multicasting

The FiOS Router provides support for IGMP multicasting. A multicast is simply a message that is sent simultaneously to a pre-defined group of recipients. When joining a multicast group, all messages addressed to the group will be received by the user, much like when an email message is sent to a mailing list. To activate IGMP multicasting:

1. Select **Routing** in the Advanced screen.
2. Activate the "Internet Group Management Protocol" check-box.
3. Click **Apply**.

Domain Routing

Domain routing is used in multi-router local network configurations. Normally, to access a device connected to one router from another router on the network, its IP address must be used. Activating domain routing (by clicking in the appropriate check box) allows the user access to the computer by name (as well as IP address).

8.8b IP Address Distribution

The FiOS Router's DHCP server makes it possible to easily add computers configured as DHCP clients to the network. It provides a mechanism for allocating IP addresses to these hosts and for delivering network configuration parameters to them.

For example, a client (host) sends out a broadcast message on the network requesting an IP address for itself. The DHCP server then checks its list of available addresses and leases a local IP address to the host for a specific period of time and simultaneously designates this IP address as "taken." At this point, the host is configured with an IP address for the duration of the lease.

The host can choose to renew an expiring lease or let it expire. If it chooses to renew a lease, it will also receive current information about network services, as it did with the original lease, allowing it to update its network configurations to reflect any changes that occurred since it first connected to the network. If the host wishes to terminate a lease before its expiration, it can send a release message to the DHCP server, which will then make the IP address available for use by others.

The FiOS Router’s DHCP server:

- displays a list of all DHCP hosts devices connected to the FiOS Router;
- defines the range of IP addresses that can be allocated in the network;
- defines the length of time for which dynamic IP addresses are allocated;
- provides the above configurations for each network device and can be configured and enabled/disabled separately for each network device;
- can assign a static lease to a network computer to receive the same IP address each time it connects to the network, even if this IP address is within the range of addresses that the DHCP server may assign to other computers;
- provides the DNS server with the host name and IP address of each computer connected to the network.

To view a summary of the services currently being provided by the DHCP server, click **IP Address Distribution** in the Advanced screen. The “IP Address Distribution” screen appears.

IP Address Distribution

• IP Address Distribution provides the ability to allocate IP addresses and configuration parameters to selected hosts

Name	Service	Subnet Mask	Dynamic IP Range	Action
Network (Home/Office)	DHCP Server	255.255.255.0	192.168.1.2 - 192.168.1.254	

Close
Connection List
Access Control

Editing DHCP Server Settings

To edit the DHCP server settings for a device:

1. Click the appropriate icon in the “Action” column. The “DHCP Settings” screen for the device appears.

DHCP Settings for Network (Home/Office)

Service

IP Address Distribution: DHCP Server

DHCP Server

Start IP Address: 192.168.1.0

End IP Address: 192.168.1.254

Subnet Mask: 255.255.0.0

WINS Server: 0.0.0.0

Lease Time in Minutes: 1440

Provide Host Name If Not Specified by Client

IP Address Distribution According to DHCP Option 60 (Vendor Class Identifier)

Vendor Class ID	IP Address	MAC Address	QoS
-----------------	------------	-------------	-----

Apply Cancel





2. Select the “IP Address Distribution” from the drop-down list. Options include DHCP Server, DHCP Relay, or Disable.
3. Complete the following fields:
 - **Start IP Address Range, End IP Address Range** - determines the number of hosts connected to the network in this subnet. “Start” specifies the first IP address assigned in this subnet and “End” specifies the last IP address in the range.
 - **Subnet Mask** - used to determine to which subnet an IP address belongs. An example of a subnet mask value is 255.255.0.0.
 - **WINS Server** - The WINS (Windows Internet Naming Service) server determines the IP address associated with a network device.
 - **Lease Time** - each device will be assigned an IP address by the DHCP server for a limited time (“Lease Time”) when it connects to the network. When the lease expires, the server will determine if the computer has disconnected from the network. If it has, the server may reassign this IP address to a newly-connected computer. This feature ensures that IP addresses not in use will become available for other computers on the network.

- **Provide host name if not specified by client** - when activated, the FiOS Router assigns the client a default name if the DHCP client has no host name.

4. Click **Apply** to save the changes.

DHCP Connections

To view a list of computers currently recognized by the DHCP server, click **Connection List** at the bottom of the IP Address Distribution screen. The “DHCP Connections” screen appears.

DHCP Connections							
Host Name	IP Address	Physical Address	Lease Type	Connection Name	Status	Expires In	Action
gateway2	192.168.1.2	00:90:27:b3:ce:49	Dynamic	Network (Home/Office)	Active	9931 minutes	  
New Static Connection							

Press the **Refresh** button to update the data.

To define a new connection with a fixed IP address:

1. Click **New Static Connection** in the DHCP Connections screen. The “DHCP Connection Settings” screen appears.

DHCP Connection Settings	
Host Name:	<input type="text" value="new-host"/>
IP Address:	<input type="text" value="0"/> <input type="text" value="0"/> <input type="text" value="0"/> <input type="text" value="0"/>
MAC Address:	<input type="text" value="00"/> <input type="text" value="00"/> <input type="text" value="00"/> <input type="text" value="00"/> <input type="text" value="00"/> <input type="text" value="00"/>

2. Enter a host name for this connection.
3. Enter the fixed IP address to assign to the computer.

8 **Configuring Advanced Settings**

8.8 Routing Settings

4. Enter the MAC address of the computer's network card.
5. Click the **Apply** to save changes.

Note: A device's fixed IP address is actually assigned to the specific network card's MAC address installed on the network computer. If this network card is replaced, the device's entry in the DHCP Connections list must be updated with the new network card's MAC address.

To remove a host from the table, click the appropriate "Delete" icon in the Action column.

9

- 9.0** Introduction
- 9.1** Router Status
- 9.2** Advanced Status

Monitoring the FiOS Router

The FiOS Router's System Monitoring screens display important system information, including basic router settings, system log, key network device parameters, and network traffic statistics.

9.1 Router Status

Click **System Monitoring** at the top of the Home screen to display the “Router Status” screen, which displays the FiOS Router’s basic settings.

Router Status	
Firmware Version:	40.19.2
Model Name:	M1424WR-GEN3I
Hardware Version:	1
Serial Number:	222
Physical Connection Type:	
Broadband Connection Type:	
Broadband Connection Status:	Disconnected
Broadband IP Address:	
Subnet Mask:	0.0.0.0
Broadband MAC Address:	00:0F:B3:A7:A9:07
Default Gateway:	
DNS Server:	
Active Status (Router Has Been Active For):	0 hours, 18 minutes

9.2 Advanced Status

After selecting **Advanced Status** and clicking **Yes** in the Warning screen, the monitoring options appear: **System Logging**, **Full Status/System wide Monitoring of Connections**, **Traffic Monitoring**, **Broadband Monitoring**, and **IGMP Proxy**.

Advanced Status

Click on the link you wish to view
NOTE: Only advanced technical users should use this feature.



- System Logging**
- Full Status/System wide Monitoring of Connections**
- Traffic Monitoring**
- Broadband Monitoring**
- IGMP Proxy**

9 Monitoring the FiOS Router

9.2 Advanced Status

9.2a System Logging

Click **System Logging** in the Advanced Status screen to generate the “System Log” screen. The System Log displays a list of the most recent activities of the FiOS Router.

System Log

[Close](#) [Save Log](#) [Refresh](#)

Press the **Refresh** button to update the data.

Time	Event	Event-Type	Details
Dec 14 19:00:38 2007	System Log	LAN DHCP	DHCP LAN Connection IP:192.168.1.3, DNS:192.168.1.1;GTW:192.168.1.1;Subnet:255.255.255.0 (Ethernet)

[Close](#) [Advanced =>](#)

9.2b Full Status/System wide Monitoring of Connections

1. Click **Full Status/System wide Monitoring of Connections** in the Advanced Status screen (and click through the Warning screen) to generate the “Full Status/System wide Monitoring of Connections” screen, which features a table summarizing the monitored connection data.
2. Click **Refresh** to update the table, or click **Automatic Refresh On** to constantly update the displayed parameters.

Full Status/System wide Monitoring of Connections					
Name	Network (Home/Office)	Ethernet/Coax	Broadband Connection (Ethernet/Coax)	Wireless Access Point	WAN PPPoE
Status	Connected	Connected	Cable Disconnected	Disconnected	Disabled
Network	Network (Home/Office)	Network (Home/Office)	Broadband Connection	Network (Home/Office)	Broadband Connection
Underlying Device	Ethernet/Coax Wireless Access Point				Broadband Connection (Ethernet/Coax)
Connection Type	Bridge	Hardware Ethernet Switch	Ethernet/Coax	Wireless 802.11n Access Point	PPPoE
MAC Address	00:0f:b3:a7:a9:06	00:0f:b3:a7:a9:0a	00:0f:b3:a7:a9:07	00:0f:b3:a7:a9:09	
IP Address	192.168.1.1				
Subnet Mask	255.255.255.0				
IP Address Distribution	DHCP Server	Disabled	Disabled	Disabled	
Service Name					
User Name					verizonfos
Received Packets	8322	8322		0	
Sent Packets	9046	20605		429	
Received Bytes	2539358	2655866		0	
Sent Bytes	5510978	6381748		114497	
Receive Errors	0	0		0	
Receive Drops	0	0		0	
Time Span	1:17:01	1:17:01		1:16:58	
Channel	Cable Disconnected	Cable Disconnected	Cable Disconnected	Cable Disconnected	

Close Automatic Refresh On Reset Statistics Refresh

9 Monitoring the FiOS Router

9.2 Advanced Status

9.2c Traffic Monitoring

The FiOS Router constantly monitors traffic within the local network and between the local network and the Internet. To view up-to-the-second statistical information about data received from and transmitted to the Internet, and about data received from and transmitted to computers in the local network, click **Traffic Monitoring** in the Advanced Status screen. This generates the “Traffic Monitoring” screen.

Traffic Monitoring					
Name	Network (Home/Office)	Ethernet/Coax	Broadband Connection (Ethernet/Coax)	Wireless Access Point	WAN PPPoE
Status	Connected	Connected	Cable Disconnected	Disconnected	Disabled
Network	Network (Home/Office)	Network (Home/Office)	Broadband Connection	Network (Home/Office)	Broadband Connection
Underlying Device	Ethernet/Coax Wireless Access Point				Broadband Connection (Ethernet/Coax)
Connection Type	Bridge	Hardware Ethernet Switch	Ethernet/Coax	Wireless 802.11n Access Point	PPPoE
IP Address	192.168.1.1				
Received Packets	6114	6114		0	
Sent Packets	6601	9905		235	
Received Bytes	1902060	1987656		0	
Sent Bytes	4107348	4423708		47327	
Receive Errors	0	0		0	
Receive Drops	0	0		0	
Time Span	0:21:59	0:21:59		0:21:55	
<div style="text-align: center;"> Close Automatic Refresh On Reset Statistics Refresh </div>					

9.2d Bandwidth Monitoring

To monitor the FiOS Router’s bandwidth use, click **Bandwidth Monitoring**. The “Bandwidth Monitor” screen appears.

Bandwidth Monitoring								
The recorded bandwidth usage will be measured in Kbps.								
Last Minute	1 Minute	2 Minutes	3 Minutes	4 Minutes	5 Minutes	6 Minutes	7 Minutes	8 Minutes
Tx Rate	0	0	0	0	0	0	0	0
Rx Rate	0	0	0	0	0	0	0	0
Last Hour	1 Hour	2 Hours	3 Hours	4 Hours	5 Hours	6 Hours	7 Hours	8 Hours
Tx Rate	0	0	0	0	0	0	0	0
Rx Rate	0	0	0	0	0	0	0	0
<div style="text-align: center;"> Close Automatic Refresh On Refresh </div>								

9.2e IGMP Proxy

To monitor the FiOS Router's IGMP Proxy settings, click **IGMP Proxy**. The "IGMP Host Multicast Group Membership" screen appears, giving the user an overview of the IGMP Proxy status on the FiOS Router. For more information about how to set up IGMP proxy on the FiOS Router, see section 8.4e ("IGMP Proxy"). For more information about the FiOS Router's IGMP multicasting capabilities, see "IGMP Multicasting" in section 8.8 ("Routing Settings").

10

- 10.0** Introduction
- 10.1** Troubleshooting Tips
- 10.2** Frequently Asked Questions

Troubleshooting

This chapter lists a selection of problems that may be encountered while using the FiOS Router, and offers suggestions that may overcome them. Note that these suggestions may not solve the problem (or problems). Also included is a list of frequently asked questions.

10.1 Troubleshooting Tips

Accessing the FiOS Router if Locked Out

If the FiOS Router's connection is lost while making configuration changes, a setting that locks access to the FiOS Router's GUI may have inadvertently been activated. There are three common ways to lock access to the FiOS Router:

Scheduler If a schedule has been created that applies to the computer over the connection being used, the FiOS Router will not be accessible during the times set in the schedule. To regain access, either wait until the connection is scheduled to be active again, or restore the default settings to the FiOS Router.

LAN Firewall If the firewall setting for the local network is set to maximum, no computers from the network will be able to connect to the FiOS Router. To gain access, restore the default settings to the FiOS Router.

Access Control If the access control setting for the computer is set to block the computer, access to the FiOS Router will be denied. To gain access, restore the default settings to the FiOS Router.

Restoring the FiOS Router's Default Settings

There are two ways to restore the FiOS Router's default settings. The first is to use the tip of a ballpoint pen and press and hold the "Reset" button on the back of the FiOS Router for at least ten seconds. The second is to access the FiOS Router's GUI and navigate to the "Advanced Settings" screen. Click **Restore Defaults** and read the instructions on-screen. Note that after performing either of these two procedures, all previously saved settings on the FiOS Router will be lost.

LAN Connection Failure

- Ensure the FiOS Router is properly installed, the LAN connections are correct, and the power is on.
- Confirm the computer and FiOS Router are on the same network segment. If unsure, let the computer get the IP address automatically by initiating the DHCP function, then verify the computer is using an IP address within the default range (192.168.1.2 through 192.168.1.254). If the computer is not using an IP address within the range, it will not connect to the FiOS Router.
- Ensure the Subnet Mask address is set to 255.255.255.0.

Time out error occurs when entering a URL or IP Address

- Verify all the computers are working properly.
- Ensure the IP settings are correct.
- Ensure the FiOS Router is on and connected properly.
- Verify the FiOS Router's settings are the same as the computer.

10.2 Frequently Asked Questions

I've run out of Ethernet ports on my FiOS Router. How do I add more computers?

Plugging in an Ethernet hub or switch expands the number of ports on the FiOS Router. Run a standard Ethernet cable from the "Uplink" port of the new hub or switch to a yellow Ethernet port on the FiOS Router.

How do I change the password on the FiOS Router's Graphical User Interface?

From the FiOS Router's GUI Home screen, click **Advanced**, then **Users**. From the "Users" screen, click **Administrator**, which generates the "User Settings" screen. In the "General" section of the screen, change the password.

Is the wireless option on by default on the FiOS Router?

Yes. The FiOS Router's wireless option is activated out of the box.

Is the wireless security on by default when the wireless option is activated?

Yes, with a unique WPA (Wi-Fi Protected Access) key that is printed on the sticker on the back of the FiOS Router.

Which connection speeds does the FiOS Router support?

The Ethernet Internet connection supports 100 Mbps. The LAN Ethernet connections support 10/100/1000 Mbps. The 802.11n wireless connection supports up to 160 Mbps (depending on signal quality, etc.). The MoCA connection supports 270 Mbps.

Are the FiOS Router's Ethernet ports auto-sensing?

Yes. Either a straight-through or crossover Ethernet cable can be used.

Can I use an 802.11b wireless card to connect to the FiOS Router?

Yes, the FiOS Router can interface with 802.11b, g, or n cards. The FiOS Router can be setup to handle only n wireless cards, g wireless cards, b wireless cards, or any combination of the three.

Can my wireless signal pass through floors, walls, and glass?

The physical environment surrounding the FiOS Router can have a varying effect on signal strength and quality. The more dense the object (a concrete wall compared to a plaster wall, for example), the greater the interference. Concrete or metal-reinforced structures will experience a higher degree of signal loss than those made of wood, plaster, or glass.

How do I find out what IP address my computer is using?

Windows 7 - Click the Windows button and select **Control Panel**. In the Control Panel, click **View Network Status and Tasks**. In the next window, click **Local Area Connection**. In the "Local Area Connection Status" window, click **Details**.

Windows Vista - Click the Windows button and select **Control Panel**. In the Control Panel, click **Network and Sharing Center**. In the "Network and Sharing Center" window, click **View Status**. In the "Local Area Connection Status" window, click **Details**.

Windows 2000, XP - Select **Start, Run** and type "cmd." Press **Enter**. When the command screen appears, type "ipconfig" and press **Enter**.

My computer cannot connect to the Internet via MoCA. What should I do?

First, check the connection, and make sure all cables are connected correctly. Then make sure the NIM is still connected, and check the Ethernet connection to the NIM from the computer. A computer cannot be connected directly via a MoCA cable; it must go through a NIM to connect. The NIM converts the MoCA signal to an Ethernet signal the computer can understand.

I used DHCP to configure my network. Do I need to restart my computer to refresh my IP address?

No. Follow these steps to refresh the IP address:

Windows 7, Vista, XP - Unplug the Ethernet cable or wireless card and plug it back in.

Windows 2000 - Select **Start, Run**, type "cmd," and press **Enter**. At the DOS prompt, type "ipconfig /release" and press **Enter**, then type "ipconfig /renew" and press **Enter**.

I cannot access the FiOS Router's Graphical User Interface? What should I do?

If you cannot access the FiOS Router's Graphical User Interface (GUI), make sure the computer connected to the FiOS Router is set up to dynamically receive an IP address.

I have an FTP or Web server on my network. How can I make it available to users on the Internet?

For a Web server, enable port forwarding for port 80 to the IP address of the server. Also, set up the Web server to receive on that port. (Configuring the server to use a static IP address is recommended.)

For an FTP server, enable port forwarding for port 21 to the IP address of the server. (Configuring the server to use a static IP address is recommended.)

How many computers can be connected through the FiOS Router?

The FiOS Router is capable of 254 connections, but we recommend having no more than 45 connections. As the number of connections increase, the available speed for each computer decreases.

What is the default user name for the FiOS Router?

The default user name for the FiOS Router is "admin" (all lower case, no quotation marks). When logging into the FiOS Router the first time (or after restoring the FiOS Router's default settings), the user is asked to create a new user name and password. Enter the new user name and password, write them down on a piece of paper, and keep it in a safe place. The new user name and password will be needed to access the FiOS Router's GUI in the future.

A

- A.0** Introduction
- A.1** Traffic Priority
- A.2** Traffic Shaping

Configuring Quality of Service

Quality of Service refers to the capability of a network device to provide better service to selected network traffic. This is achieved by shaping the traffic and processing higher priority traffic before lower priority traffic. The FiOS Router provides several different methods of configuring Quality of Service.

STOP! Do not change any Quality of Service settings unless instructed to do so by the ISP.

A.1 Traffic Priority

Traffic Priority manages and avoids traffic congestion by defining inbound and outbound priority rules for each device on the FiOS Router. These rules determine the priority that packets, traveling through the device, will receive. QoS parameters (DSCP marking and packet priority) are set per packet, on an application basis.

QoS can be configured using flexible rules, according to the following parameters:

- Source/destination IP address, MAC address, or host name
- Device
- Source/destination ports
- Limit the rule for specific days and hours

The FiOS Router supports two priority marking methods for packet prioritization:

- DSCP
- 802.1p Priority

The matching of packets by rules is connection-based, known as Stateful

Packet Inspection (SPI), using the FiOS Router's firewall mechanism. Once a packet matches a rule, all subsequent packets with the same attributes receive the same QoS parameters, both inbound and outbound. Connection-based QoS also allows inheriting QoS parameters by some of the applications that open subsequent connections. For instance, QoS rules can be defined on SIP, and the rules will apply to both control and data ports (even if the data ports are unknown). Applications that support such inheritance have an ALG in the firewall. They are:

- SIP
- MSN Messenger/Windows Messenger
- TFTP
- FTP
- MGCP
- H.323
- Port triggering applications
- PPTP
- IPSec

A.1a Setting Traffic Priority Rules

To set traffic priority rules:

1. Click **Quality of Service** in the Advanced screen. The “Traffic Priority” screen appears, which lists all the devices on which rules can be set.

The screenshot shows the "Traffic Priority" configuration page. It contains two tables: "QoS Input Rules" and "QoS Output Rules". Both tables have columns for Rule ID, Source Address, Destination Address, Match, Operation, Status, and Action. Under each table, there are rows for "Network (Home/Office) Rules", "Ethernet/Coax Rules", "Broadband Connection (Ethernet/Coax) Rules", and "Wireless Access Point Rules". Each of these rows has an "Add" button to its right. At the bottom of the page, there are four buttons: "Apply", "Cancel", "Resolve Now", and "Refresh".

2. Click **Add** in the appropriate row. The “Add Traffic Priority Rule” screen appears.

The screenshot shows the "Add Traffic Priority Rule" configuration page. It includes several sections:

- Matching:**
 - Source Address: Any (dropdown)
 - Destination Address: Any (dropdown)
 - Protocol: Any (dropdown)
 - DSCP
 - Priority
 - Length
- Operation:**
 - Set DSCP
 - Set Priority
 - Set Rx Class Name: No RX class names available
 - Set Tx Class Name: No TX class names available
 - Apply QoS on: Connection (dropdown)
- Logging:**
 - Log Packets Matched by This Rule
- When should this rule occur?:** Always (dropdown)

 At the bottom, there are "Apply" and "Cancel" buttons.

3. Select an option from the “Source Address” drop-down list. If selecting “Specify IP,” enter the IP address in the appropriate “IP Address” text box.
4. Select an option from the “Destination Address” drop-down list. If selecting “Specify IP,” enter the IP address in the appropriate “IP Address” text box.

5. From the "Protocol" drop-down list, select a protocol option.
6. If applicable, activate the "DSCP," "Priority," and "Length" check boxes.
7. If applicable, select an option from the "Source Ports" and "Destination Ports" drop-down lists.
8. Click in the "Set DSCP" check box to mark a DSCP value on packets matching a connection that matches this rule, then enter the Hex value of the DSCP in the appropriate text box.
9. Click in the "Set Priority" check box to add a priority to the rule, then select one of the eight priority levels. Zero is the lowest priority, and seven the highest (each priority level is mapped to low/medium/high priority). This sets the priority of a packet on the connection matching the rule, while routing the packet.
10. If applicable, select the Rx Class and Tx Class names.
11. From the "Apply QoS on" drop-down menu, select whether to apply QoS on a connection or on packets.
12. Click in the "Logging" check box to add entries relating to this rule to the security log.
13. If this rule needs to be active constantly, select **Always** from the "When should this rule occur?" drop-down list. If the rule will only be active at certain times, select **User Defined** and click **Add**. Then, add a schedule rule (for more details about schedule rules, see the "Advanced Settings" chapter of this manual).

A.2 Traffic Shaping

Traffic Shaping is the solution for managing and avoiding congestion where the network meets limited broadband bandwidth. Typical networks use a 100 Mbps Ethernet LAN with a 100 Mbps WAN interface router, which is where most bottlenecks occur.

A traffic shaper is essentially a regulated queue that accepts uneven and/or bursty flows of packets and transmits them in a steady, predictable stream so that the network is not overwhelmed with traffic. While traffic priority allows basic prioritization of packets, traffic shaping provides more sophisticated definitions, such as:

- Bandwidth limit for each device
- Bandwidth limit for classes of rules
- Prioritization policy
- TCP serialization on a device

Additionally, QoS traffic shaping rules can be defined for a default device. These rules will be used on a device that has no definitions of its own. This enables the definition of QoS rules on the default WAN, for example, and their maintenance even if the PPP or bridge device over the WAN is removed.

A.2a Device Traffic Shaping

This section describes the different Traffic Shaping screens and terms, and presents the feature's configuration logic.

1. Click **Quality of Service** in the Advanced screen, then click **Traffic Shaping**. The following screen appears.

Traffic Shaping				
Device	Tx Bandwidth (Kbps)	Rx Bandwidth (Kbps)	TCP Serialization	Action
Add				

- Click **Add**. The “Add Device Traffic Shaping” screen appears.

Add Device Traffic Shaping

Device: Default WAN device

- Select the device for which the traffic will be shaped. The drop-down list includes all the FiOS Router’s devices.
- Click **Apply**. The “Edit Device Traffic Shaping” screen appears.

Edit Device Traffic Shaping

Device: Network (Home/Office)

Tx Traffic Shaping

Tx Bandwidth: Specify 1147460 Kbps

TCP Serialization: Disabled

Queue Policy: Class Based

Class ID	Name	Priority	Bandwidth		Status	Action
			Reserved	Maximum		
default	default	4	0 Kbps	Unlimited	Active	
Add						

Rx Traffic Policing

Rx Bandwidth: Specify 1147460 Kbps

Class ID	Name	Bandwidth		Status	Action
		Reserved	Maximum		
Add					

- Select **Specify** or **Unlimited** from the “Tx Bandwidth” drop-down list. If **Specify** is selected, enter the bandwidth amount (in Kbps) in the appropriate text box.
- Enable or disable “TCP Serialization” by selecting the appropriate option from the drop-down list.
- Select a “Queue Policy” from the drop-down list (either **Class Based** or **Strict Priority**).

- If "Class Based" was selected in step 7, shaping classes can be configured. To do this, select an existing shaping class from the "Name" column in the "Tx Traffic Shaping" section of the Edit Device Traffic Shaping screen. An "Edit Shaping Class" screen appears, where the "Class Priority" and the shaping "Policy" can be configured. When finished, click **Apply**.

Edit Shaping Class

Name:	default
Class Priority:	4
Bandwidth:	Reserved 0 Maximum Unlimited
Policy:	Priority

- To add a shaping class, click **Add** in the Queue Policy section of the Edit Device Traffic Shaping screen. An "Add Shaping Class" screen appears. Enter the name of the new shaping class in the "Name" text box, then click **Apply**. To configure the parameters of the new shaping class, follow the instructions in step 8, above.

Add Shaping Class

Name:	Class
--------------	-------

- Traffic policing can also be configured from the Edit Device Traffic Shaping screen. To do this, select an existing policing class from the "Name" column in the "RX Traffic Policing" section of the Edit Device Traffic Shaping screen. An "Edit Policing Class" screen appears, where the bandwidth of the policing class can be reserved or set to a maximum amount. In the "When should this rule occur?" list box, a schedule for when the policing class will be active can be created. When finished, click **Apply**.

Edit Policing Class

Name:	class b
Bandwidth:	Reserved 0 Maximum Unlimited Kbps
When should this rule occur?	Always

11. To add a policing class, click **Add** in the “Rx Traffic Policing” section of the Edit Device Traffic Shaping screen. An “Add Policing Class” screen appears. Enter the name of the new policing class in the “Name” text box, then click **Apply**. To configure the parameters of the new policing class, follow the instructions in step 10, above.



The screenshot shows a dialog box titled "Add Policing Class". It contains a text input field with the label "Name:" and the placeholder text "Class". Below the input field are two buttons: "Apply" and "Cancel".

12. When finished with all device traffic shaping, click **Apply** in the Edit Device Traffic Shaping screen.

A.2c Ingress Data

The FiOS Router can control outgoing data fairly easily. It can queue packets, delay them, give precedence to other packets, or drop them. This helps in resolving upload (Tx) traffic bottlenecks, and in most cases is sufficient. However, in the case of download (Rx) traffic bottlenecks, the ability to control the flow is much more limited. The FiOS Router cannot queue packets, since in most cases the local network (LAN) is much faster than the Internet (WAN), and when the FiOS Router receives a packet from the Internet, it passes it immediately to the local network.

QoS for ingress data has the following limitations, which do not exist for outgoing data:

- QoS can only be applied to TCP streams (UDP streams cannot be delayed);
- no borrowing mechanism;
- and when reserving Rx bandwidth, it is strictly taken from the bandwidth of all other classes.

Furthermore, the FiOS Router cannot control the behavior of the ISP, which may not have proper QoS handling. Unfortunately, this is a common situation. Let's look at a scenario of downloading a large file and surfing the Internet at the same time. Downloading the file is distinguished by small requests, followed by very large responses. This may result in blocking HTML traffic at the ISP. A solution for such a situation is limiting the bandwidth of low-priority TCP connections (such as the file download).

A.2d Differentiated Services Code Point Settings



































In order to understand what DSCP is, one must first be familiarized with the Differentiated Services model.

Differentiated Services (Diffserv) is a Class of Service (CoS) model that enhances best-effort Internet services by differentiating traffic by users, service requirements, and other criteria. Packets are specifically marked, allowing network nodes to provide different levels of service, as appropriate for voice calls, video playback, or other delay-sensitive applications, via priority queuing or bandwidth allocation, or by choosing dedicated routes for specific traffic flows.

Diffserv defines a field in IP packet headers referred to as the Differentiated Services Codepoint (DSCP). Hosts or routers passing traffic to a Diffserv-enabled network will typically mark each transmitted packet with an appropriate DSCP. The DSCP markings are used by Diffserv network routers to appropriately classify packets and to apply particular queue handling or scheduling behavior.

The FiOS Router provides a table of predefined DSCP values, which are mapped to 802.1p priority marking method. Any of the existing DSCP setting can be edited or deleted, and new entries can be added.

1. Click **Quality of Service** at the top of the Home screen, then click **DSCP Settings**. The “DSCP Settings” screen appears.

DSCP Value (hex)	802.1p Priority	Action
0x0	0 (Queue 0 - Low)	 
0x2	0 (Queue 0 - Low)	 
0x4	4 (Queue 1 - Medium)	 
0x6	4 (Queue 1 - Medium)	 
0x8	2 (Queue 0 - Low)	 
0xA	1 (Queue 0 - Low)	 
0xC	3 (Queue 0 - Low)	 
0xE	2 (Queue 0 - Low)	 
0x10	7 (Queue 2 - High)	 
0x12	6 (Queue 2 - High)	 
0x14	7 (Queue 2 - High)	 
0x16	6 (Queue 2 - High)	 
0x18	5 (Queue 1 - Medium)	 
0x1A	5 (Queue 1 - Medium)	 
0x1C	5 (Queue 1 - Medium)	 
0x1E	5 (Queue 1 - Medium)	 
0x2E	7 (Queue 2 - High)	 
Add		

[Close](#)

A Configuring Quality of Service

A.2 Traffic Shaping

- To edit an existing entry, click the appropriate icon in the “Action” column. To add a new entry, click **Add**. In either case, the “Edit DSCP Settings” screen appears.

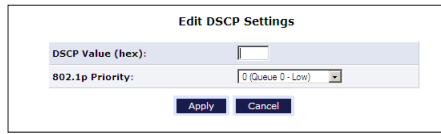

The screenshot shows a dialog box titled "Edit DSCP Settings". It has two input fields: "DSCP Value (hex):" with an empty text box, and "802.1p Priority:" with a dropdown menu showing "0 (Queue 0 - Low)". Below the fields are "Apply" and "Cancel" buttons.

- Configure the following parameters:

DSCP Value (hex) - Enter the DSCP value as a hexadecimal value.

802.1p Priority - Select a 802.1p priority level from the drop-down list, zero being the lowest and seven the highest (each priority level is mapped to low/medium/high priority). The default DSCP value for packets with an unassigned value is zero.

- Click **Apply** to save the settings.

A.2e 802.1p Settings

The IEEE 802.1p priority marking method is a standard for prioritizing network traffic at the data link/Mac sub-layer. 802.1p traffic is simply classified and sent to the destination, with no bandwidth reservations established.

The 802.1p header includes a 3-bit prioritization field, which allows packets to be grouped into eight levels of priority. By default, the highest priority is seven, which might be assigned to network-critical traffic. Values five and six may be applied to delay-sensitive applications such as interactive video and voice. Data classes four through one range from controlled-load applications down to “loss eligible” traffic. Zero is the value for unassigned traffic and used as a best effort default, invoked automatically when no other value has been set.

A packet can match more than one rule. This means that:

- The first class rule has precedence over all other class rules (scanning is stopped once the first rule is reached).

- The first traffic-priority (classless) rule has precedence over all other traffic priority rules.
 - There is no prevention of a traffic-priority rule conflicting with a class rule. In this case, the priority and DSCP setting of the class rule (if given) will take precedence.
1. Click **Quality of Service** in the Advanced screen, then click **802.1p Settings**. The “802.1p Settings” screen appears.

802.1p Settings	
802.1p Value	Queue
0	Queue 0 - Low ▼
1	Queue 0 - Low ▼
2	Queue 0 - Low ▼
3	Queue 0 - Low ▼
4	Queue 1 - Medium ▼
5	Queue 1 - Medium ▼
6	Queue 2 - High ▼
7	Queue 2 - High ▼

2. The eight 802.1p values are pre-populated with the three priority levels: **Low**, **Medium**, and **High**. These levels can be changed for each of the eight values in their respective drop-down lists.
3. Click **Apply** to save the settings.

A.2f Class Statistics

The FiOS Router provides accurate, real-time information on the traffic moving through the defined device classes. For example, the amount of packets sent, dropped, or delayed are just a few of the parameters monitored per each shaping class.

To view class statistics, click **Quality of Service** at the top of the Home screen, then click **Class Statistics**. The following screen appears. Note that class statistics will only be available after defining at least one class (otherwise the screen will not present any information).

Class Statistics						
Class	Packets Sent	Bytes Sent	Packets Dropped	Packets Delayed	Rate (bytes/s)	Packet Rate
Network (Home/Office)						
default	1002	675472	0	0	986	1
Class	0	0	0	0	0	0
Class 2	0	0	0	0	0	0

A.2g Class Identifier

To create a class identifier, click **Quality of Service** in the Advanced screen, then click **Class Identifier**. The “Class Identifier” screen appears.

Class Identifier	
DHCP Option 60 (Vendor Class Identifier):	<input type="text"/>
Start IP Address:	<input type="text"/> <input type="text"/> <input type="text"/> <input type="text"/>
End IP Address:	<input type="text"/> <input type="text"/> <input type="text"/> <input type="text"/>
<input checked="" type="checkbox"/> Set Priority	<input type="text" value="7 (Queue 2 - High)"/>

Enter the information needed in the appropriate text boxes, then click **Apply**.

B

- B.0** Introduction
- B.1** General
- B.2** LED Indicators
- B.3** Environmental

Specifications

This appendix lists the FiOS Router's specifications, including standards, cabling types, and environmental parameters.

Note that the specifications listed in this appendix are subject to change without notice.

B.1 General

Model Number

MI424WR rev. I (FiOS Router)

Standards

IEEE 802.3x, 802.3u

IEEE 802.11b, g, n (wireless)

IP

IP version 4

MoCA

Two channels (WAN, LAN)

WAN MoCA frequency: 975 MHz - 1025 MHz (single channel)

LAN MoCA frequency: 1125 MHz - 1425 MHz (6 channel)

Speed

Wired

LAN Ethernet: 10/100/1000 Mbps auto-sensing

Wireless

802.11b - up to 11 Mbps

802.11g - up to 54 Mbps

802.11n - up to 160 Mbps

Cabling Type

Ethernet 10BaseT: UTP/STP Category 3 or 5

Ethernet100BaseTX: UTP/STP Category 5

Ethernet1000BaseTX: UTP/STP Category 5e

Firewall

ICSA certified

B.2 LED Indicators

Power, WAN Ethernet, WAN Coax, Internet, LAN Ethernet (4), LAN Coax, USB (2), Wireless, WPS

B.3 Environmental Parameters

Dimensions

Size: 1.875" x 10" x 7.4"

Weight: 2.175 lbs.

Power

External, 12V DC, 1.8A (Adapter Technology Co., Ltd.; Model: STD-12018U1)

Certifications

FCC Part 15, UL 60950-1

Operating Temperature

0° C to 40° C (32° F to 104° F)

Storage Temperature

-20° C to 70° C (-4° F to 158° F)

Operating Humidity

8% to 93% (non-condensing)

Storage Humidity

5% to 100% (non-condensing)



- C.0** Introduction
- C.1** Regulatory
Compliance Notices
- C.2** Modifications
- C.3** NEBS Requirements
- C.4** GPL

Notices

This appendix lists various compliance and modification notices, as well as the NEBS requirements and GPL.

C.1 Regulatory Compliance Notices

Class B Equipment

This equipment has been tested and found to comply with the limits for a Class B digital device, pursuant to Part 15 of the FCC Rules. These limits are designed to provide reasonable protection against harmful interference in a residential installation. This equipment generates, uses, and can radiate radio frequency energy and, if not installed and used in accordance with the instructions, may cause harmful interference to radio communications. However, there is no guarantee that interference will not occur in a particular installation. If this equipment does cause harmful interference to radio or television reception, which can be determined by turning the equipment off and on, the user is encouraged to try to correct the interference by implementing one or more of the following measures:

- Reorient or relocate the receiving antenna;
- Increase the separation between the equipment and receiver;
- Connect the equipment to an outlet on a circuit different from the one to which the receiver is connected;
- Consult the dealer or an experienced radio or television technician for help.

C.2 Modifications

The FCC requires the user to be notified that any changes or modifications made to this device that are not expressly approved by Actiontec Electronics, Inc., may void the user's authority to operate the equipment.

Declaration of conformity for products marked with the FCC logo – United States only.

This device complies with Part 15 of the FCC Rules. Operation is subject to the following two conditions:

1. This device may not cause harmful interference;

2. This device must accept any interference received, including interference that may cause unwanted operation.

Note: To comply with FCC RF exposure compliance requirements, the antenna used for this transmitter must be installed to provide a separation distance of at least 20 cm from all persons and must not be co-located or operating in conjunction with any other antenna or transmitter.

For questions regarding your product or the FCC declaration, contact:

Actiontec Electronics, Inc.
760 North Mary Ave.
Sunnyvale, CA 94085
United States
Tel: (408) 752-7700
Fax: (408) 541-9005

C.3 NEBS Requirements

The coaxial cable screen shield must be connected to the Earth at the building entrance per ANSI/NFPA 70, the National Electrical Code (NEC), in particular Section 820.93, "Grounding of Outer Conductive Shield of a Coaxial Cable," or in accordance with local regulation.

Warning! The red WAN Coax Port is intended for connection to Verizon FiOS only. It must not be connected to any exterior or interior coaxial wires not designated for Verizon FiOS.

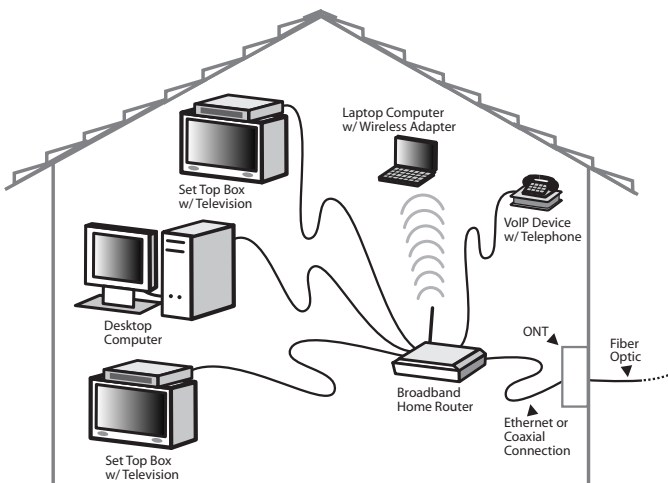

Typical Broadband Home Router Installation

Caution: The Broadband Home Router must be installed inside the home. The Router is not designed for exterior installation.

C.4 GPL (General Public License)

This product includes software code developed by third parties, including software code subject to the enclosed GNU General Public License (GPL) or GNU Lesser General Public License (LGPL). The GPL Code and LGPL Code used in this product are distributed WITHOUT ANY WARRANTY and are subject to the copyrights of the authors, and to the terms of the applicable licenses included in the download. For details, see the GPL Code and LGPL Code for this product and the terms of the GPL and the LGPL.